

# AUTOMATIC LUBRICATION EQUIPMENT

Buyer's Guide



PROVEN QUALITY. LEADING TECHNOLOGY.

CONSTRUCTION | FLEETS AND TRANSPORTATION | INDUSTRIAL | MINING | ENERGY | AGRICULTURE



# Table of Contents

	Page		Page
<b>About Graco</b> .....	4-6	<b>Metering</b>	
<b>Graco Resources</b> .....	6	How to Design a Metering Device System .....	110
<b>Mobile Equipment Kits</b>		Metering Device Selection Guide .....	111
Yellow Iron Selector Tool .....	7	Thrif-T Luber® .....	112
<b>Pumps</b>		Piston Distributors .....	113
Graco Buyer's Guidance: Pump Selection .....	9-10	GL-32™, GL-43™, GL-33™ and GL-42™ Injectors .....	114-116
Electric Pumps		GCI Injectors .....	117-118
Electric Pump Selection Guide .....	11-12	GL-1™ Injectors .....	119-121
G-Mini® Compact Pumps .....	13-14	GL-11 Injectors .....	122
G-Mini® / CSP Valve Kits .....	15	Compact Series Progressive (CSP) Valves .....	123-124
G3® Pumps .....	16-21	Trabon® MD Mono-Block Divider Valve .....	125
G-Series Pump Packages and Accessories .....	22-28	Trabon MJ Divider Valve .....	126-129
G3® Hammer Pump .....	29-30	Trabon MSP Divider Valve .....	130-136
G3® Dual-Line Pump .....	31-32	Trabon MSP Stainless Steel Divider Valve .....	137-142
G5™ Pumps .....	33-37	Manzel® MHH Divider Valve .....	143-147
Lube Master® .....	38-41	Trabon MX Divider Valve .....	148-151
Miniature Meter-Flo® .....	42-43	Trabon MXP Divider Valve .....	152-156
Meter-Flo® .....	44-45	Trabon MGO Divider Valve .....	157-160
Compact Dyna-Star® .....	46-47	Proximity Switches .....	161-162
GLC™ X Controller and Auto Lube™ App .....	47	Air Oil Manifold .....	163
Electric Dyna-Star® HP and Dyna-Star HF .....	48-51	<b>Accessories</b>	
Manzel® MBL Box Lubricators .....	52-56	Lubricant Spray .....	165
Pneumatic Pumps		Zone Valves .....	166
Pneumatic Pump Selection Guide .....	58	Reset Indicators .....	167
LubePro™ .....	59-63	Automatic Relief Indicator .....	168
LubriSystem .....	64-65	Rupture Indicator .....	169
Modu-Flo® .....	66-70	Rupture to Atmosphere Indicator .....	170
E-Series .....	71-72	Magnetic Visual Indicator .....	171
MSA-10 and MSA-100 .....	73-74	Broken Line Indicator .....	172
Pneumatic Dyna-Star® Fire-Ball® 300 50:1 .....	75-76	Filters .....	173-174
Hydraulic Pumps		Brushes .....	174
Hydraulic Pump Selection Guide .....	77	Installation Accessories	
Modu-Flo® .....	78	Straight and Angle Swivels .....	175-176
Hydraulic Dyna-Star® .....	79-82	Steel Fittings .....	177-182
Mechanical Pumps		Steel Swivel Adapters .....	183-184
Mechanical Pump Selection Guide .....	83	Steel JIC Fittings .....	185-190
Lube Master® Ratchet Drive .....	84-86	Stainless Steel Fittings .....	191-192
Manzel® MBL Box Lubricators .....	87-90	Stainless Steel Swivel Adapters .....	193
Manual Pumps		Stainless Steel JIC Fittings .....	194-196
Manual Pump Selection Guide .....	91	Check Valves .....	197-202
PH Pump .....	92-93	Pressure Sensors .....	203
LubriSystem .....	94	Pressure Gauges .....	204
<b>Controllers</b>		Other Fittings and Accessories .....	205-206
Controller Selection Guide .....	96-97	Hoses, Tubing and Fittings .....	207-219
GLC™ X Controller and Auto Lube™ App .....	98-99	<b>Manzel Systems</b>	
GLC™ 4400 Controller .....	100	MBL Box Lubricators .....	222-226
GLC™ 2200 Controller .....	101-102	MB Specialty Box Lubricators .....	227
Grease Jockey® Timer .....	103-104	GBL 7500 Pump .....	228
Solid State Timer .....	105	Model HP-15™ High Pressure Lubricators .....	229
Controller Accessories .....	106-107	Model HP-50™ High Pressure Lubricators .....	230
		MVB Pump .....	231
		MVB Box Lubricator Configurator .....	232
		Lube-Line Alert .....	233
		Pneumatic/Electric Lube Sentry Valve .....	234
		Balancing Valve .....	235
		<b>On-Road Lubrication</b>	
		Electric Grease Jockey® .....	237-239
		Electric Grease Jockey Manifolds .....	240
		Electric Grease Jockey Injectors .....	241
		Electric Grease Jockey Accessories .....	242-245
		Pneumatic Grease Jockey .....	246-248
		<b>Warranty Information</b> .....	249-251
		<b>Index</b> .....	252-263

# About Graco

Established in 1926, Graco has built a worldwide reputation for high quality, reliable and technically advanced products, world-class manufacturing and outstanding customer service. Headquartered in Minneapolis, Minnesota, Graco works closely with distributors around the world to offer innovative products that set the quality standard for spray finishing, paint circulation, lubrication, sealant and adhesives dispensing, process application and contractor power equipment. These best-in-class products are manufactured in the U.S. and China and supplied through our distribution centers around the world. Every day, Graco's fluid-handling equipment and systems move, measure, mix, control, dispense and spray a variety of fluids and materials.



## Lubrication Equipment Division

From the first air-powered grease gun to our industry-leading Fire-Ball pump, Graco's Lubrication Equipment Division is what started it all. We manufacture equipment to monitor, control, manage and dispense fluids. Offering innovative equipment for all your vehicle services, industrial and automatic lubrication needs.

Keep your equipment running at peak performance. Graco automatic lubrication solutions give you the ultimate machine performance by lubricating key wear points – the right amount of lubricant, at the right time, in the right location. Graco has automatic lubrication solutions for the industrial, on-road mobile, off-road mobile, energy industries and more. From light-duty applications to high-performance concepts designed for heavy-duty jobs, our equipment is known for its rugged, durable and long-life design.



**Machining** is a core competency of Graco – it enables complete control of the component parts needed to ensure precise metering, reliable dispensing and fluid movement.

When it comes to **research and development**, Graco is one step ahead, ensuring we offer the best possible solutions. To guarantee superior quality and to meet the changing requirements of your markets, we prioritize investing resources in research and development. Innovative technologies and extensive field testing are a natural part of our process to develop new products. Also, every aspect of our production is subject to constant testing and evaluation. It's the foundation to deliver products with long service life and low cost of ownership. The insurance to help you grow your business.



**We understand our customers.** We build a partnership, working and striving towards new solutions, together. We are at the service of our distribution partners, supporting you along the way. Look at Graco not just as a manufacturer or supplier but as an extension of your business. Our dedicated and experienced teams offer unique capabilities to help you meet your specific goals and challenges.

- Innovative, high-quality products with unique features
- A professional warranty and high service rate
- Purchasing conditions aimed at profitable growth
- A committed sales and marketing team for tailor-made support of expanding sales opportunities
- Continuous technical, commercial and hands-on training

Our world-class distribution centers and unrivaled global distributor network give Graco a unique industry advantage that allows us to rapidly deliver our products to end users worldwide.

Exceeding customer expectations is our priority. Our multilingual team of customer service specialists and technical engineers are available to you. Graco offers instructor-lead training sessions in the United States, EMEA and Asia Pacific. These courses teach theory and hands-on practical applications, covering basic operational to advanced technical knowledge. Each training session can be adapted to your specific needs.

Offering more than just products, we are focused on building relationships, identifying and developing business opportunities with you. Our sales team is available to collaborate, define strategies to assist in navigating through our product offering and provide advice on promotional activities.

Graco's marketing specialists investigate ways to expand the market and develop the right technologies for any application, in close cooperation with distributors and field users. We offer tailor-made

promotional and communication support, from defining strategic requirements to developing marketing campaigns, organizing events and creating digital or printed material.

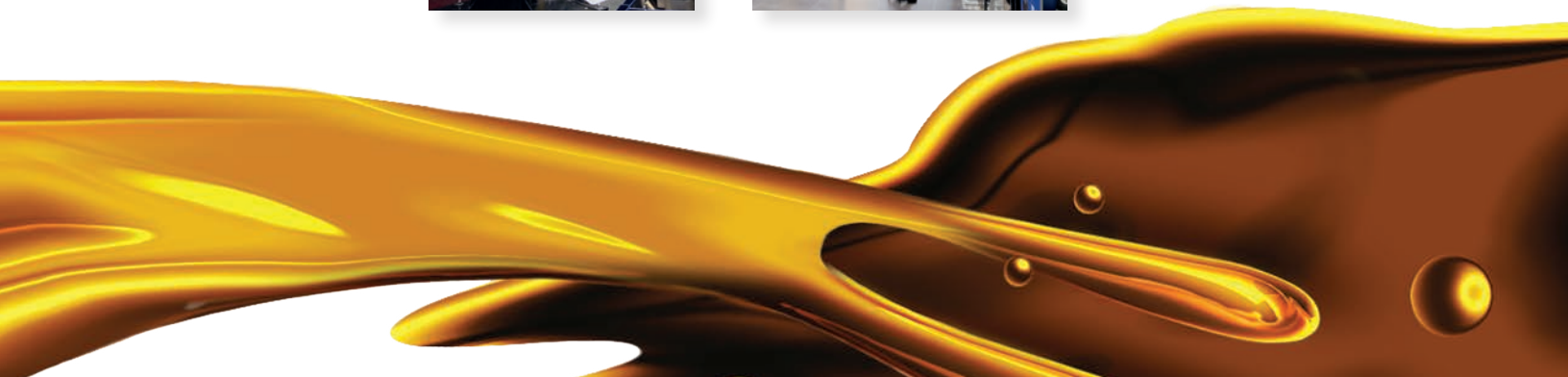

# Did You Know?

**Graco also manufactures and sells a complete line of high-quality pumps, meters, valves and hose reels!**



Graco offers a full line of quality equipment to meet the varying needs of vehicle maintenance and repair. Streamline your workflow and move more lubricants through your shop. We offer reliable, high-quality equipment you can depend on for fuel, diesel, antifreeze, oil and grease. Our versatile fluid inventory control and management systems are designed to accurately track the use of oil, grease and other automotive fluids at vehicle maintenance facilities, and our lubrication equipment ensures you deliver fluids to the right spot in your shop.



Visit [www.graco.com/vehicle-service](http://www.graco.com/vehicle-service)

## Graco Resources

Graco has developed tools and resources to help educate and better serve our distribution channel. Check them out today:



### Graco Sales Book

Stay up-to-date with the newest information from Graco by downloading the Graco Sales Book App.

Graco Sales Book is an innovative mobile application, designed to give Distributors access to Graco product information, including brochures, instruction manuals, videos and training documents – all on your mobile device.

Download today by visiting [salesbook.graco.com](http://salesbook.graco.com)



### Graco University

Graco University is an e-learning module that can be accessed online, anytime, and contains assets that help educate you on Graco products.

This innovative online learning program gives the tools to stay on the leading edge with a variety of resources such as virtual and instructor led courses, online books, live and on-demand video presentations, and much more.

Learn more today at [training.graco.com](http://training.graco.com)



### Graco Gear

Graco Gear is your one-stop shop for branded merchandise and other tools that will help you build customer relationships.

Order shirts, hats, banners, and more whenever you need! You can even add your logo for a small fee. Most orders ship next day.

Start shopping today at [graco.mybigcommerce.com](http://graco.mybigcommerce.com)



Graco mobile equipment kits provide the latest technology from Graco, including the G-Series pumps, solid-state proximity switches, CSP divider valves, and hoses and fittings. Each kit will include all of the components necessary for model-specific customizations.

In order to eliminate system design and streamline the sales process, we have created a quick-to-spec, quick-to-quote and quick-to-sell solution. Scan the QR code below or visit [www.graco.com/offroadselector](http://www.graco.com/offroadselector) to find an automatic lubrication kit for your piece of heavy equipment.



**THIS SELECTOR IDENTIFIES KITS AND THE INSTALLATION MANUAL.**

**EQUIPMENT MANUFACTURER** Manufacturer Not Listed?

Please Select One

**EQUIPMENT TYPE**

Please Select One

**MODEL NUMBER** ⓘ

Please Select One

**SYSTEM MONITORING** ⓘ

Please Select One

**PUMP RESERVOIR SIZE** ⓘ

Please Select One

**PUMP CONTROL TYPE**

Please Select One

Mobile Equipment Kits

# PUMPS

	Page
<b>Graco Buyer's Guidance: Pump Selection</b> . . . . .	9-10
<b>Electric Pumps</b>	
Electric Pump Selection Guide . . . . .	11-12
G-Mini® Compact Pumps . . . . .	13-14
G-Mini®/CSP Valve Kits . . . . .	15
G3® Pumps . . . . .	16-21
G-Series Pump Packages and Accessories . . . . .	22-28
G3® Hammer Pump . . . . .	29-30
G3® Dual-Line Pump . . . . .	31-32
G5™ Pumps . . . . .	33-37
Lube Master® . . . . .	38-41
Miniature Meter-Flo® . . . . .	42-43
Meter-Flo® . . . . .	44-45
Compact Dyna-Star® . . . . .	46-47
GLC™ X Controller and Auto Lube™ App . . . . .	47
Electric Dyna-Star® HP and Dyna-Star HF . . . . .	48-51
Manzel® MBL Box Lubricators . . . . .	52-56
<b>Pneumatic Pumps</b>	
Pneumatic Pump Selection Guide . . . . .	58
LubePro™ . . . . .	59-63
LubriSystem . . . . .	64-65
Modu-Flo® . . . . .	66-70
E-Series . . . . .	71-72
MSA-10 and MSA-100 . . . . .	73-74
Pneumatic Dyna-Star® Fire-Ball® 300 50:1 . . . . .	75-76
<b>Hydraulic Pumps</b>	
Hydraulic Pump Selection Guide . . . . .	77
Modu-Flo® . . . . .	78
Hydraulic Dyna-Star® . . . . .	79-82
<b>Mechanical Pumps</b>	
Mechanical Pump Selection Guide . . . . .	83
Lube Master® Ratchet Drive . . . . .	84-86
Manzel® MBL Box Lubricators . . . . .	87-90
<b>Manual Pumps</b>	
Manual Pump Selection Guide . . . . .	91
PH Pump . . . . .	92-93
LubriSystem . . . . .	94



When determining the right Graco pump for your application, please consider the following factors:

## 1. What POWER is available?

Graco has pump options for:

- Electric
- Pneumatic
- Hydraulic
- Mechanical
- Manually operated



If the customer has multiple power options available, which one would they prefer to use?

## 2. What FLUID is being used as the lubricant?

Is this an oil system or a grease system?

- Several pumps work with both oil and grease, but many are for one or the other.
- **Important:** Graco automatic lubrication equipment is designed for use with oils and greases that are based on mineral oil or synthetic lubricant. If you are working with a different material, please contact the correct Graco division.

## 3. Which type of METERING DEVICE is being used?

Single Line Parallel (SLP) systems require a vent valve to function.

- Injectors and piston distributors (Injecto-Flo) are SLP systems.
- Not all pumps are offered with vent valves.
- Some vent valves are sold separately.
- Some do not offer a vent valve option.

Series Progressive Divider Valve (SPDV) and Single Line Resistive (SLR) systems require a relief valve, but not a vent valve.

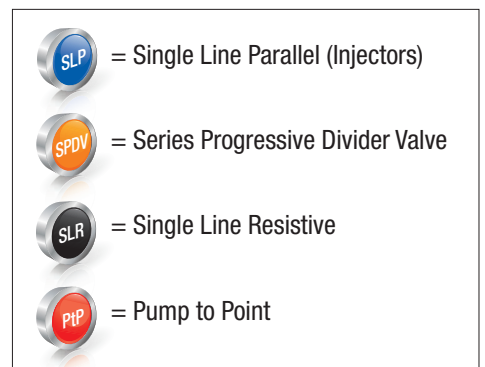

## 4. What FLUID PRESSURE and FLOW RATE are needed to operate the metering system?

Pressure at the pump outlet is affected by the type and size of the metering system, as well as the viscosity and temperature of the lubricant.

- With SPDV and SLR, total flow is simply the sum of all the lube points' flow requirements.
- For Injectors and other SLP systems, extra volume is required because some of it is vented back to the reservoir between lubrication cycles.

*For more information on lubricant metering options, see the Metering Devices section later in this Buyer's Guide.*

## Graco Buyer's Guidance: Pump Selection

---

### 5. What SIZE OF RESERVOIR is required?

System design “best practice” is to deplete the reservoir once a month, if possible.

- This keeps the customer from forgetting that it needs to be refilled regularly.
- Regular reservoir depletion also helps to prevent grease separation.

### 6. Does the customer prefer to have a CONTROLLER INTEGRATED into the pump body?

Integrated controllers are only offered on G-Series pumps:

- G3 SP, Pro and Max
- G5 Pro
- G-Mini Controller
- Electric Grease Jockey (EGJ)

Most G-Series pumps also offer a controller-less version for use with external controllers or a customer's PLC.

- G3 Standard
- G-Mini No Controller

Some pumps are designed to run constantly, without a controller. All other pumps require an external controller, which can be:

- a Graco controller
- a different brand
- a PLC
- or anything that can control the pump's connection to its power source.

*For more information on controller options, see the Controllers section later in this Buyer's Guide.*

### 7. Other factors to consider:

- Does the pump need to send some form of signal output (i.e. alarm, low level, etc.)?
- Does the pump need to log performance data (i.e. DMS or Auto Lube app)?
- Is the pump mounted in a location that would benefit from Auto-Fill Shut Off (AFSO)?
- What are the operating conditions of the application (i.e. weather, heat, vibration, contamination, etc.)?

**Important: Always keep in mind that there could be more than one correct answer.**





- Don't be surprised if you have more than one good option.
- Ultimately the choice may come down to preference; either yours or your customer's.

**Consult with your local Graco Lubrication Account Manager  
for help finding the best solution.**

# Electric Pump Selection Guide

Pump Family	Typical Applications	Voltage	Fluid Type	Maximum Output Pressure psi (bar)	Maximum Output Volume per Minute in <sup>3</sup> (cm <sup>3</sup> )	Reservoir Capacity Options		Metering	Reference Page
						US	Metric – Liters		
 <p><b>G-Mini®</b></p>	<ul style="list-style-type: none"> <li>Energy, Infrastructure and Heavy Equipment</li> <li>In-Plant Manufacturing</li> <li>Vehicle Service</li> </ul>	12 or 24 VDC	Grease up to NLGI #2	4,061 (280)	0.18 (3)	1 or 2 lb	0.5, 1 or 2	SPDV	13-15
 <p><b>G3®</b></p>	<ul style="list-style-type: none"> <li>Energy, Infrastructure and Heavy Equipment</li> <li>In-Plant Manufacturing</li> <li>Vehicle Service</li> </ul>	12 or 24 VDC, 90-240 VAC, 50/60 Hz	Oil – 40 cSt minimum Grease – up to NLGI #2	5,100 (352)	0.25 (4) per element. Up to 3 pump elements.	4, 8, 16, 24 or 32 pint/lb	2, 4, 8, 12 or 16	SPDV or SLP	16-28
 <p><b>G3® Hammer Pumps</b></p>	<ul style="list-style-type: none"> <li>Hydraulic breakers/hammers</li> </ul>	18-30 VDC; 2.5A current, 60W, inrush/locked rotor 6A	Chisel paste, NLGI #000 to #2 greases	5,100 (352)	0.25 (4) per element	8 or 16 lb	4 or 8	SPDV or SLP	29-30
 <p><b>G3® Dual-Line</b></p>	<ul style="list-style-type: none"> <li>Construction equipment</li> <li>Mining equipment</li> <li>Agricultural equipment</li> </ul>	18-30 VDC	NLGI #000 to #2 greases	3,500 (241)	0.25 (4) per element. Up to 3 pump elements.	8 or 16 lb	4 or 8	SPDV or SLP	31-32
 <p><b>G5™</b></p>	<ul style="list-style-type: none"> <li>Quintuplex frac pumps</li> <li>Pumpjacks</li> <li>Other pump-to-point applications</li> </ul>	24 VDC	Packing lube	4,250 psi (293)	0.155 (2.54) per element	8 or 16 lb	4 or 8	PIP	33-37
 <p><b>Lube Master®</b></p>	<ul style="list-style-type: none"> <li>In-Plant Manufacturing</li> </ul>	115/230 VAC, 1 phase or 230/460 VAC, 3 phase 60 Hz	Oil/grease up to NLGI #2	5,000 (345)	8.6 (143)	Oil – 12 or 20 pint Grease** – 6 or 12 lb	Oil – 5.5 or 9 Grease – 3 or 6	SPDV	38-41

\*\*See page 69 for note on legacy Trabon grease reservoir volumes and metric conversions.

 = Single Line Parallel (Injectors)
  = Series Progressive Divider Valve
  = Single Line Resistive
  = Pump to Point

# Electric Pump Selection Guide

Pump Family	Typical Applications	Voltage	Fluid Type	Maximum Output Pressure psi (bar)	Maximum Output Volume per Minute in <sup>3</sup> (cm <sup>3</sup> )	Reservoir Capacity Options		Metering	Reference Page
						US	Metric - Liters		
 <b>Miniature Meter-Flo®</b>	<ul style="list-style-type: none"> <li>In-Plant Manufacturing</li> </ul>	115 VAC, 60 Hz, 1 phase or 230 VAC, 50/60 Hz, 3 phase	Oil – 160 to 15,000 SUS	2,000 (138)	14 (229)	1.5, 3 or 5 gallon (12, 24 or 40 pint)	5.7, 11 or 19	SPDV or SLR	42-43
 <b>Meter-Flo®</b>	<ul style="list-style-type: none"> <li>In-Plant Manufacturing</li> </ul>	Motor sold separately	Oil – 300 to 3,000 SUS	1,500 (103)	245 (4,015)	N/A	N/A	SPDV	44-45
 <b>Electric Grease Jockey®</b>	<ul style="list-style-type: none"> <li>Vehicle Service</li> </ul>	12 or 24 VDC	Grease up to NLGI #2	2,000 (352)	0.5 (8) per element. Up to 3 pump elements.	4 lb	2	SLP	197-199
 <b>Compact Dyna-Star®</b>	<ul style="list-style-type: none"> <li>Energy, Infrastructure and Heavy Equipment</li> <li>In-Plant Manufacturing</li> <li>Vehicle Service</li> </ul>	24 VDC 90-240 VAC, 1 phase, 50/60 Hz*	Oil/grease up to NLGI #2	3,500 (241)	4.5 (74)	24, 48 or 60 lb reservoir or 35 lb pail option	12, 20 or 30 L reservoir or 20 L pail option	SPDV or SLP	46-47
 <b>Electric Dyna-Star®</b>	<ul style="list-style-type: none"> <li>Energy, Infrastructure and Heavy Equipment</li> <li>In-Plant Manufacturing</li> </ul>	24 VDC 90-240 VAC, 1 phase, 50/60 Hz*	Oil/grease up to NLGI #2	5,000 (344)	35 (574) adjustable	60 or 90 lb reservoir	30 or 45 L reservoir	SPDV or SLP	48-51
						or standard barrel length options			
 <b>Manzel® MBL</b>	<ul style="list-style-type: none"> <li>In-Plant Manufacturing</li> </ul>	115/230 VAC, 1 phase or 230/460 VAC, 3 phase, 60 Hz	Oil – 80 to 5,000 SUS	7,500 (517)	2.7 (44) per element, adjustable. Up to 24 pump elements.	4, 6, 8, 12, 16, 24, 32 or 40 pint	1.9, 2.8, 3.8, 5.7, 7.6, 11, 15 or 19	SPDV or PtP	52-56

\*CDS and EDS pumps require converter box 77X524 for AC applications.



= Single Line Parallel (Injectors)



= Series Progressive Divider Valve



= Single Line Resistive



= Pump to Point

## Small size. Big value. Huge impact.

Make the most of your space, budget and machines. The new full-featured G-Mini offers reliable lubrication in a small footprint to fit more types of machines. Use it to simplify everyday maintenance, extend life cycles and optimize uptime. It's rugged and tough, perfect for handling the 24/7 rigors of any job, big or small. Best of all, it comes with a modest price tag – boosting your productivity and profitability.

### Follower Plate and Stir Paddle

Available in 0.5 liter and 1 liter reservoirs.

### Patent-Pending Heater Option

Built-in heater option automatically turns on at 23°F (-5°C), allowing NLGI #2 grease to pump down to -40°F (-40°C).

### M12 Input

M12 cycle or proximity switch input standard on all pumps with a controller.

### Power and Low Level Options

CPC or DIN-style connectors make for easy, no hassle installations.

### Multiple Reservoir Options

0.5 liter, 1 liter and 2 liter grease capacity.

### Up to Two Pump Elements

0.18 in<sup>3</sup>/min (3 cm<sup>3</sup>/min)  
4,061 psi (280 bar)

### Optional Controller

**No Controller:** Pair with either an external controller or a PLC.

**Controller:** Easy-to-program controller can be utilized for both time-based and cycle-based systems and provides low-level alert and alarm.

### Rugged Construction

Designed to withstand the harshest of environments; IP69K rated.



### Typical Applications

- Wind energy
- Industrial
- Off-road mobile equipment
- On-road mobile equipment

### Technical Specifications

Maximum working pressure	4,061 psi (280 bar)
Fluids handled	Grease NLGI #000 to #2, Oils 40 cSt and up
System	Pump to point or series progressive
Power	12 VDC, 24 VDC or 100-240 VAC
Operating temperature	-40°F to 158°F (-40°C to 70°C)
Reservoir size	0.5, 1 or 2 liter
Pump element output	0.18 in <sup>3</sup> (3 cm) per minute
Pump elements	Up to 2
Pump outlet thread	1/4-18 NPSF female, mates with 1/4-18 NPT male fittings
Certifications/Ratings	CE, ETL*, IP69K *Conforms to UL 73, certified to CSA 22.2 No. 68-09
Instruction Manual	3A6714

## Ordering Information

### G-Mini Grease Pumps

Controller Option	Voltage	With Follower Plate		With Follower Plate and Heater	Without Follower Plate	
		0.5 L	1 L	1 L	1 L	2 L
No Controller	12V CPC	–	25R802	–	25R812	25R832
	24V CPC	25R807	25R800	–	25R811	25R831
	24V DIN	–	25R820	–	25R815	25R835
	AC DIN	2000643	2000645	–	2000648	2000650
Controller	12V CPC	25R810	25R803	25R806	25R814	25R834
	24V CPC	25R808	25R801	25R804	25R813	25R833
	24V DIN	–	25R821	25R824	25R817	25R837
	AC DIN	2000644	2000646	2000647	2000649	2000651

### G-Mini Oil Pumps

Controller Option	Voltage	1 L	2 L
No Controller	24V DIN	2000634	2000638
	AC DIN	2000635	2000639
Controller	24V DIN	2000636	2000640
	AC DIN	2000637	2000641

### Accessories

Part Number	Description
127783*	2-wire CPC power cable, 15 ft (4.6 m)
2003467*	5-wire CPC power cable, 15 ft (4.6 m)
16U790*	DIN connector power or low level cable
25C981	12V manual run button (5-wire CPC power cable required)
25C982	24V manual run button (5-wire CPC power cable required)
26C825	Direct mount CSP bracket (allows for drop-in replacement of competition)
26C826	Universal mounting bracket (allows for drop-in replacement of competition)
17L879	Graco CSP solid state proximity switch (DC PNP)
17R703	1 ft proximity switch cable, M12 female straight to M12 male straight cable
124333	16.5 ft proximity switch cable, M12 female straight to M12 male straight
26A910	4,000 PSI pressure relief kit (1/4 NPT to 1/8 NPT reducer bushing, 1/8 NPT tee-fitting, 4,000 PSI pressure relief valve)
26C947	Pump element kit (add a second pump element or replace existing)
24M644	High capacity fill stud with dust cover
121474	Mating coupler for 24M644 fill stud
247886	Manual fill pump – fits 5 gallon or 35 lb pail, includes 121474 (requires 24M644)

\*G-Mini pumps do not come with power cables. Power cables needed for installation.

See the G-Series Pump Accessories section (pages 22-28) for additional G-Mini accessories.



25R802



25R803

## G-Mini/CSP Valve Kits

Each kit includes a pump assembly with mounting bracket, pressure relief valve and outlet hose all pre-assembled to the pump. These kits allow users to quickly build a simple automatic grease system for many small applications. All pumps below include a controller and utilize DIN connections for their power cables.

### Also included:

- G-Mini power cord
- CSP valve
- CSP outlet fittings for 6 mm OD tubing
- 6 mm x 1/8 in NPT end point fittings
- Elbow fitting for the CSP inlet
- 6, 8 and 10 outlet kits include 82 ft (25 m) of 6 mm OD tubing
- 12, 14 and 16 outlet kits include 164 ft (50 m) of 6 mm OD tubing

*Image Coming Soon*

## Ordering Information

### 24 VDC Packages

Kit Part Number	Number of Outlets	24VDC Pump Kit Part Number	CSP Valve Part Number	Outlet Fitting Quantity
2000534	6	2000047	24Z486	6
2000535	8		24Z487	8
2000536	10		24Z488	10
2000537	12		24Z489	12
2000538	14		24Z490	14
2000539	16		24Z491	16

### 115/230 VAC Packages

Kit Part Number	Number of Outlets	AC Pump Kit Part Number	CSP Valve Part Number	Outlet Fitting Quantity
2004439	6	2004436	24Z486	6
2004441	8		24Z487	8
2004443	10		24Z488	10
2004445	12		24Z489	12
2004446	14		24Z490	14
2004447	16		24Z491	16

## Versatile Design Helps Solve Today's Lubrication Challenges

Temperature changes, changing grease types and challenging installation requirements are no problem for the G3 electric lubrication pump. With its flexible design, including five reservoir sizes, three controller options, three power types and an adjustable pump element, the G3 is a rugged, cost-effective pump designed to serve multiple markets and applications.

### Reservoir Types

Stirring paddle with wiper arm to keep material from separating. Follower plate available for extreme angle installations. Spin-off lid option allows easy grease removal for servicing. Auto-Fill Shutoff (AFSO) option simplifies remote filling. Oil reservoirs include vented fill cap and strainer.

### Cycle Switch Input

Count cycles of a series progressive divider valve such as MSP, CSP and others.

### Power Choices

Connect to DC (12 or 24V) and AC (90-240V) power sources with CPC or DIN-style connectors for easy, no hassle installations.

### Machine Count Input

Machine count input to manage equipment with unpredictable lubrication requirements.

### Controller Options

Choose from Standard, Pro and Max controller options – buy only what you need for your application.



### Multiple Reservoir Sizes

Choice of 2, 4, 8, 12 or 16 liter U.V. resistant, high-impact reservoirs for oil and grease to meet the needs of your equipment.

### Three Pump Elements

G3 comes standard with one adjustable pump element installed – add up to two more for higher output on large projects.

### Versatile Pressure Sensor Input

Compatible with analog pressure transducers. Also works with PNP, NPN and dry contact pressure switches.

### Vent Valve Output

Combine Max controller with a vent valve for injector-based systems.

### Typical Applications

- Off-road mobile equipment
- On-road mobile equipment
- In-plant machine and conveyor lubrication
- Wind energy

### Typical Fluids

- Oil
- Grease up to NLGI #2

### Technical Specifications

Maximum working pressure	5,100 psi (352 bar)
Fluids handled	Grease NLGI #000 to #2, Oils 40 cSt and up
Power	12 VDC, 24 VDC or 100-240 VAC
Operating temperature	-40 to 158° F (-40 to 70° C) depending on lubricant used
Reservoir size	2, 4, 8, 12 or 16 liter
Pump element output	0.12 in <sup>3</sup> , 0.18 in <sup>3</sup> or 0.25 in <sup>3</sup> (2 cm <sup>3</sup> , 3 cm <sup>3</sup> or 4 cm <sup>3</sup> ) per minute
Pump elements	Up to 3
Pump outlet thread	1/4-18 NPSF female, mates with 1/4-18 NPT male fittings
Certifications/Ratings	CE, ETL*, IP69K *Conforms to UL 73, certified to CSA 22.2 No. 68-09
Instruction Manuals	Standard – 332291 / Pro – 332298 / Max – 3A9511

## G3 Standard, Pro and Max Gen 2

Choose the level of control you need for your series progressive or injector based applications.

### G3 Standard

- No internal controller – use with separate or existing machine control for a low cost solution
- Capable of sending a low level signal to your external controller or PLC



### G3 Pro

- Built-in controller with selectable pump on/pump off timer
- Low level indicator provides low warning and shut-down alarm
- Manual run initiates lube cycle on-demand (remote option also available)
- Password protection safeguards settings
- Pre-lube function can initiate lube cycle on start-up



#### *Auto-Fill Shut Off (AFSO)*

- Available on G3 Standard, Pro and Max
- Eliminates over- or under-filling
- Completely fill the reservoir while avoiding costly spills
- Does not require power to operate



### G3 Max Gen 2

- Built-in controller with with option of ending on time, cycle or pressure
- Low level indicator provides low warning and shut-down alarm
- Manual run initiates lube cycle on-demand (remote option also available)
- Password protection safeguards
- Pre-lube function can initiate lube cycle on start-up
- Machine count input – ideally suited for inconsistently used equipment
- Fault indication to external alarms



## Ordering Information



### G3 Standard

Comes standard with no controller for use with separate or existing machine control for a low cost solution. Some models capable of sending a low level signal to your external controller or PLC.

Application	Voltage	Reservoir Size					Wiper Arm	Follower Plate	Low Level Switch Connection	Auto-Fill Shut Off	Power Connection
		2 liter	4 liter	8 liter	12 liter	16 liter					
Grease	12 VDC	96G000	96G038	96G039	–	–	•		–		CPC
		96G003	96G044	96G045	–	–	•		M12 female		CPC
		–	96G331	96G332	–	–	•		5-wire CPC		5-wire CPC
	24 VDC	96G001	96G040	96G041	96G171	96G172	•		–		CPC
		96G005	96G048	96G049	96G199	96G220	•		M12 female		CPC
		96G239	96G238	96G198	–	–	•		5-wire CPC		5-wire CPC
		–	–	96G217	–	–		•	5-wire CPC	•	5-wire CPC
		96G006	96G053	96G192	–	–		•	M12 female		CPC
		96G182	96G184	96G189	96G240	96G241	•		DIN		DIN
		96G243	96G204	96G205	–	–		•	DIN		DIN
		–	96G210	96G213	–	–		•	DIN	•	DIN
	100-240 VAC	96G002	96G042	96G043	–	–	•		–		DIN
		96G007	96G055	96G056	96G057	96G058	•		M12 female		DIN
		–	–	–	–	96G237	•		M12 female	•	DIN
		96G008	96G062	–	–	–		•	M12 female		DIN
		–	–	96G207	–	–		•	M12 female	•	DIN
		–	96G202	–	–	–	•		DIN		DIN
		96G320	96G321	96G322	–	–		•	DIN		DIN
Oil	24 VDC	96G050	–	96G052	–	96G258			M12 female		CPC
	100-240 VAC	96G059	96G060	96G061	–	96G291			M12 female		DIN



### G3 Pro

Built-in controller with selectable pump on/pump off timer comes with local manual run and password protection with pre-lube function to initiate lube cycle on start-up. Optional low level sensing available as well as remote manual run.

Application	Voltage	Reservoir Size					M12 Connection for Remote*	Wiper Arm	Follower Plate	Low Level	Power Connection
		2 liter	4 liter	8 liter	12 liter	16 liter					
Grease	12 VDC	96G027	96G135	96G136	–	–		•			CPC
		96G033	96G147	96G148	–	–		•		•	5 Wire CPC**
	24 VDC	96G028	96G137	96G138	–	–		•			CPC
		96G011	96G068	96G069	–	–	•	•		•	CPC
		96G012	96G073	–	–	–	•		•	•	CPC
		96G034	96G149	96G150	96G163	96G167		•		•	5 Wire CPC**
		–	96G196	–	–	–		•			DIN
	–	–	96G194	–	–			•	•	•	5 Wire CPC**
	90-240 VAC	96G029	96G139	96G140	–	–		•			DIN
		96G013	96G075	96G076	96G077	96G078		•		•	DIN
96G014		96G082	–	–	–			•	•	DIN	
Oil	24 VDC	96G070	96G071	96G072	–	–	•			•	CPC
	90-240 VAC	96G079	96G080	96G081	–	–				•	DIN

\*G3 Pro pumps with the M12 connection for Remote Manual Run/Monitoring Light use the kit with the connecting cable to provide external low level indication. Choose part number 571032 for 12 VDC pumps or 571033 for 24 VDC and AC pumps.

\*\*G3 Pro pumps with the 5 Wire CPC power connection are compatible with a Remote Manual Run/Monitoring Light Device to provide external low level indication. Choose part number 571030 for 12 VDC pumps or 571031 for 24 VDC pumps.

Ordering Information



**G3 Max Gen 2**

Gain peace of mind with the pump system that makes it easy for you to know it is working. The G3 Max Gen 2 pumps feature an intuitive LCD screen with backlight. The LCD simplifies programming by displaying a menu, similar to the GLC X and GLC 4400 controllers. Bright LED status lights on the keypad communicate the pump state from a distance, and at a wide angle. Alarm screens includes troubleshooting tips, and a QR code displays on each alarm screen to provide access to Training-On-Demand via Graco's online "G3 Support" Education Center. Optional cellular connectivity provides access to real-time feedback of pump fleet using intuitive Graco Trace™ website.

Ordering the Gen 2 pumps has been streamlined by including all features on all bases. Part number selection is now as simple as choosing the voltage and power connector, and then selecting the reservoir.

Features of Max pumps with DIN power connectors:

- Include DIN Alarm Relay Output, a dry contact relay which opens or closes when a fault is detected. This relay acts as a switch but supplies no power. It requires external power to energize the circuit when closed. If not connected, use part number 24P731 to cover the DIN connector and maintain IP69K rating.
- Include M12 output for illuminated remote manual run buttons. Kit 571033 (sold separately) includes M12 cable and is compatible with both 24V DIN and AC pumps.

Features of new CPC-7 power connection:

- The new CPC-7 power connector utilizes the same CPC connector as previous G-Series pumps; now all 7 positions are populated with input and output functions.
- Connections for tri-color remote manual run and LED push-button in CPC; similar to CPC-5 on the EGJ and G-Mini Controller pumps
- Two alarm output signal wires: one for low level and one for system alarm (requires cable 2001714, sold separately).
- Pumps ship with a 2-wire power cable. For compatibility with illuminated remote manual run buttons 571030 (12V) and 571031 (24V), order 5-wire power cable 2003467 (15 ft/4.6 m), 2003896 (30 ft/9.1m), or 7-wire cable 2001714 (15 ft/4.6 m).

Features of all G3 Max Gen 2 pumps:

- Compatible with Single Line Parallel or Series Progressive applications.
- Pressure sensor input can connect to analog pressure transducer, or normally open pressure switch.
- Include inputs for Machine Count and one Cycle Count.
- Vent Valve output designed for Normally Open vent valves to ensure complete venting of parallel systems.
- Vent Valve output can be re-purposed to control an air solenoid for spray applications.

		Reservoir Options	Pump	2L	4L	8L	12L	16L
Application	Grease	Grease Reservoir with Low Level Paddle	12 VDC CPC-7	96G543	96G547	96G551	96G555	–
			24 VDC CPC-7	96G544	96G548	96G552	96G556	96G560
			24 VDC DIN	96G545	96G549	96G553	96G557	–
			90-240 VAC DIN	96G546	96G550	96G554	96G558	96G562
		With Spin-Off Lid	90-240 VAC DIN	–	–	96G634	–	–
		Grease Reservoir with Follower Plate and LL Paddle	24 VDC CPC-7	96G564	96G568	96G572	–	–
			24 VDC DIN	96G565	96G569	96G573	–	–
			90-240 VAC DIN	96G566	96G570	96G574	–	–
		Grease Reservoir with Follower Plate, AFSO and LL paddle	24 VDC CPC-7	–	–	96G580	–	–
			24 VDC DIN	–	–	96G581	–	–
	90-240 VAC DIN		–	–	96G582	–	–	
	Oil	Oil Reservoir with Low Level Switch	24 VDC DIN	96G591	96G593	96G595	–	96G599
			90-240 VAC DIN	96G592	96G594	96G596	–	96G600

**Pumps with Cellular Connectivity**

LTE-m mobile data connects to Graco Trace™ cloud website for remote access to status of your pumps from anywhere you can connect to the web; on your phone, tablet or PC. The analog level sensor communicates lubricant reservoir status to the cloud. Graco Trace lets you to program the pump remotely, reset alerts and alarms, and can send optional SMS and email messages when alerts or alarms occur.

		Reservoir Options	Pump	4L	8L
Application	Grease	Grease Reservoir with Follower Plate and Analog Level Sensor	12 VDC CPC-7	96G601	96G605
			24 VDC CPC-7	96G602	96G606
			24 VDC DIN	96G603	96G607
			90-240 VAC DIN	96G604	96G608
		Grease Reservoir with Follower Plate, AFSO Valve and Analog Level Sensor	12 VDC CPC-7	–	96G609
			24 VDC CPC-7	–	96G610
	Oil	Oil Reservoir with Low Level Switch	24 VDC DIN	96G613	96G615
			90-240 VAC DIN	96G614	96G616
			24 VDC DIN	–	96G611
			90-240 VAC DIN	–	96G612

Scan to watch a demo of Graco Trace™



## Ordering Information



### G3 Pumps with Auto-Fill Shut Off

Versatile line of G3 Pumps (Standard, Pro, and Max) offered with a factory installed Auto-Fill Shut Off (AFSO). The AFSO feature automatically shuts off lubricant flow from a fill pump to the G3 reservoir once the G3 reservoir is full. The G3 AFSO is based on the same design concept as the Auto-Fill Shut Off offered in conjunction with the robust Electric Dyna-Star product line. Eliminate the need to climb up on equipment to refill an empty reservoir by adding Remote Fill Manifold 77X542 to your system at ground level.

	Voltage	G3 Model	Reservoir Size		Wiper Arm	Low Level	Power Connection
			4 liter	8 liter			
Application Grease	24 VDC	Standard	96G210	96G213	•	• DIN	DIN
			–	96G217	•	•	5-wire CPC*
		Pro	–	96G214	•	•	5-wire CPC*
		Max	–	96G580	•	•	7-wire CPC*
	90-240 VAC	Standard	–	96G207	•	•	DIN
		Pro	–	96G208	•	•	DIN
Max		–	96G582	•	•	DIN	

\*Low level in CPC: G3 Pro and Max pumps are compatible with a Remote Manual Run/Monitoring Light Device to provide external fault indication. Choose part number 571030 for 12 VDC pumps or 571031 for 24 VDC pumps.

### G3 Auto-Fill Shut Off Field Conversion Kits

	Part Number	Description
	571286	G3 AFSO 4L field conversion kit
	571287	G3 AFSO 8L field conversion kit
	571288	G3 AFSO 12L field conversion kit
	571289	G3 AFSO 16L field conversion kit

Ordering Information

**G-Series Reservoir Upsize and Conversion Options**

G3 and Electric Grease Jockey pumps all consist of a base and a reservoir. The bases are all designed for 2 L reservoirs, so to convert to a larger a reservoir, a 2 L to 4 L adapter is required.

Size	Oil Reservoirs	Grease Reservoirs	
	8 L and larger oil reservoirs simply require one 4 L oil reservoir plus expansion rings (qty.)	Upsize (with Wiper Arm)	Auto-Fill Shut Off*
4 liter	571182	571155	571286
8 liter	571182 (1) + 25C764 (1)	571156	571287
12 liter	571182 (1) + 25C764 (2)	571157	571288
16 liter	571182 (1) + 25C764 (3)	571158	571289

\*AFSO reservoir kits do not include adapter ring. Order p/n 574002 separately when converting from a 2 L reservoir to an AFSSO reservoir.

**G3 Injector Pump Pre-assembled Modules**

Part Number		Description
8 liter	16 liter	
17J999	17N926	G3 Injector Pump Pre-assembled Module: 24V, Max, 5 Pin CPC (alarm, manual run, low level in the CPC), 2 pump elements, union kit, vent valve, pressure switch, pressure gauge.

**G3 Pump Elements**

	Part Number	Description
	571041	Pump element – same adjustability as the pump included with G3 pumps.
	571041PK	100-pack of replacement pump elements
	24V837	Food and Beverage Upgrade Kit – contains pump element, stainless Zerk fitting, and stainless reservoir plugs.

**G3 Pump Output Union Kits**







Pump element(s) sold separately.

	Part Number		Description
	Three (3) Pumps	Two (2) Pumps – Left and Right	
	571026	571063	For systems without a direct-mount vent valve installed on the first pump outlet.
	24P295	24P296	For systems with a direct-mount vent valve installed on the first pump outlet.

Each G3 includes one pump element when it ships. Add one or two more (p/n 571041) and the appropriate union kit if needed for your application.

## Ordering Information



### G-Series Pressure Relief Valve (PRV) Options

	Part Number		Description
	Outlet Thread		
	NPT	BSPP	
	571028	571071	Adjustable return-to-reservoir pressure relief kit – 500 to 3,500 psi (35 to 241 bar).
	556420*	–	Male run tee – 1/4 NPT, use with 571028 kit to increase pressure limit to 5,000 psi.*
	26C030*	26C176*	Pressure relief to atmosphere kit – 5,000 psi (345 bar).*
	26A910	–	Pressure relief to atmosphere kit – 4,000 psi (276 bar).
	16V999	–	Pressure relief to atmosphere valve – 1/8 in NPT male, 5,000 psi (345 bar).*
	115122	–	Pressure relief to atmosphere valve – 1/8 in NPT male, 4,000 psi (276 bar).
	571058	571070	Pressure relief-to-atmosphere kit – requires one of the following six pressure relief valves:
		563156	Pressure relief valve – 750 psi (52 bar)
		563157	Pressure relief valve – 1,000 psi (69 bar)
		563158	Pressure relief valve – 1,500 psi (103 bar)
		563159	Pressure relief valve – 2,000 psi (138 bar)
		563160	Pressure relief valve – 2,500 psi (172 bar)
		563161	Pressure relief valve – 3,000 psi (207 bar)
	25U706		<b>G-Series Gauge And Relief Valve Adapter Kit</b> – includes 5,000 psi/350 bar gauge (2007096), street cross fitting (133643) and 1/4 NPT x NPSM swivel fitting (156823). Allows connection of gauge, relief valve and outlet fitting to pump outlet. NPSM swivel fitting installs in the G-Series pump outlet for easy clocking of the complete assembly. Relief valve sold separately – choose from one of the options above.
	2008155		<b>G-Series Gauge and Return-to-Reservoir Adjustable Pressure Relieve Valve Kit</b> – includes all of the parts in kit 25U706, plus adjustable PRV with elbows and tubing to plumb back to the reservoir of a G3 or G-Mini pump.

\*Not for use with G-Mini pumps.



Ordering Information

G-Series Remote Manual Run/Monitoring Lights



	Part Number		M12 Cable Included?
	12 VDC	24 VDC*	
	571030	571031	No. Use with CPC-5 or 2CPC-7 power cables.
	571032	571033	Yes. 16.5 ft (5 m). Use with pumps that have M12 input for manual run.

\*24 VDC is also used with AC powered G-Series pumps.

G3 Mounting Bracket Options



	Part Number	Description
	125910	G3 pump mounting L-bracket
	571159	G3 reservoir support bracket for mobile installations – secures 12 and 16 liter reservoirs.
	132187	G-Series isolation kit (vibration damper)

G3 Protective Front Cover Kits

	Part Number	Description
	571036	Black
	571255	Clear
	24Z962	Clear with cutouts for Reset and Manual Run buttons







Grease Pressure Gauges

Stainless steel case, liquid filled (glycerin), 0-5,000 PSI (0-350 bar).

	Part Number	Thread	Mount	Suggested Use
	115523	1/4 NPT brass	Back	Vent valve gauge port
	2007096		Bottom	Tee into pump outlet with part number 556420



## Ordering Information

### G-Series Reservoir Filling Accessories

	Part Number	Description
	24M644	High capacity fill coupler with quick disconnect and dust cover
	77X542	Remote-fill manifold with vent – for use with reservoirs that have AFSSO.
	121474	Female coupler – mates to 24M644 fill stud and 77X542 remote fill manifold.
	2006967	Cartridge filler pump kit – for use with grease cartridges. Kit includes manual pump 2006597 and G3 adapter fitting 2000201.
	2000201	Manual hand pump adaptor – for use with 2006597 fill pump to protect threads in pump base.
	571064	Cold temperature fill relief kit – prevents over-pressurizing when filling in cold temperatures.

### Refill Pump Kits



Each kit includes 121474 coupler.

	Part Number	Description
	247886	Manual hand pump for 35 lb pail
	2002295	LD Series 35 lb fill pump kit
	2002296	LD Series 120 lb fill pump kit
	26A320	Mini Fire-Ball 400 lb fill pump kit

» Ordering Information



**G3 Pump Enclosure Kits**

Ideal for fracturing equipment lubrication, these kits contain a G3 pump, valve assemblies, durable enclosure and mounting assemblies.

	Part Number	Description
	132090	Triplex, 12V, G3 Pro
	132091	Triplex, 24V, G3 Pro
	132154	Triplex, 24V, G3 Standard
	132092	Quintuplex, 12V, G3 Pro
	132093	Quintuplex, 24V, G3 Pro
	132155	Quintuplex, 24V, G3 Standard
	132089	Standalone enclosure with G3/MSP mounting panel
	132188	G3/MSP mounting panel
	132163	Isolator kit



## Ordering Information

### Machine Count Sensors

	Part Number	Description
	17J939	G3 machine count inductive sensor – 12-24 VDC. NPN normally open, M12 male, 5 mm sensing distance.
	557781	“Microswitch” dry contact limit switch – AC/DC. Can be wired N.O. or N.C. Use with cable 124300 and cord grip 260067.

### Pressure Switches



Use to read pressure in an injector-based system. After injectors dispense, controller or G3 Max will trigger pump shut down and vent.

	Part Number	Voltage and Switch Type	Pressure Setting Range	Porting	Electrical Connector	Notes
	24N181	AC/DC, Dry Contact	580 to 5,800 psi (40 to 400 bar)	1/4 NPT female	DIN connector (included)	Designed specifically for grease. Includes DIN connector – just add 124300 to connect to G3 Max.
	24K414	10-32 VDC, PNP	Set: 290 to 5,800 PSI (20 to 400 bar) Reset: 175 to 5,685 PSI (12 to 392 bar)	1/4 NPT male	M12 male	Dual pressure setting adjustments. M12 connection makes it easy to wire to a G3 Max.

For more pressure switch options and more details, see page 204.

### Solid State Proximity Switches

Use with Series Progressive Divider Valves to count cycles.

	Part Number	Voltage and Switch Type	Divider Valve	Thread	Electrical Connector
	17L983	10-36 VDC, PNP	MSP and MHH	7/16-20	M12 male
	17L879		CSP	M11	

### Cables for Solid State Proximity Switches

Use with a G3 Max or G3 SP when connecting directly to the pump, when LED cycle indication is required.







Part Number	Proximity Switch Connection	2nd Connection	Length	Notes
25M602	M12 female, straight	Flying leads	16.5 ft (5 m)	PNP switch with NPN LED – requires 124594
25M603		M12 male, straight		PNP switch with NPN LED

For more proximity switch and cable options, and more details, see Proximity Switches section on pages 161-162.

Ordering Information

**Other Wiring Accessories for G-Series Pumps**

Use with a G3 Max or G-Mini when connecting directly to the pump, when LED cycle indication is not required.

	Part Number	1st Connection	2nd Connection	Length	Notes
	126331	M12 female, straight	Flying leads	16.5 ft (5 m)	Requires 124594 when used with G3 Max or G-Mini
	124300	M12 male, straight	Flying leads	16.5 ft (5 m)	Accessory cable – add 124301 when connecting to an M12 sensor.
	124333	M12 female, straight	M12 male, straight	16.5 ft (5 m)	Accessory cable
	124301	M12 female, straight	–	–	Connector for 6-8 mm cable
	124594	M12 male, straight	–	–	Connector for 6-8 mm cable
	124640	DIN female	Flying leads	6.6 ft (2 m)	Output cable for DIN alarm relay (G3 Max)
	127123	DIN female	–	–	Field wireable DIN connector
<i>Image Coming Soon</i>	24P731	DIN power/ alarm cover	–	–	With gasket and screw, IP69K rated

## Ordering Information

### Direct-Mount Vent Valves for G3 Pumps

G3 pump vent valve kits include adjustable pressure relief, 500-3,500 psi (35-241 bar), and mount directly to a G3 pump.

### Normally-Open Vent Valves for Use with G3 Max Pumps

	Voltage	Part Number		Power Cable
		NPT	BSPP	
	12 VDC	2008943	2008945	Included
	24 VDC	2008944	2008946	Included
	AC pumps	2008944	2008946	Included

G3 Max AC pumps are 24 VDC internally, so they use 24 VDC accessories, including the vent valve and pressure sensors.

### Normally-Open Vent Valves for Use with G3 Standard Pumps



	Voltage	Part Number		Power Cable
		NPT	BSPP	
	12 VDC	24M478	24M481	24N402
	24 VDC	24M479	24M482	24N402
	115 VAC	24M480	24M483	16U790*
	230 VAC	24N182	24M484	16U790*

\*24N351 is alternative patch cable which connects directly to DIN power connection.

### Low Pressure Vent Valve for Use with G3 Pumps

Part Number	Description
2001401	Similar to 24M483 (above) but with a lower adjustment range, this vent valve is intended for use with piston distributors such as Injecto-Flo. Includes adjustable pressure relief, 200-750 psi (14-52 bar), factory set to 200 psi (14 bar). BSPP outlet thread. Normally Open solenoid, for use with G3 Standard pumps. 115 VAC with DIN connector, requires power cable 16U790 or 24N351.

### Vent Valves Accessories for G3 Standard Systems

	Part Number	Description
	24N402	Vent valve power cable – normally open, 12 or 24 VDC valve, Deutsch connector, 6 feet
	16U790	Vent valve power cable – normally open, 115 or 230 VAC valve, DIN connector, 15 feet
	24N351	Save installation time and money without the need for additional cabling. Patch cable connects vent valves with DIN connection directly to the DIN Pump Power connector.

## Ideal for Hydraulic Breaker/Hammer Lubrication

Extend the life of your hydraulic hammer/breaker tools and provide a breakthrough for your budget. The new G3 Hammer Pump offers convenient top fill access, enabling chisel paste to be quickly added to the reservoir to avoid halting operations. Designed for harsh, high vibration environments, the G3 Hammer Pump ideally handles high shock hammer/breaker applications with ease.

### Spin-Off Reservoir Cover

Quickly fill hard to pump grease from the top of the reservoir.

### Robust Cover Design

Reinforced ribs to withstand high vibration and shock applications.



### Multiple Reservoir Options

Available in both 4 and 8 liter capacities.

### Up to Three Pump Elements

0.25 in<sup>3</sup>/min (4 cm<sup>3</sup>/min) per element. 5,100 psi (351.6 bar).

### Power and Low Level Options

CPC or DIN-style connectors make for easy, no hassle installations.

### Versatile Pump Elements

Built to withstand the harshest of greases, such as chisel paste and other greases containing additives.



### Typical Applications

- Hydraulic breakers/hammers
- Carrier or pedestal mounted

### Technical Specifications

	96G278	133789	96G279	133791
Power source	18-30 VDC; 2.5A current, 60W, inrush/locked rotor 6A			
Fluids handled	Chisel Paste, NLGI #000 to #2 Greases			
Operating temperature	-40°F to 158°F (-40°C to 70°C)			
Reservoir size	4 Liter		8 Liter	
Control option	Control pump via external control method			
Pump elements	Ships with one pump element, add up to two additional pump elements			
Output pressure	5,100 psi (35.1 MPa, 351.6 bar)			
Pump output	0.25 in <sup>3</sup> /min (4 cm <sup>3</sup> /min) per pump element			
Pump outlet	1/4-18 NPSF, mates with 1/4-18 NPT male fittings			
Protection grade	IP69K			
Instruction Manual	332291			

# G3® Hammer Pump

## Ordering Information

### G3 24 VDC Hydraulic Breaker/Hammer Chisel Paste Lubrication Pumps

	Part Number	Description
	96G278	4 Liter, 5-Wire CPC Cable
	96G279	8 Liter, 5-Wire CPC Cable
	133789	4 Liter, External Low Level, 2 DIN Cables
	133791	8 Liter, External Low Level, 2 DIN Cables

## Reliable Drop-In Dual-Line or Twin Pump Upgrade

Designed for a seamless pump upgrade or replacement in existing dual-line lubrication systems for yellow iron equipment. Effortlessly upgrade your dual-line or twin pump system while ensuring compatibility with the machine's existing dual-line metering devices.

### Versatile Reservoir Options

Choose from durable 4- or 8-liter U.V. resistant, high-impact reservoirs.

### Proven Components

Field-proven pump elements and motors engineered to excel in the toughest applications.

### Easily Accessible Components

Streamline maintenance and troubleshooting.

### User-Friendly Pump Management

Effortlessly adjust pump parameters using the built-in controller (G3 Max models) or included GLC X® controller (G3 Standard models).

### Universal Mounting Bracket

Easily install into existing dual-line systems.

### Fail-Safe Reversing Valve

Minimize failures with a mechanically controlled reversing valve.



### Typical Applications

- Construction equipment
- Mining equipment
- Agricultural equipment

### Technical Specifications

Power source	18-30 VDC
Fluids handled	NLGI #000 to #2 greases
Operating temperature	14°F to 122°F (-10°C to 50°C)
Reservoir size	4 or 8 liters
Control option	Built-in (G3 Max models), GLC X (G3 Standard models)
Pump elements	Ships with three pump elements if not specified in description
Output pressure	3,500 psi (24.1 MPa, 241 bar)
Pump output	0.25 cu in/min (4 cc/min) per pump element
Valve outlet	(2) 1/4 in NPT female
Protection grade	IP69K
Instruction Manual	3A7830

# G3® Dual-Line Pump

## Ordering Information

### G3 Dual-Line Pumps

	Part Number	Description
	2002240	G3 Max, 24 VDC, 4 liter with Internal Controller, 3 Pump Elements
	2002241	G3 Max, 24 VDC, 8 liter with Internal Controller, 3 Pump Elements
	2002243	G3 Standard, 24 VDC, 4 liter with GLC X Controller, 3 Pump Elements
	2002244	G3 Standard, 24 VDC, 8 liter with GLC X Controller, 3 Pump Elements
	2006886	G3 Max, 24 VDC, 4 liter with Internal Controller, 2 Pump Elements
	2006887	G3 Max, 24 VDC, 8 liter with Internal Controller, 2 Pump Elements
	2002247	G3 Standard, 24 VDC, 4 liter with GLC X Controller, 2 Pump Elements
	2002248	G3 Standard, 24 VDC, 8 liter with GLC X Controller, 2 Pump Elements

### Accessories

Part Number	Description
2002702	3 Pump Element Union Kit with Pressure Relief Valve
2006225	G3 to Dual-Line Conversion Kit – Reversing Valve, Union Kit, Mounting Bracket
2004626	NPT to M10 Fitting
2002258	Reversing Valve Assembly
2004545	Reversing Valve Remote Mounting Kit
2004968	Reversing Valve Rebuild Kit

## Designed for Quintuplex Packing Lube

Greater profit is within reach with Graco G5 pumps. Equipped with five pump elements for more versatile and simpler grease operations, the G5 has been designed specifically for the harsh demands of fracking operations.

### Robust Reservoir

U.V. resistant, high-impact reservoirs to meet the needs of your equipment.

### Auto-Fill Shutoff Option

Completely fill the reservoir while avoiding costly spills with an optional AFSSO.

### Flexible Power Options

Two CPC-style connectors with low level output options make for easy, hassle-free installations.

### Reservoir Wiper Arm

Stirring paddle with wiper arm to keep material from separating.

### Optional Pressure Relief Valves

Install up to five pressure relief valves with the option to vent back into the reservoir.

### Five Pump Elements

G5 comes standard with five adjustable pump elements installed.

### Two Controller Options

Use your existing machine's controller or choose the G5 Pro's built-in controller.

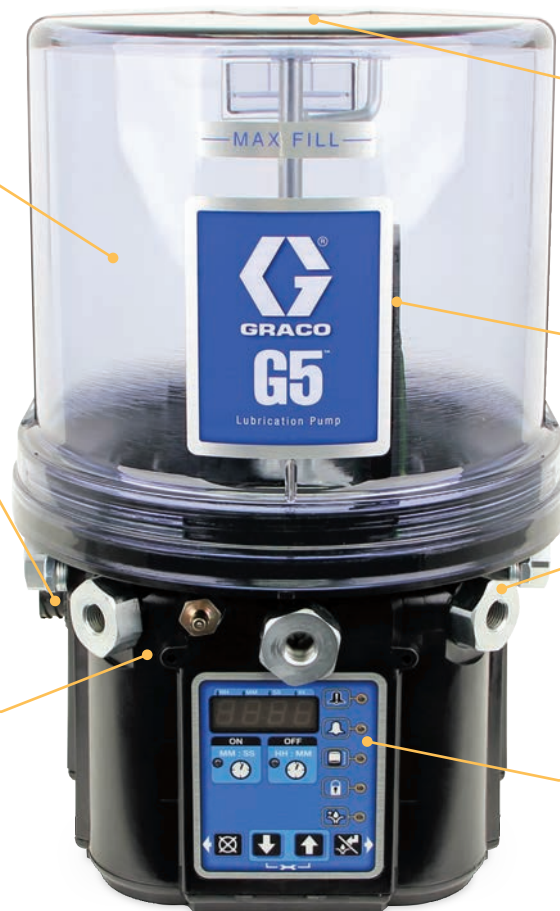

### Typical Applications

- Quintuplex frac pumps
- Pumpjacks
- Other pump-to-point applications

### Typical Fluids

- Packing lube





### Technical Specifications

Maximum working pressure	4,250 psi (293 bar)
Power	24 VDC
Operating temperature	-40°F to 158°F (-40°C to 70°C), depending on lubricant used
Reservoir size	4 and 8 liter (Enclosures fit 4 liter only)
Maximum run time	30 minutes
Control options	Standard (no controller) or Pro (timer)
Adjustable pump output per element per minute*	0.155 in <sup>3</sup> (2.54 cm <sup>3</sup> ) [no shim] 0.104 in <sup>3</sup> (1.70 cm <sup>3</sup> ) [1 shim] 0.055 in <sup>3</sup> (0.90 cm <sup>3</sup> ) [2 shims]
Enclosure dimensions (L x W x H)	Small – 17.75 in x 14.94 in x 13.00 in (45 cm x 38 cm x 33 cm) Large – 22 in x 17 in x 18 in (56 cm x 44 cm x 46 cm)
Certifications/ratings	CE, UKCA
Instruction Manual	Standard – 3A8847 / Pro – 3A8848 / Pro with Enclosure – 3A9275

\*Shims not included with pump element. Please see shim kit under Accessories section.

## Ordering Information

### G5 24 VDC Standard Grease Pumps

	Part Number	Description
	95G102	4 liter, 5-pin CPC
	95G103	4 liter, external low level, 5-pin CPC
	95G109	4 liter, external low level, side vent, no power cord, 5-pin CPC
	95G112	8 liter, 5-pin CPC
	134178	Assembly, 4 liter, external low level, side vent, no power cord, 5-pin CPC, pressure relief valves

Ordering Information

G5 24 VDC Pro Grease Pumps

	Part Number	Description
	95G104	4 liter, low level with controller, 5-pin CPC
	95G106	4 liter, remote manual run, 5-pin CPC
<p><i>Image Coming Soon</i></p>	95G108	4 liter, auto-fill shutoff, 5-pin CPC
<p><i>Image Coming Soon</i></p>	95G110	4 liter, auto-fill shutoff, DIN power, DIN alarm
<p><i>Image Coming Soon</i></p>	95G111	8 liter, auto-fill shutoff, DIN power, DIN alarm
	134179	Assembly, 4 liter, auto-fill shutoff, DIN power, DIN alarm, pressure relief valves, return to reservoir, controller cover
	134180	Assembly, 8 liter, auto-fill shutoff, DIN power, DIN alarm, pressure relief valves, return to reservoir, controller cover

Electric Pumps

## Ordering Information

### G5 24 VDC Grease Pumps with Enclosure

	Part Number	Description
	134410	Assembly – small enclosure, G5 Standard pump, 4 liter, pressure relief valves
	134411	Assembly – small enclosure, G5 Standard pump, 4 liter, pressure relief valves, return to reservoir
	134010	Assembly – small enclosure, G5 Pro pump, 4 liter, pressure relief valves, run lights
	134011	Assembly – large enclosure, G5 Pro pump, 4 liter, auto-fill shutoff, pressure relief valves, run lights

### G5 Pump Enclosure Accessories

Part Number	Description
132095	Enclosure rubber grommet for power or AFSSO
133919	Flying lead AMP connector
133994	Run light kit – green
133995	Run light kit – red
134142	Fluid manifold assembly – small enclosure
134167	Fluid manifold assembly – large enclosure
134169	Small bare enclosure
134170	Large bare enclosure
132163	Enclosure isolator kit

Ordering Information

G5 Pump Accessories

	Part Number	Description
	571041	Pump element
	571041PK	100-pack of replacement pump elements
<i>Image Coming Soon</i>	133960	Return to reservoir kit – includes no pressure relief valves
<i>Image Coming Soon</i>	133958	Return to reservoir kit – includes five pressure relief valves
	133910	Pressure relief valve, 4,000 psi (276 bar)
	133991	Pressure relief valve kit, 4,000 psi (276 bar) – includes five pressure relief valves
<i>Image Coming Soon</i>	571286	Auto-fill shutoff reservoir kit
<i>Image Coming Soon</i>	133457	Pump shim kit – includes five shims
	132187	G5 isolator kit
	127780	G5 pump power cord
	121474	Female coupler for reservoir fill port
	115523	Back mounted 1/4 in NPT pressure gauge, 0-5,000 PSI (0-350 bar)
	2007096	Bottom mounted 1/4 in NPT pressure gauge, 0-5,000 PSI (0-350 bar)
	125910	G5 pump mounting L-bracket
	571159	G5 reservoir support bracket for mobile installations – secures 12 and 16 liter reservoirs.
	571036	Black
	571255	Clear
	24Z962	Clear with cutouts for Reset and Manual Run buttons

## Built for Severe-Duty Environments

The Lube Master is a rugged pump package designed for demanding applications. The adjustable output and anti-friction drive bearings make it both reliable and efficient. Rugged cast aluminum main body and heavy-duty internal components deliver consistent performance in harsh applications. With several reservoir choices and accessories to choose from, the Lube Master pump can be easily customized to meet virtually all application needs.

### Continuous Duty

1/2 hp motors in 1 phase or 3 phase, choose from two different RPMs for each.

### Reservoir Options

For oil or grease, 12 or 20 pint/pound, plastic or metal.

### Low Level Switch Options

Available for both oil and grease reservoirs.

### Drive and Mounting Base

Choose from two gearbox ratios to configure your flowrate range. Choose floor mount or wall mount.

### Adjustable Pump Displacement

Set the pump output with the turn of a wrench.



### Typical Applications

- Cement plants
- Paper processing
- Steel mills
- Other harsh environments

### Typical Fluids

- Oil
- Grease up to NLGI #2

### Technical Specifications

Cycle Rate	1-175 strokes per minute
Output Volume per minute	See chart below
Max Output Pressure	5,000 psi (340 bar)
Material	Plastic or metal, cylindrical
Reservoir Size	Oil – 12 pint, 20 pint / Grease – 12 lb, 20 lb
Motor	115/230 VAC, 230/460 VAC, 60 Hz
Instruction Manual	3A2781

### Theoretical Calculated Discharges of Lube Master

Motor Speed (RPM)	60:1 Gear Ratio		10:1 Gear Ratio	
	Discharge Output in <sup>3</sup> (cm <sup>3</sup> )			
	Minimum	Maximum	Minimum	Maximum
1,140	0.19 (3.11)	0.95 (15.57)	1.14 (18.69)	5.7 (93.42)
1,725	0.28 (4.59)	1.48 (23.44)	1.72 (28.19)	8.62 (141.28)

Ordering Information

**Popular Lube Master Assembly Models**

Pressure Gauge 2007096 is included with every LMxxxx assembly.

**Grease Packages**



Part Number	Reservoir		Base Mounting Configuration	Drive Ratio	Motor – All motors are 1/2 hp, 60 Hz		Low Level Switch	
	Material	Capacity			RPM	Voltage		
LM6334	Plastic	20 pound	Floor	10:1	1,725	230/460 VAC, 3-phase	SPDT, 15 amp	
LM6544				60:1	1,140	115/230 VAC, 1-phase	SPDT, 15 amp	
LM6611			Wall		None		None	
LM7311	Metal	12 pound	Floor	10:1	None		None	
LM7354					1,140	230/460 VAC, 3-phase	SPDT, 15 amp	
LM7534				1,725	230/460 VAC, 3-phase	SPDT, 15 amp		
LM8534			60:1	20 pound	Floor	1,725	230/460 VAC, 3-phase	SPDT, 15 amp
LM8544						1,140	115/230 VAC, 1-phase	SPDT, 15 amp

**Oil Packages**

Part Number	Reservoir		Base Mounting Configuration	Drive Ratio	Motor – All motors are 1/2 hp, 60 Hz		Low Level Switch
	Material	Capacity			RPM	Voltage	
LM2536	Plastic	20 pint	Floor	60:1	1,725	230/460 VAC, 3-phase	SPST, 10 watt
LM4333				10:1	1,725	230/460 VAC, 3-phase	SPDT, 15 amp
LM9511	Metal	Overhead Supply		60:1	None		None
LM9521			1,725		115/230 VAC, 1-phase	None	



**Accessories**

**Pressure Indicators**

	Grease – Aluminum-colored disk, 2,350 PSI (162 bar)	Oil – Yellow-colored disk, 1,450 PSI (100 bar)	Description
	563184	563179	Standard blowout fitting
	563385	563384	High-pressure blowout switch kit*
	563965	563962	Package of 6 blowout disks

\*Each kit requires approximately 3 ft of 1/4 in OD copper tubing, not included.



**Low Level Switches – Grease**

	Part Number	Description
	563322	Standard SPDT, 15 amp switch kit, mounts to top of all grease reservoirs
	564318	High/low level switch kit, for metal grease reservoirs only
	564377	Explosion-proof LL switch for grease reservoirs. (Class I, Group C and D; Class II, Group E, F and G)

Electric Pumps



## Ordering Information

### Low Level Switches – Oil

	12 Pint	20 Pint	Description
	563015	563016	SPST, 10 watt, most popular option
	563316	563317	SPDT, 15 amp, for use with heavy or stringy oils

### Pump Repair Kits

At the heart of all current Lube Master pump packages is pump part number 563380. There are three repair kits for the pump and some of the parts overlap because each kit includes some of the same seals. To completely rebuild the pump, all three kits are required and some extra parts will remain because of this overlap.

	Part Number	Description
	563915	Driveshaft Kit. Includes the driveshaft, cam, bearings and related seals and hardware.
	563921	Seal Kit. Includes seals and small hardware.
	563916	Standard Output Manifold Kit. Includes pump piston and cylinder, output manifold block and related seals and hardware.

### Reservoir Repair Kits

	Part Number	Description
	562902	Polycarbonate tube with u-cup seal for part numbers 562892 (12 pt) and 562896 (12 lb).
	562903	Polycarbonate tube with u-cup seal for part numbers 562893 (20 pt) and 562897 (20 lb).

### Replacement Gear Reducers

Floor Mount and Wall Mount drives use the same gear reducers.

	Part Number	Description
	557160	10:1 Gear Reducer
	557161	60:1 Gear Reducer

Ordering Information

**Lube Master Ordering Menu Code**

Use the Smart Numbering System to order a complete assembly! The six-digit Smart Numbering System can help you order quickly and accurately. Simply follow the diagram for the configuration you want and build your order. Alternatively, use the part numbers at right to order individual components and assemble them in the field.

Code	Former Code	Description	Part Number	LM	Reservoir	Drive	Motor	Low Level
<b>Product Identifier</b>					X	X	X	X
LM	LUB	LM = Lube Master	563380					
Note: When ordering Lube Master bare pump 563380 for use with a grease reservoir, a fill stud is required (part number 557374). Fill stud 557374 is compatible with mating coupler 558906. Order separately.								
<b>Reservoir Options</b>								
1	OPA	12 pt plastic oil reservoir	562892					
2	OPB	20 pt plastic oil reservoir	562893					
4	OMB	20 pt metal oil reservoir	562895					
5	GPA	12 lb plastic grease reservoir	562896					
6	GPB	20 lb plastic grease reservoir	562897					
7	GMA	12 lb metal grease reservoir	562898					
8	GMB	20 lb metal grease reservoir	562899					
9	OHS	Power Prime/Overhead Supply	562908					
<b>Drive Options</b>								
1	DOO	No drive	N/A					
2	DOA	Clutch drive with ratchet arm	563383					
3	DOB	10:1 reduction, floor-mounting base	563388					
4	DOC	10:1 reduction, wall-mounting base	563386					
5	DOD	60:1 reduction, floor-mounting base	563389					
6	DOE	60:1 reduction, wall-mounting base	563387					
Note: Drive Options 3, 4, 5, and 6 each contain all required mounting hardware (mounting plate, coupler, coupler guard, nuts, bolts, and washers).								
<b>Motor Options</b>								
1	MOO	No motor	N/A					
2	MOA	1/2 HP, 115/230 VAC, single phase, 60 Hz, 1,725 rpm	557271					
3	MOB	1/2 HP, 230/460 VAC, 3-phase, 60 Hz, 1,725 rpm	557270					
4	MOC	1/2 HP, 115/230 VAC, single phase, 60 Hz, 1,140 rpm	557272					
5	MOD	1/2 HP, 230/460 VAC, 3-phase, 60 Hz, 1,140 rpm	557273					
<b>Low Level Options</b>								
1	LOO	No level switch	N/A					
2	LOA	12 pt oil, SPDT, 15 amps	563316					
3	LOB	20 pt oil, SPDT, 15 amps	563317					
4	LOC	12 and 20 lb grease, SPDT	563322					
5	LOE	12 pt oil, SPST, 10 watts	563015					
6	LOF	20 pt oil, SPST, 10 watts	563016					
N/A*	N/A	High/low level switch kit (for METAL grease reservoirs only)	564318					
N/A*	LOH	Explosion-proof LL switch for grease reservoirs. (Class I, Group C and D; Class II, Group E, F, and G)	564377					

\*564318 and 564377 are sold separately and field-installed. Choose option "1" and then order either part separately.

<b>Pressure Gauge (included)</b>			
N/A	G1	No gauge	N/A
N/A	G3	Liquid-filled 0-3000 psi gauge	2007096

Note: 2007096 is included with every LMxxxx assembly, but not with the bare pump.

<b>Pressure Indicators (sold separately, but required for safety)</b>			
N/A	POA	Standard Blowout, 1,450 psi (100 bar), Oil	563179
N/A	POB	Standard Blowout, 2,350 psi (162 bar) Grease	563184
N/A	POC	High-Pressure Blowout Switch, 1,450 psi (100 bar), Oil	563384
N/A	POD	High-Pressure Blowout Switch, 2,350 psi (162 bar), Grease	563385

Note: Options POC and POD require approximately 3 feet of 1/4 in OD copper tubing, which must be obtained from a 3rd party source.

Electric Pumps

# Miniature Meter-Flo® Pump

## Versatile, All-In-One Pump Package

Designed for use with virtually any type of Series Progressive or Single Line Resistive oil lubrication system. The Miniature Meter-Flo's rugged steel reservoir and motor assembly withstands the toughest applications. Capable of high volumetric output operating continuously at pressures up to 2,000 psi (138 bar).



### Continuous Duty Motor

Ideal for circulating oil systems.

### Built-in Pressure Relief

Returns excess oil to the reservoir with no mess.

### Sensor Options

Factory-installed low level. Pressure switch sold separately.

### Oil Level Sight Glass

Provides visual indication of oil level.

### Steel Oil Tank

Rugged construction offered in three sizes.

### Typical Applications

- Ideal for smaller series progressive systems requiring continuous lubrication
- Adjustable, built-in pressure relief valve makes MMF packages compatible with resistive orifice systems.

### Typical Fluids

- Oil – 160 to 15,000 SUS

### Technical Specifications

Output Volume per minute	1, 5, 8, 14 in <sup>3</sup> (16, 82, 131, 229 cm <sup>3</sup> )
Output Pressure	300-2,000 psi (20.7-138 bar)
Material	Metal, Rectangular
Reservoir Size	1.5, 3 or 5 gal (5.7, 11.4 or 18.9 L)
Motor	115 VAC, 60 Hz, 1ph or 230 VAC, 50/60 Hz, 3 ph
Instruction Manual	L12600

## Ordering Information

### Miniature Meter-Flo (MMF) Models

Part Number	Reservoir Capacity gallons (liters)	Flow Rate in <sup>3</sup> /min (cm <sup>3</sup> /min)	Maximum PSI (Bar)
<b>Miniature Meter-Flo (MMF) 115 VAC Pumps with Reservoirs</b>			
MM1112	1.5 (5.7)	1 (16.4)	1,500 (103)
MM1113*		1 (16.4)	1,500 (103)
MM1212		5 (82)	2,000 (138)
MM1412		14 (229)	1,500 (103)
MM2112	3 (11.4)	1 (16.4)	1,500 (103)
MM2212		5 (82)	2,000 (138)
MM2412		14 (229)	1,500 (103)
MM3212	5 (18.9)	5 (82)	2,000 (138)
MM3412		14 (229)	1,500 (103)
<b>Miniature Meter-Flo (MMF) 230 VAC (3 phase) Pump with Reservoir</b>			
26A414	1.5 (5.7)	5 (82)	2,000 (138)

\*Part Number MM1113 includes dual level switch (high/low) part number 26C344.

### MMF Pump and Motor Assemblies, Without Reservoirs

Part Number	Description
564412	1 in <sup>3</sup> /min flow rate
564413	5 in <sup>3</sup> /min flow rate
564414	8 in <sup>3</sup> /min flow rate
564415	14 in <sup>3</sup> /min flow rate

### Additional MMF Spare Parts

557286	Motor, 115 VAC
557293	Gear box, 1 in <sup>3</sup> /min (12.5:1)
557822	Gear pump only, 1 to 8 in <sup>3</sup> /min
557821	Gear pump only, 14 in <sup>3</sup> /min
557810	Suction strainer
563558	Pressure relief valve
557825	Low level switch
26C344	High/low level switch

## Continuous Duty Durability

With its solid pump housing, these rugged gear pumps are designed for dependable operation in high demand applications. The gear pump is available with a direct-coupled 1/2 horsepower motor capable of 1,725 rpms with output volumes of 245 cubic inches per minute. Eleven different pump models to choose from.

### NPT or SAE Porting

Options for 1/2 in NPT or 7/8 in SAE O-Ring Boss.

### Solid Pump Housing

Rugged and durable for dependable operation.

### Drive Shaft with Woodruff Key

1/2 in (12.7 mm) drive shaft mates to standard couplings.

### Standard SAE 4-bolt Mounting

Simplifies installation.

### Adjustable Pressure Relief Valve

Protects pump against overload conditions.

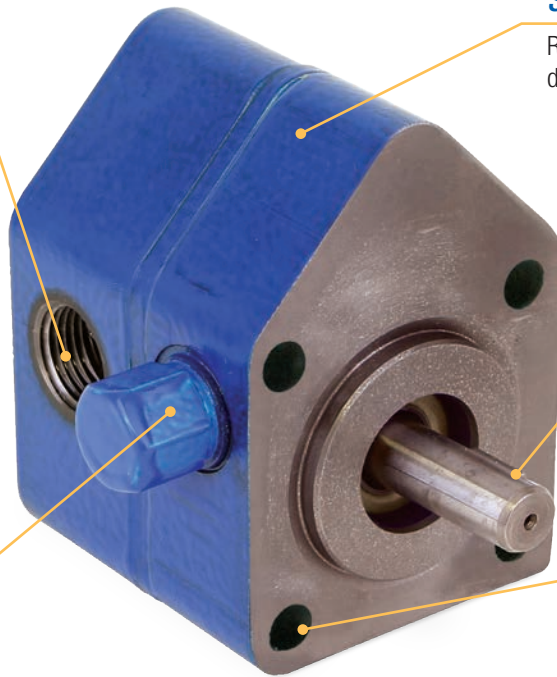

### Typical Applications

- Ideal for applications requiring continuous oil delivery up to 1,000 lubrication points

### Typical Fluids

- Oil – 300 to 3,000 SUS

### Technical Specifications

Output Volume Per Minute	14 to 245 in <sup>3</sup> (230 to 4,015 cm <sup>3</sup> )
Maximum Output Pressure	300 to 1,500 psi (20.7 to 103.5 bar)
Operating Temperature	50°F to 150°F (10°C to 65.5°C)
Instruction Manual	L12611

### Ordering Information



#### Meter-Flo Pumps

Part Number		Rotation	Displacement	
Port Thread			in <sup>3</sup> (cm <sup>3</sup> )/minute	
1/2 in NPT	7/8 in SAE		1,140 RPM	1,725 RPM
557813	–	CCW	18 (295)	30 (492)
557814	558953	CCW	9 (147)	14 (229)
557815	–	CCW	56 (918)	84 (1,377)
558949	–	CW	56 (918)	84 (1,377)
557816	–	CCW	76 (1,245)	117 (1,917)
558950	–	CW	76 (1,245)	117 (1,917)
557817	–	CCW	111 (1,819)	168 (2,753)
558951	–	CW	111 (1,819)	168 (2,753)
557818	558954	CCW	26 (426)	40 (655)
557819	–	CW	9 (147)	14 (229)
557820	–	CCW	161 (2,638)	245 (4,015)
558955	–	CW	161 (2,638)	245 (4,015)

Above displacements are nominal outputs at 600 psi (41 bar) using 350 SUS oil at 70°F (76 cSt @ 21°C). CW = Clockwise rotation / CCW = Counter-clockwise rotation when facing pump shaft

» Ordering Information

**Repair Kits**



	Part Number	Description
	557997	Meter-Flo seal kit
	557998	Meter-Flo relief valve repair kit

**Meter-Flo Paddle Base and Pump Packages**

Include motor mounting base, pump, L-bracket, coupler, coupler guard, and other small hardware needed to mount a 56F motor. Simply add any 56F motor (or 56C with feet) to complete the pump package.

Part Number	Description
563557	Paddle base with pump 557814
564411	Paddle base with pump 557813
24N405	Paddle base with pump 557815
24N406	Paddle base with pump 557816
24N407	Paddle base with pump 557817
24N408	Paddle base with pump 557818
24N409	Paddle base with pump 557820

**Additional Mounting Options for Meter-Flo Pumps** – pumps not included.

	Part Number	Description
	558956	Bell housing bracket and coupler kit – requires NEMA 56C motor with feet.
	561067	L-bracket – bare part for mounting Meter-Flo pump in a custom application

## Right-Sized Solution

The Graco Compact Dyna-Star (CDS) automatic lubrication system delivers high-capacity flow, robust durability and innovative control in a smaller footprint to extend uptime for today's toughest earth-moving machines and users in the harshest environments.

### Rugged Durability

Metal construction ensures trustworthy operation in the most extreme environments.

### Integrated Auto-Fill Shut-Off

This option enables single-person, powered-down, ground-level refills, without the need to climb or worry about spills.

### Smart Power Train

24 VDC, brushless motor and zero-maintenance gear drive deliver lubricants on time, even at -40° F (-40° C).

### Intelligent Monitoring

Optional pressure and lubricant level sensors provide useful system information in real time.

### Compact Power

Fits easily in space-limited applications; powerful enough to keep up with aggressive lubrication interval.



### Typical Applications

- Aggregates
- Mining
- Construction
- Hydraulic Fracturing Units

### Typical Fluids

- Oil and grease up to NLGI #2

### Technical Specifications

Maximum Working Pressure	3,500 psi (241 bar)
Operating Temperature	-40° F to 149° F (-40° C to 65° C)
Reservoir Size	12 L, 20 L, or 60 lb (30 L) reservoir or 35 lb (20 L) pail option
Maximum Flow Output Rate	4.5 in <sup>3</sup> /min (74 cm <sup>3</sup> /min)
Certifications/Ratings	IP69K
Instruction Manual	3A6941

## Ordering Information

Pump Description		CD	X	X	X	X
<b>Code</b>	<b>Description</b>					
1	12 L / 35 lb bucket length, 24 VDC					
2	20 L reservoir length, 24 VDC					
3	3 60 lb (30 L) reservoir length, 24 VDC					
Metering System Feedback						
<b>Code</b>	<b>Description</b>					
0	Series progressive, no vent-valve, no pressure feedback (plugged outlet)					
1	Vent-valve, no pressure feedback (plugged outlet)					
2	Vent-valve, pressure switch					
3	Vent-valve, pressure-reporting transducer					
Reservoir						
<b>Code</b>	<b>Description</b>					
0	No reservoir, bare pump					
1	12 L steel reservoir, follower plate					
2	20 L steel reservoir, follower plate					
3	35 lb plastic bucket kit – cover, follower plate (bucket not included)					
4	12 L steel reservoir, no follower plate					
5	20 L steel reservoir, no follower plate					
6	60 lb (30 L) steel reservoir, follower plate					
7	60 lb (30 L) steel reservoir, no follower plate					
Reservoir Accessories						
<b>Code</b>	<b>Description</b>					
0	Bare pump or bucket kit (no reservoir)					
1	Low-level switch					
2	Level-reporting transducer					
3	Auto-fill shut-off and low-level switch					
4	Auto-fill shut-off and level-reporting transducer					



## Compact Dyna-Star Accessories

	Part Number	Description
	26A883	GLC X to CDS 3 ft (1 m) cable
	26A884	CDS extension cable, 12-wire, 20 ft (6 m) with flying leads
	26A889	12-pin DT female CDS mating connector kit
	25R001	12 liter reservoir wall mount bracket
	25R318	Mounting bracket for GLC X, Red Alert filter, 3- and 5-section MSP assemblies or 3- and 5-bank GCI and GL-1 series injectors

Electric Pumps

## Pair with the GLC® X Controller and Auto Lube™ App

The all-new Bluetooth®-enabled GLC X controller and Auto Lube app will offer easy programming and real-time data for a wide range of auto-lube systems, even competitors' pumps.



**Easy-to-Read Screen**  
High-contrast screen features text codes, faults and other data clearly in any ambient light.



**Real-Time System Reporting**  
Program and display a wide range of customizable functions.

**Smart Device and Mobile App**  
With the Auto Lube app, monitor lubrication levels, configure settings, track history and share important diagnostics.



Part Number	Description
26A855	GLC X controller with 20 ft (6 m) cable
26A814	GLC X controller
26A882	GLC X wiring harness, 12-wire, 20 ft (6 m) with flying leads

## Accessories

	Part Number	Description
	26A853	GLC X pump and sensor simulator
	26A882	GLC X 20 ft (6 m) cable
	26A883	GLC X to Compact Dyna-Star® 3 ft (1 m) cable
	26A888	14-pin mating connector kit

# Electric Dyna-Star® HP and Dyna-Star HF

## The Rugged Workhorse

The Graco Electric Dyna-Star (EDS) pumps are built on a heavy steel reservoir with common bolt pattern to easily replace older designs. The time-proven Graco Advantage Drive is combined with existing Graco barrel pump lowers to provide performance you can depend on.

### Safely Move Pump

Built-in lift ring is rated to 500 lbs (226 kg).

### M23 Connector

Saves installation time.

### Graco Advantage Drive™

Hardened steel gears are lubricated for life and sealed to keep contaminants out for longer-lasting performance.

### Adjustable Motor and Amp Control

Make adjustments with the turn of a dial. LED status lights.

### Direct-Mount Electric Vent Valve

Compact design means fewer parts to break or wear out.

### Mechanical Auto-Fill Shut Off

Shuts off the fill pump for clean, trouble-free refilling without electronics.

### Low-Level Sensor

Alerts low grease status and self-clears without a follower plate.

### Strong 12-Gauge Steel Reservoir

Available in 60 lb (27 kg) or 90 lb (41 kg) reservoirs. Matches common bolt pattern.

### Tube-in-Tube

Provides simple and direct venting and filling to the foot of the pump.

### Remote Fill Manifold

Enables clean and efficient ground-level filling up to 5,000 psi (344 bar).

#### Typical Applications

- Mining Operations
- Milling and Crushing
- Heavy-duty Construction
- Well Services
- Industrial  
(see part number 77X524 for AC to DC Converter)

#### Typical Fluids

- Oil and grease up to NLGI #2

## Technical Specifications

	HF Models	HP Models
Max Output Volume Per Minute	1.5 to 35 in <sup>3</sup> /min (24.6 to 574 cm <sup>3</sup> /min)	1.5 to 18 in <sup>3</sup> /min (24.6 to 295 cm <sup>3</sup> /min)
Maximum Outlet Pressure	3,500 PSI (241 bar)	5,000 PSI (344 bar)
Certifications/Ratings	IP69K	
Inlet/Outlet Sizes		
Tank/Reservoir Fill Port	1/2 in NPT	
Overflow Port	1/2 in NPT	
Fluid Outlet Size	3/8 in NPT	
Operating Temperature	14°F to 149°F (-10°C to 65°C)	-40°F to 149°F (-40°C to 65°C)
Power	24 VDC	
Instruction Manual	332514	



## Ordering Information

### Stand Alone Pumps

	Part Number	Description
	77X000	24 VDC HP stand-alone pump for 35 or 60 pound reservoir
	77X001	24 VDC HP stand-alone pump with tube-in-tube for 35 or 60 pound reservoir
	77X002	24 VDC HP stand-alone pump with tube-in-tube for 90 or 120 pound reservoir
	77X003	24 VDC HP stand-alone pump with tube-in-tube for 400 pound reservoir
	77X014	24 VDC HF stand-alone pump for 35 or 60 pound reservoir
	77X015	24 VDC HF stand-alone pump for 120 pound reservoir
	77X016	24 VDC HF stand-alone pump for 400 pound reservoir

### HP Pump Modules

Reservoir Size		Vent Valve	Dip Stick	Low Level 77X522 (DIN)	Follower Plate	Low Level 17L372 (M12)	Auto-Fill Shut Off
60 lb (27 kg)	90 lb (41 kg)						
77X100	77X101	•	•				
77X102	77X103	•					•
77X104	77X105	•		•	•		
77X202	77X203	•				•	•
77X204	77X205	•				•	
77X300	77X301		•				
77X304	77X305			•	•		
77X402	77X403					•	•

### Complete System Installation Kits

	Part Number	Description
	77X960	24 VDC HP pump with auto-fill shut off and low-level monitor, GLC 2200 controller, wiring harness, low-level sensor cable, power cable, pressure switch, and remote fill manifold for 60 pound reservoir.
77X990	24 VDC HP pump with auto-fill shut off and low-level monitor, GLC 2200 controller, wiring harness, low-level sensor cable, power cable, pressure switch, and remote fill manifold for 90 pound reservoir.	

## Ordering Information

### Custom Tank Injector Kits

Part Number	Description
77X011	24 VDC HP pump and vent valve with tube-in-tube for 35 or 60 pound reservoir
77X012	24 VDC HP pump and vent valve with tube-in-tube for 90 or 120 pound reservoir
77X013	24 VDC HP pump and vent valve with tube-in-tube for 400 pound reservoir



### Standard Drum Injector Kits

Part Number	Description
77X111	24 VDC HP pump, vent valve, and cover with tube-in-tube for 120 pound reservoir
77X112	24 VDC HP pump, vent valve, and cover with tube-in-tube for 400 pound reservoir

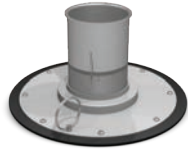

### Standard Drum Kits

Part Number	Description
77X121	24 VDC HF pump and cover for 120 pound reservoir
77X122	24 VDC HF pump and cover for 400 pound reservoir

### Follower Plates and Covers

	Container Size				Description
	35 Pound Bucket	60/90 Pound Graco Reservoir	120 Pound Refinery Drum	400 Pound Refinery Drum	
	77X510	77X500	77X511	77X512	Follower plate for pumps with tube-in-tube
		247700	247701	247702	Follower plate for pumps without tube-in-tube
	77X513	–	77X514	77X515	Drum cover

### Accessories

	Part Number	Description
	77X521	Auto-fill Shut Off (AFSO) – diaphragm, plate, valve, coupler and pipes. Can be used to add AFSO to an EDS module that shipped without it, or as replacement part(s) for existing AFSO modules.
	77X522	Low level kit sight glass, electric low level switch and cable (requires follower plate 77X500)
	77X523	400 micron inline filter, maximum 5,000 psi (344 bar) inlet pressure (replacement filter 77X541)

## Ordering Information

### Accessories

	Part Number	Description
	17L366	Red alert filter with 380µm, 36 in <sup>2</sup> steel mesh filter (replacement filter 129031)
	24R952	Red alert filter with reservoir mounting kit (includes 17L366)
	16V678	Red alert filter mounting bracket
	77X524	110-230 VAC to 24 VDC converter box
<i>Image Coming Soon</i>	77X540	24 VDC electric vent valve with pressure relief
	77X542	Remote-fill manifold with vent
<i>Image Coming Soon</i>	77X543	HF output manifold with 4,000 psi pressure relief
	77X544	HP output manifold with 5,000 psi pressure relief
<i>Image Coming Soon</i>	77X545	Power cable for series progressive systems (pumps <i>without</i> a Vent Valve), M23 connector, 15 ft (4.6 m)
<i>Image Coming Soon</i>	77X546	Power cable for injector systems (pumps <i>with</i> a Vent Valve), M23 connector, 15 ft (4.6 m)
	115124	Pressure switch – pressure adjustment visible in window
	24N181	Pressure switch, 1/4 in NPT(F) inlet, DIN 43650 connector (1 NO/1 NC), 7,250 psi (500 bar)

# Manzel® MBL Box Lubricators

## Force Feed Box Lubricators

The Manzel® Modular Box Lubricator (MBL) provides true modularity that permits customizing a pump-to-point lubrication system from off-shelf components. MBL pumping packages can also be used with MHH divider valves in a series progressive system. Each moving part is lubricated at all times by the fluid in the reservoir. This and the wide range of options, high discharge pressure and rugged construction make the MBL ideally suited for a wide variety of industries and applications.

### GBL 7500 Pumps

Modern design that has become the industry standard. See page 54 for pump part numbers.

### Suction Pumps Installed

Use ordering menu on page 55 to specify pumps to be installed. Gravity and Pressure Feed pumps are sold separately for field installation.

### Modular Drive

External drive assemblies available as replacement parts.



### Heater Port

Integrated 1 in NPT port makes optional electric heater installation simple.

### Heavy Steel Reservoirs and Mounting Bases

Eight reservoir capacities are available to hold up to 40 pints and 24 pumps.

### Technical Specifications

Maximum Pressure	7,500 psi (517 bar)
Power	115/230 VAC, 230/460 VAC, 60 Hz
Operating Temperature	-20°F to 140°F (-29°C to 60°C)
Reservoir Size	See the following pages
Maximum Run Time	Continuous
Output per Element/Min	0.7, 1.2, or 2.7 in <sup>3</sup> (11.45, 19.65, or 44.25 cm <sup>3</sup> )
Certifications/Standards	ATEX (depends on configuration)
Instruction Manual	3A2100

### Typical Fluids

- Mineral oil or synthetic based lubricants
- 80 to 5,000 SUS

### Typical Applications

- Compressors – petrochemical, refineries, gas transmission and more
- Edgers, planers and band saws
- Rubber mixers
- Cannery lid presses

## Manzel® MBL Pump/Reservoir Combinations with Motor Mounting Bases

**NOTE:** All part numbers on the chart below use "OA" (Zero-A) to indicate assemblies with NO pumps. Refer to Smart Code ordering details.

### End Rotary Drives

Add GBL 7500 pumps and a NEMA 56F motor, or 56C with feet, to complete the assembly – see motor options on page 55.

Drive Ratio	Reservoir Size				
	4 pint (1.9 L)/ 2 Feed	6 pint (2.8 L)/ 3 Feed	8 pint (3.8 L)/ 5 Feed	12 pint (5.7 L)/ 8 Feed	16 pint (7.6 L)/ 12 Feed
50:1	MBJOAK	MBKOAK	MBLOAK	MBMOAK	MBNOAK
100:1	MBJOAL	MBKOAL	MBLOAL	MBMOAL	MBNOAL
200:1	MBJOAM	MBKOAM	MBLOAM	MBMOAM	MBNOAM
400:1	MBJOAN	MBKOAN	MBLOAN	MBMOAN	MBNOAN
Replacement Camshaft	564166	564167	564170	560381	564179

### Heavy Duty Gearbox Drives

Add GBL 7500 pumps and a NEMA 56C motor to complete the assembly – see motor options on page 55.

Drive Ratio	Reservoir Size		
	24 pint (11 L)/ 16 Feed	32 pint (15 L)/ 20 Feed	40 pint (19 L)/ 24 Feed
400:1	MBPOAY	MBROAY	MBSOAY
Replacement Camshaft	564166	564167	564170

### MBL Replacement Parts

25T989	Cam replacement kit – includes cam, key, and set screw for one pump station. For replacement cam shafts, see tables above.
--------	--

### Replacement Gearboxes

Drive Letter from Ordering Menu	Drive Ratio	Spare Part Number	Compatible with Reservoir/Base J – N?
J	25:1	564055	No*
K	50:1	564054	Yes
L	100:1	563121	Yes
M	200:1	563122	Yes
N	400:1	563120	Yes

\*25:1 ratio is too low for use with 1,725 rpm motor.

Drive Letter from Ordering Menu	Drive Ratio	Spare Part Number
Y	400:1	557162

## Ordering Information

### MBL Smart Code Ordering Menu

MB - X - X - X - X

#### Reservoir (Smart Code Option A)

Code	Former Code(s)	Description	Code	Former Code(s)	Description
A	T1	4 pt (1.9 L), 2 pump stations max	J	T1 and P1	4 pt, 2 pump stations max, motor mount base
B	T2	6 pt (2.8 L), 3 pump stations max	K	T2 and P2	6 pt, 3 pump stations max, motor mount base
C	T3	8 pt (3.8 L), 5 pump stations max	L	T3 and P3	8 pt, 5 pump stations max, motor mount base
D	T4	12 pt (5.7 L), 8 pump stations max	M	T4 and P4	12 pt, 8 pump stations max, motor mount base
E	T5	16 pt (7.6 L), 12 pump stations max	N	T5 and P5	16 pt, 12 pump stations max, motor mount base
F	T6	24 pt (11.4 L), 16 pump stations max	P	T6 and P6	24 pt, 16 pump stations max, motor mount base*
G	T7	32 pt (15.1 L), 20 pump stations max	R	T7 and P7	32 pt, 20 pump stations max, motor mount base*
H	T8	40 pt (18.9 L), 24 pump stations max	S	T8 and P8	40 pt, 24 pump stations max, motor mount base*

\*Cannot use double reduction or right angle drives.

#### Pump Size – GBL 7500 Suction Pumps (Smart Code Option B)

Code	Former Code(s)	Description
0	00	No pumps
1	76/88B	3/16 in Suction Pump 24J391
2	76/88C	1/4 in Suction Pump 24J392
3	76/88E	3/8 in Suction Pump 24J393
4	76/88B and F3	3/16 in Suction Pump plus RENS Level Controller
5	76/88C and F3	1/4 in Suction Pump plus RENS Level Controller
6	76/88E and F3	3/8 in Suction Pump plus RENS Level Controller
7	76/88B and F4	3/16 in Suction Pump plus GARZO Level Controller
8	76/88C and F4	1/4 in Suction Pump plus GARZO Level Controller
9	76/88E and F4	3/8 in Suction Pump plus GARZO Level Controller

#### NOTES:

1. When pump quantity is less than maximum pump stations of specified reservoir, a blank cover assembly is installed at Graco.
2. When low level is specified, deduct one pump for each option.
3. When ordering a ratchet drive, the maximum number of pumps allowable is 20.

#### Pump Quantity (Smart Code Option C)

Code	Qty	Code	Qty	Code	Qty	Code	Qty	Code	Qty	Code	Qty
A	0	E	4	J	8	N	12	T	16	X	20
B	1	F	5	K	9	P	13	U	17	Y	21
C	2	G	6	L	10	R	14	V	18	Z	22
D	3	H	7	M	11	S	15	W	19		

#### Drive Options (Smart Code Option D)

Code	Former Code	Description	Code	Former Code	Description
A	G01R	Direct End Rotary (50 rpm max)	H	G04L	End Rotary Ratchet 75:1 – max input of 800 RPM
B	G02R	End Ratchet (without drive arm 563005)	J	G05R	Double Reduction End Rotary 25:1
C	G03R	End Rotary Ratchet 37-1/2:1 – max input of 800 RPM	K	G06R	Double Reduction End Rotary 50:1
D	G04R	End Rotary Ratchet 75:1 – max input of 800 RPM	L	G07R	Double Reduction End Rotary 100:1
E	G01L	Direct End Rotary	M	G08R	Double Reduction End Rotary 200:1
F	G02L	End Ratchet (without drive arm 563005)	N	G09R	Double Reduction End Rotary 400:1
G	G03L	End Rotary Ratchet 37-1/2:1 – max input of 800 RPM	Y	G18R	400:1 Ratio Gear Reducer**

\*\*Y (G18) requires motor mounting base; can only be used with reservoir options P, R and S.

Ordering Information

MBL Box Lubricator Motors

	Part Number	Description
	558289	M2 – 1/4 hp, 1,725 rpm, 115/230V, 1 ph., TENV, Foot-Mounted (56F)
<i>Image Coming Soon</i>	558293	M3 – 1/4 hp, 1,725 rpm, 115/230V, 1 ph., Hazardous Area, Class 1, Group D, Foot-Mounted (56F)
	558290	M5 – 1/4 hp, 1,725 rpm, 230/460V, 3 ph., TENV, Foot-Mounted (56F)
<i>Image Coming Soon</i>	558292	M6 – 1/4 hp, 1,725 rpm, 230/460V, 3 ph., Hazardous Area, Class 1, Group D, Foot-Mounted (56F)
	558294	M7 – 1/2 hp, 1,725 rpm, 115/230V, 1 ph., Hazardous Area, Class 1, Group C, Severe Duty, Tropical Insulation, Face-Mounted or Foot-mounted (56C with feet)
<i>Image Coming Soon</i>	558291	M10 – 1/2 hp, 1,725 rpm, 230/460V, 3 ph., 60Hz, Class 1, Group D, Face-Mounted (56C)
	557271	M11 – 1/2 hp, 1,725 rpm, 115/230V, 1 ph., 60Hz, TEFC, Face-Mounted (56C)
	557270	M12 – 1/2 hp, 1,725 rpm, 230/460V, 3 ph., 60Hz, TEFC, Face-Mounted (56C)

NOTE: Heavy Duty drive “Y” (G18R) requires 56C, face-mount. Normally a 1/2 hp motor would be used because more pumps are being operated by the HD drives.

Electric Pumps

## Ordering Information

### Auto Fill Options

	Part Number	Description
	559037	F1 Gravity Supply

NOTE: F2 – obsolete, use F1 instead. F3 – ordered with pumps (see page 55). F4 – ordered with pumps (see page 55).

### Low Level Switches

	Part Number	Description
	563013	L1 – Low Level Switch Hazardous Area. Class 1, Group C and D; Class 2 Group, E, F and G.
	564015	L2 – Low Level, 10 Watts at 120 VAC, SPST Reed Switch, NC

### Shaft Rotation Alarm

	Part Number	Description
	24K466	GBL 7500 Shaft Rotation Alarm Pump



### Heater Options

	Part Number	Description
<p><i>Image Coming Soon</i></p>	557207	120 VAC Electric Heater, Hazardous Area, Class 1, Group B, one-prong heater. Can be installed in 1 in NPT port on MBL reservoirs.

NOTE: Former codes H3, H4 and H6 use 557207. For H1, H2 and H5, contact factory for details about part number 564058 (two prong heater) Class 1, Group D

### Day Tank Options

Modu-Flo oil tanks include 1/2 in NPSF female thread at the bottom of the tank to receive a 1/2 in NPT male fitting.

	Part Number	Description
	563319	12 pt Tank
	563320	24 pt Tank
	563321	40 pt Tank



# Pneumatic Pump Selection Guide

Pump Family	Typical Applications	Fluid Type	Maximum Output Pressure psi (bar)	Maximum Output Volume in <sup>3</sup> (cm <sup>3</sup> )	Reservoir Capacity Options		Metering	Reference Page
					US	Metric - Liters		
 <p><b>LubePro™</b></p>	<ul style="list-style-type: none"> <li>• Energy, Infrastructure and Heavy Equipment</li> <li>• In-Plant Manufacturing</li> </ul>	40 cSt oil minimum / grease up to NLGI #2	3,500 to 4,000 (241 to 276)	Single Stroke Pumps – 0.56 to 3.0 (9.2 to 49.2) per stroke Reciprocating Pumps – 50 (819) per minute	Oil – 1.3, 4.2, 5 or 12 pints Grease – 1, 4, 6 or 12 lbs	Oil – 0.6, 2.0, 2.4 or 5.5 Grease – 0.5, 2, 3 or 6	SLP	59-63
 <p><b>LubriSystem</b></p>	<ul style="list-style-type: none"> <li>• In-Plant Manufacturing</li> </ul>	Oil/grease up to NLGI #1	1,350 (93)	1.5 (25) per stroke	Oil – 6, 12 or 20 pints Grease* – 3, 6 or 12 lbs	Oil – 2.8, 5.5 or 9 Grease – 1.5, 3, or 6	SLP	64-65
 <p><b>Modu-Flo®</b></p>	<ul style="list-style-type: none"> <li>• Energy, Infrastructure and Heavy Equipment</li> <li>• In-Plant Manufacturing</li> </ul>	Oil/grease up to NLGI #2	3,000 (207)	0.030, 0.120 or 0.240 (0.5, 2.0 or 3.9) per stroke	Oil – 5, 6, 12, 20, 24 or 40 pints Grease* – 3, 6, or 12 lbs	Oil – 2.4, 2.8, 5.5, 9, 11 or 19 Grease – 1.5, 3, or 6	SPDV	66-70
 <p><b>E-Series</b></p>	<ul style="list-style-type: none"> <li>• In-Plant Manufacturing</li> <li>• Vehicle service</li> </ul>	Oil up to 30,000 SUS / grease up to NLGI #2	2,000 (138)	0.030 (0.5) per stroke	Oil – 4 pints Grease* – 3 or 6 lbs	Oil – 1.9 Grease – 1.5 or 3	SPDV	71-72
 <p><b>MSA-10 and MSA-100</b></p>	<ul style="list-style-type: none"> <li>• In-Plant Manufacturing</li> </ul>	Oil/grease up to NLGI #2	3,000 (207)	0.120 or 0.800 (2 or 13) per stroke	N/A	N/A	SPDV	73-74
 <p><b>Pneumatic Dyna-Star® Fire-Ball® 300 50:1</b></p>	<ul style="list-style-type: none"> <li>• Energy, Infrastructure and Heavy Equipment</li> <li>• In-Plant Manufacturing</li> </ul>	Oil/grease up to NLGI #2	3,500 (241)	54 (85) per minute	60 or 90 lb	30 or 45	SPDV or SLP	75-76

\*See page 69 for note on legacy Trabon grease reservoir volumes and metric conversions.



= Single Line Parallel (Injectors)



= Series Progressive Divider Valve

## For Simple, Injector-based Automatic Lubrication Systems

As a hard-working professional focused on ensuring your production lines keep moving and your operating costs are reduced, automatic lubrication should be an essential part of your machine maintenance. Without proper lubrication your equipment can suffer from downtime and reduced life, which impacts your company's bottom line. Avoid the hassle. Meet your LubePro.™



Pneumatic Pumps

### Typical Applications

- Packaging
- Food and Beverage Processing and Packaging
- Glass Manufacturing
- Tire Production
- Thermoforming
- Injection Molding
- Paper Production
- Labelers
- Automation Machinery
- Presses
- Steel Forging and Finishing
- Bearing Manufacturing

### Typical Fluids

- 40 cSt oil minimum
- NLGI #000 to NLGI #2 grease

# A4000 Reciprocating Pump

### Two Models Available

Oil or grease: 4,000 psi (276 bar).

### Low Level Detection

Available as a factory-installed option. Easy to connect, comes with field-wireable DIN connector; NO or NC.

### Simple Controlling

PLC or lube controller actuates a 3-way air valve to drive pump and vent valve to relieve pressure in the system once lube cycle is complete.

### Pneumatic Power

Easily installed into existing air line.

### Multiple Reservoir Types

Oil without follower plate – 5.5 liter.  
Grease with follower plate – 7.5 lbs / 13 lbs.

### Easy to Install

Utilize existing mounting holes for easy replacement and installation.

### Fast Cycle Rate and Flow

Output of up to 50 in<sup>3</sup>/min (819 cc/min).

### Vent Valve

integrated pneumatic or electric vent valve.

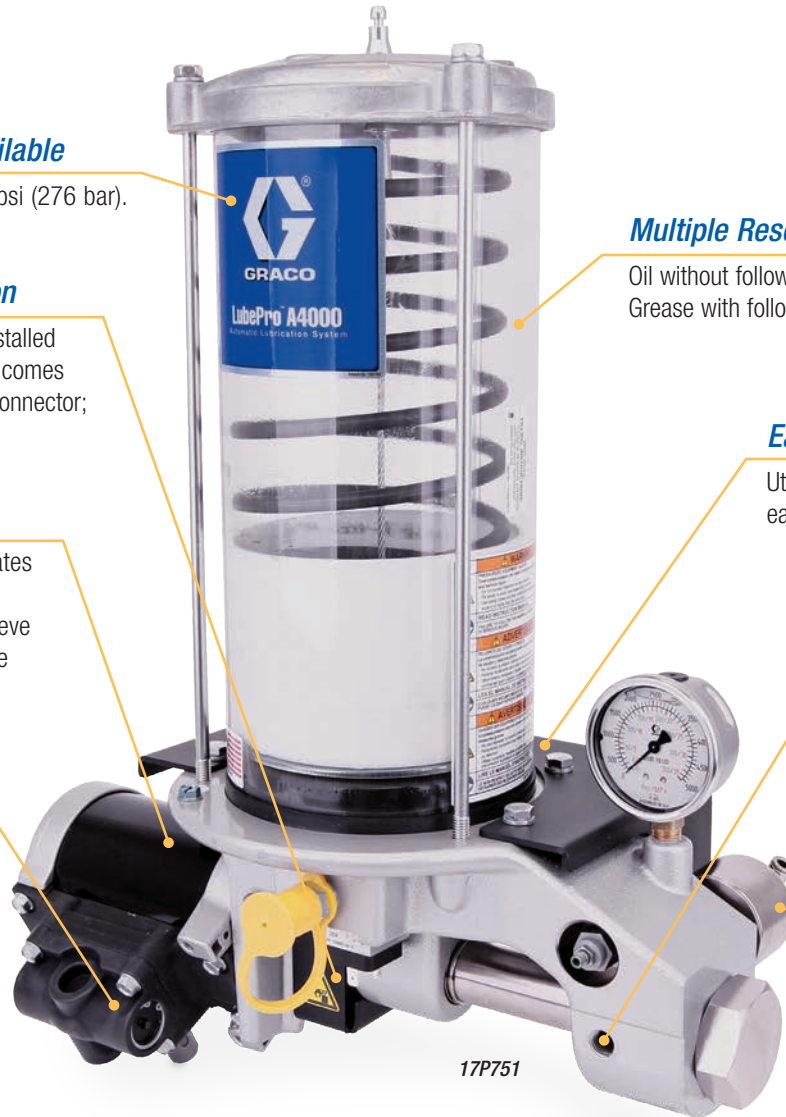

## Technical Specifications

Fluid Handling Capabilities	40 cSt oil - #2 grease
Maximum Working Pressure	4,000 psi (276 bar)
Pressure Ratio	40:1
Pump Output Per Minute	50 in <sup>3</sup> (819 cm <sup>3</sup> )
Maximum Air Inlet Pressure	100 psi (6.89 bar)
Air Inlet Size	1/4 in NPT
Fluid Outlet Size	1/4 in NPT
Operating Temperature	14°F to 149°F (-10°C to 65°C)
Instruction Manual	3A5266

## Ordering Information

Fluid	Pressure Ratio	Reservoir Size	Low Level Detection	Pneumatic Vent Valve	Electric Vent Valve	Series Progressive
Oil	40:1	12 pints (5.5 L)	–	17P752	17T195	17T178
			Yes	17P753	17T196	17T179
Grease	40:1	6 lbs (3 L)	–	17P750	17T193	17T176
			Yes	17P751	17T194	17T177
		12 lbs (6 L)	Yes	17U217	–	–

# A2800 and A2900 Vertical Pumps

## High-Strength, Shatter-Resistant Reservoir

Utilizes a high-quality, polycarbonate reservoir.

## Self-Venting Pump

Integrated vent automatically relieves pressure on return stroke, no pressure switch or wiring required.

## Simple Controlling

PLC or Lube controller actuates a 3-way air valve to drive pump, and vent on the return stroke.

## Fast Cycle Rate and Flow

Cycles and vents lubricant injectors in as little as 10 seconds. 0.56 in<sup>3</sup> of oil per stroke and 0.58 in<sup>3</sup> of grease per stroke.

## Multiple Reservoir Types

Oil without follower plate – 0.6 and 2 liter.  
Grease with follower plate – 1 and 4 lb.

## Easy to Install

Utilize existing mounting holes for easy replacement and installation.

## Low Level Detection

Reliable, Graco factory-installed low level indicator that is easy to connect using a simple DIN connection.

## Pneumatic Power

Easily installed into existing air line.



### Technical Specifications

	A2800	A2900
Fluid Handling Capabilities	40 cSt oil minimum	Up to #2 grease
Maximum Working Pressure	3,500 psi (241 bar)	3,500 psi (241 bar)
Pressure Ratio	28:1	29:1
Pump Output Per Stroke	0.56 in <sup>3</sup> (9.18 cm <sup>3</sup> )	0.58 in <sup>3</sup> (9.5 cm <sup>3</sup> )
Maximum Air Inlet Pressure	175 psi (12.1 bar)	175 psi (12.1 bar)
Air Inlet Size	1/4 in NPT	
Fluid Outlet Size	1/4 in NPT	
Operating Temperature	14°F to 149°F (-10°C to 65°C)	
Instruction Manual	3A4033	3A4096

### Ordering Information

Pump Model	Fluid	Pressure Ratio	Reservoir Size	NPT		BSPP	
				Pump Without Low Level	Pump With Low Level	Pump Without Low Level	Pump With Low Level
A2800	Oil	28:1	0.6 liters	24Z020	24Z021 (NO)	24Z023	24Z024 (NO)
					24Z022 (NC)		24Z025 (NC)
			2 liters	24Z026	24Z027 (NO)	24Z029	24Z030 (NO)
					24Z028 (NC)		24Z050 (NC)
A2900	Grease	29:1	1 lb	24Z051	24Z052 (NO)	24Z054	24Z055 (NO)
					24Z053 (NC)		24Z056 (NC)
			4 lb	24Z057	24Z058 (NO)	24Z060	24Z061 (NO)
					24Z059 (NC)		24Z062 (NC)



24Z028

# H1900, A1900 and A2600 Horizontal Pumps

## Two Reservoir Types

2 liter reservoir available in grease or oil. Select from the 19:1 oil pump or the 26:1 grease pump.

## High-Strength, Shatter-Resistant Reservoir

Utilizes a high-quality, polycarbonate reservoir that is securely mounted to the pump with rigid tie rods for optimal sealing.

## Easy to Install

Utilize existing mounting holes for easy replacement and installation.

## Fire-Ball Pump Casting

Leverages the proven quality and long life of Graco's Fire-Ball pump. Eliminates tie rods and end cap.

## Low Level Detection Option

Reliable, Graco factory-installed low level indicator that is easy to connect using a simple DIN connection.

## Fast Cycle Rate and Flow

Cycles and vents lubricant injectors in as little as 10 seconds. 2.2 in<sup>3</sup> of grease per stroke and 3.0 in<sup>3</sup> of oil per stroke.

## Self-Venting Pump

Integrated vent automatically and reliably relieves pressure on return stroke, no pressure switch or wiring required.

## No Priming Required

No need to bleed the valve to prime the pump, no priming is required.

## Pneumatic Power

Easily installed into existing air line.



17C750

Pneumatic Pumps

Technical Specifications				
	H1900	A1900	A2600	
Fluid Handling Capabilities	40 cSt oil minimum	40 cSt oil minimum	Up to #2 grease	
Maximum Working Pressure	3,500 psi (241 bar)	3,500 psi (241 bar)	3,500 psi (241 bar)	
Pressure Ratio	19:1	19:1	26:1	
Pump Output Per Stroke	3.0 in <sup>3</sup> (49.16 cm <sup>3</sup> )	3.0 in <sup>3</sup> (49.16 cm <sup>3</sup> )	2.2 in <sup>3</sup> (36.05 cm <sup>3</sup> )	
Maximum Air Inlet Pressure	185 psi (12.8 bar)	185 psi (12.8 bar)	135 psi (9.3 bar)	
Air Inlet Size	1/4 in NPT			
Fluid Outlet Size	3/4 in NPT			
Operating Temperature	14°F to 149°F (-10°C to 65°C)			



24Y499

## Ordering Information

Pump Model	Fluid	Pressure Ratio	Reservoir Size	NPT		BSPP	
				Pump Without Low Level	Pump With Low Level	Pump Without Low Level	Pump With Low Level
H1900	Oil	19:1	—	24Y498	24Y499	25Y498	25Y499
A1900	Oil	19:1	2 liters	17C753	17C752	18C753	18C752
A2600	Grease	26:1	4 lb	17C750	17C751	18C750	18C751



17C753

Ordering Information

LubePro Accessories

	Part Number	Description	Maximum Working Pressure	Pump Compatibility						
				A1900	H1900	A2600	A2800	A2900	A4000	
	105474	3-way air valve, 150 psi (10 bar), 1/2 NPSM(F) conduit ports for wiring, 1/4 NPT(F) air ports. 24 VDC/120 VAC	150 psi (10.3 bar)				•	•	•	
	128305	4-way air valve, 12 VDC		•	•	•				
	128254	4-way air valve, 24 VDC		•	•	•				
	128255	4-way air valve, 120 VAC		•	•	•				
	128257	4-way air valve, 240 VAC		•	•	•				
	560734	Air valve reservoir mounting bracket		•		•				
<i>Image Coming Soon</i>	24Y079	4-way air valve installation kit – 12 VDC air valve, bracket, air lines, fittings		•		•				
	24Y080	4-way air valve installation kit – 24 VDC air valve, bracket, air lines, fittings		•		•				
	24Y081	4-way air valve installation kit – 120 VAC air valve, bracket, air lines, fittings		•		•				
	24Y082	4-way air valve installation kit – 240 VAC air valve, bracket, air lines, fittings		•		•				
	121474	Female coupler. Quick-disconnect. 1/4 in NPT. Mates with fill stud on LubePro grease pumps.		3,700 psi (255 bar)	•	•	•	•	•	•

Pneumatic Pumps

## Air Operated Pump for Single Line Parallel Systems

Easy to design, modify and adjust for oil or grease applications. Combine with LubriSystem/Grease Jockey injectors or Injecto-Flo piston distributors for easy, low cost system design solutions. Efficient design promotes increased productivity and less downtime. Offers several reservoir choices for both oil and grease applications

### Options For Oil And Grease

Grease reservoirs include follower plate and spring for up to NLGI #1 grease. Oil reservoirs are also available in 6, 12, and 20 pint.

### Standard Low Level Switch Options

Uses the same switch kits as many other Trabon® pumps, with options for oil and grease.

### Rugged Polycarbonate Reservoir

The “plastic” reservoir options utilize a polycarbonate tube or convert to a steel reservoir for an even tougher material.

### Trabon® Fill Stud

Uses mating coupler that is common to other Trabon pump packages.

### Self-Venting Pump

Integrated vent automatically relieves pressure on return stroke, no pressure switch or wiring required.

### 9:1 Pump Ratio

Same reliable design as the classic Grease Jockey and A900 pumps, but with more reservoir options for added flexibility.



Technical Specifications	
Output per Stroke	1.5 in <sup>3</sup> (24.6 cm <sup>3</sup> )
Maximum Output Pressure	360 to 1,350 psi (25 to 93 bar)
Air Inlet Pressure	40 to 150 psi (3 to 10 bar)
Ratio	9:1
Reservoir Material	Plastic (polycarbonate)
Instruction Manual	L12100

- ### Typical Fluids
- Oil and grease up to NLGI #1

- ### Typical Applications
- In-plant equipment and machinery

Ordering Information

**LubriSystem Pump Packages**

Low Level Option		Reservoir Size	Replacement Reservoir	Low Level Switch
Included	Not Included			

**Grease Packages**

563572	563571	6 lb	562907	563322
563573	—	12 lb	562896	

**Oil Packages**

563577	563574	6 pt	-	563014
563578	563575	12 pt	562892	563015
—	563576	20 pt	562893	563016

For a metal reservoir, refer to Lube Master section and select from those four options, then combine with bare pump 563579.

**Bare Pump**

Part Number	Repair Kit	Description
563579	563762	Pump includes Trabon fill stud and hardware to receive reservoir.

**Air Solenoid Valves**

150 psi maximum pressure, 1/4 in NPT female inlet.

Voltage		Air Outlet	Valve Ways	Air Motor Action
24 VDC	120 VAC			
563332	563315	1/4 in NPSF male banjo	3-way	Single

## True Modularity

Wide choice of standard modular components helps you meet application requirements more exactly without the added cost of a custom system. A complete Modu-Flo modular pumping package (MPP) includes a pump, a baseplate manifold, a reservoir, and a variety of optional accessories. For more details search for brochure L12000 on Graco.com.

### Fill Cap and Strainer

Included with every oil reservoir.

### Low Level Switch

Options available for both oil and grease reservoirs.

### High-Pressure Blowout Switch

Options for most oil and grease reservoirs; sold as a kit.

### Polycarbonate (Plastic) and Metal Reservoir Options

For oil or for grease, a total of 16 options are available (see page 69).

### Baseplate Manifold Kit

All plumbing connects to the manifold.

Option for use with NPT or BSP fittings.

Flapper valve inside works with modular pump design to allow removal and replacement of pump without draining lubricant from the reservoir.

### Modular Pump Design

With options for pneumatic or hydraulic (page 78), a total of six models are available.

Pneumatic pumps may have single or double action on their air motors, depending on which air solenoid is used to actuate the air motor.

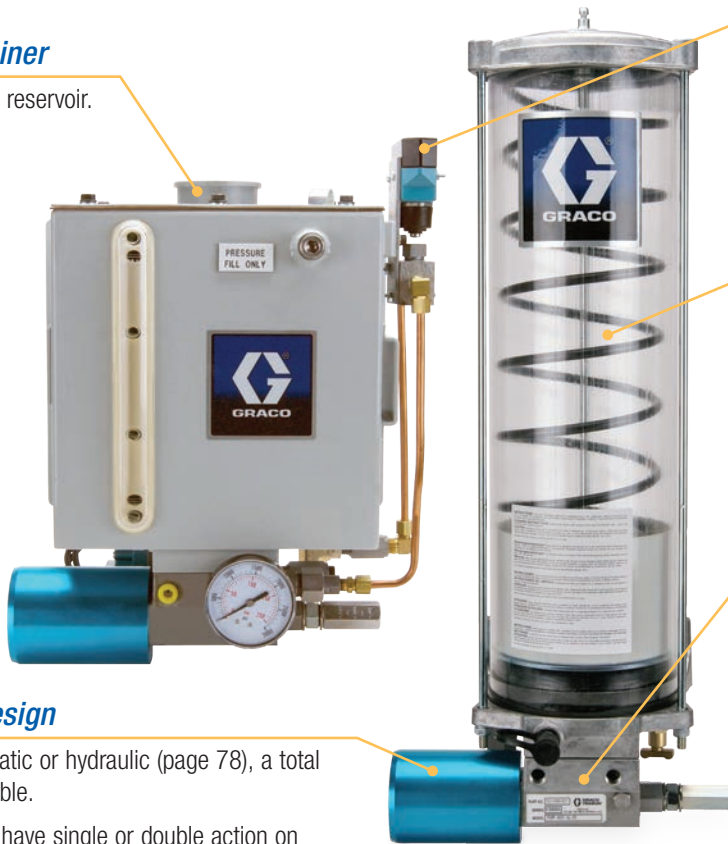

#### Pneumatic Pump Technical Specifications

Output per Stroke	0.010 to 0.240 in <sup>3</sup> (0.164 to 3.933 cm <sup>3</sup> )
Air Motor Action	Single or Double
Lube Piston Action	Single
Pump Ratio	30:1
Instruction Manual	332042

#### Typical Fluids

- Oil and grease up to NLGI #2

#### Typical Applications

- In-plant
- Presses
- Mixers

## Steps to Build Your Modu-Flo System:

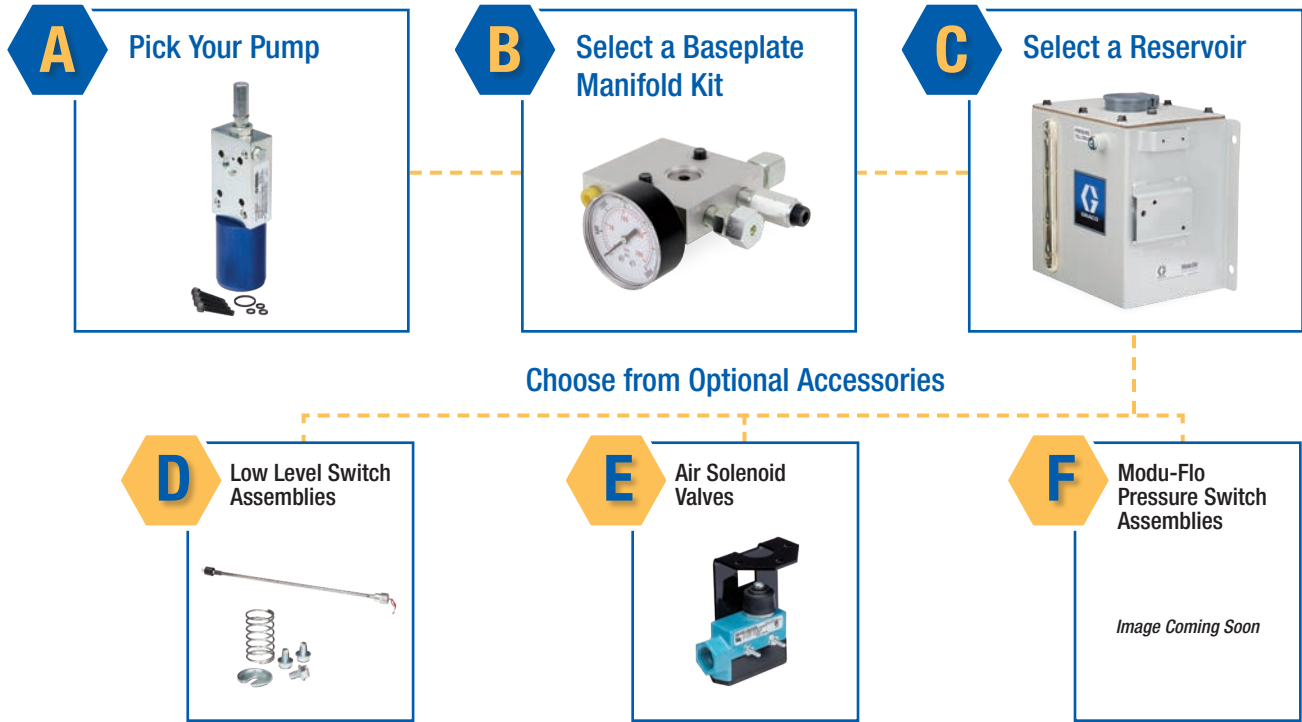

### Ordering Information

#### Modu-Flo Pneumatic Pumps

	Pump Part Number	Model	Pump Output Range per Stroke in <sup>3</sup> (cm <sup>3</sup> )	Air Motor Action	Maximum Cycles per Minute		Input Air Pressure Range PSI (bar)		Maximum Fluid Outlet Pressure PSI (bar)	Repair Kit Part Number
					Oil	Grease	Minimum	Maximum		
	563304	AL-5M	0.010 to 0.030 (0.164 to 0.492)	Single	30	10	40 (2.76)	150 (10.3)	3,000 (207)	563902
				Double*	60					
	563306	AL-25M	0.030 to 0.120 (0.492 to 1.966)	Single	30					
				Double*	60					
	563308	AL-50M	0.060 to 0.240 (0.983 to 3.933)	Single	30					
				Double*	60					

\*Double acting air motors require a 4-way air solenoid to create the "double action." Single acting use a 3-way air solenoid and rely on spring return.

Complete your Modu-Flo pump package with a Baseplate Manifold, Reservoir and Accessories from the next page or refer to bulletin L12000. When replacing an older pump such as ALS-3A, ALJ-25C, etc., refer to the "Remote" Pump Manifold options to allow wall-mounting of the new pump instead of mounting directly to bottom of a reservoir.

## A Ordering Information



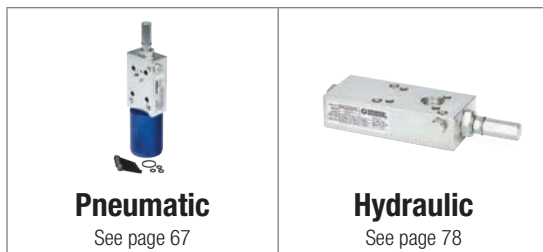

### Pick Your Modu-Flo Pump



## B Ordering Information

### Baseplate Manifold Kits

Note: 563324 and 563331 are the most popular kits.

	Part Number	Thread	Mount	Outlet Check Valve	System Fill Check Valve	1,450 psi Blowout Assembly	0-3,000 psi Gauge
	563329	NPSF (NPT)	Reservoir	No	No	None	None
	563324	NPSF (NPT)	Reservoir	Yes	Yes	Standard	Dry
	563331	NPSF (NPT)	Reservoir	Yes	Yes	Tubed**	Dry
	563333	NPSF (NPT)	Reservoir	Yes	Yes	Tubed**	Liquid-filled
	563336	NPSF (NPT)	Reservoir	Yes	Yes	Tubed**	None
	563323	NPSF (NPT)	Wall/Remote*	Yes	Yes	Standard	None
	563330	NPSF (NPT)	Wall/Remote*	Yes	Yes	Tubed**	None

\*Manifolds are intended for gravity feed (oil) or spring loaded follower feed (grease) only; not for use with header systems. \*\*Includes 1/8 in NPT female spud.

**C** Ordering Information

**Select a Reservoir**

Modu-Flo reservoirs include a built-in mounting bracket, and also a Pump Mounting Pad at the bottom of the reservoir. The pump mounting pad receives the "Reservoir" mount manifolds above (as well as several other pumps). The pad also includes a port with 1/2 in NPSF female thread to receive either an NPT or NPTF male fitting and then can then be used to gravity-feed a remote pump.

Part Number	Material	Capacity*	Tube and Gasket Replacement Kit
<b>Cylindrical Grease Reservoirs</b>			
562911	Plastic (Poly-carbonate)	3 pound	-
562888		5 pound	562901
562905		6 pound	562909
562884		12 pound	562902
562885		20 pound	562903
564264	Metal	5 pound	564269
562906		6 pound	-
562886		12 pound	564270
562887		20 pound	564271

<b>Cylindrical Oil Reservoirs</b>			
562891	Plastic (Poly-carbonate)	5 pint (2.4 L)	562901
562904		6 pint (2.8 L)	562909
562889		12 pint (5.7 L)	562902
562890		20 pint (9.5 L)	562903

<b>Rectangular Oil Tanks</b>			
563319	Metal	12 pint (5.7 L)	563934 oil level sight glass kit
563320		24 pint (11.4 L)	
563321		40 pint (18.9 L)	

\*Nominal grease reservoir size is based on a direct conversion of oil reservoir capacity and does not reflect volume loss due to the follower and spring. Actual volumes contained are:

Nominal Size	Actual Volume
3 lb	3 lb (1.5 L)
5 lb	
6 lb	
12 lb	6 lb (3 L)
20 lb	12 lb (6 L)

Pneumatic Pumps

**D** Ordering Information

**Low Level Switch Assemblies**

**For Grease Reservoirs**

3 lb	5, 6, 12 and 20 lb	Replacement Switch	Description
563272	563322	557781	SPDT switch and bracket kit installs to existing components included with grease reservoirs

**For Oil Reservoirs**

Cylindrical			Rectangular Metal Tanks	Replacement Switch	Description
5 and 12 Pint	20 Pint	6 Pint			
563015	563016	563014	563014	557825	"Low Watt" SPST switch assembly, used for most oils
563316	563317	563318	563318	557551	SPDT switch, older style preferred for heavy, stringy oils
-	-	-	564322	557825	Dual SPST, Low Watt Switches (One Low Level, One Shutdown)

**E** Ordering Information

**Air Solenoid Valves**

150 PSI maximum pressure, 1/4 in NPT female inlet.

Voltage			Air Outlet	Valve Ways	Air Motor Action	Valve Mounting
24 VDC	120 VAC	240 VAC				
563332	563315	–	1/4 in NPSF male banjo	3-way	Single	Baseplate Manifold
128254	128255	128257	1/4 in NPT female	4-way	Double	Wall

**F** Ordering Information

**Modu-Flo Pressure Switch Assemblies**

For Cylindrical Reservoirs		For Rectangular Metal Tanks	Replacement Switch	Description
5 Pint/Pound	6, 12 and 20 Pint/Pound			
563325*	563326*	563327	557781	High Pressure Blowout Switch Kit, requires approximately 3 ft of 1/4 in OD copper tubing, not included
563328*			557829	Kit includes Tee fitting for mounting to outlet port.

\*Kits include yellow disks for use in oil systems. For grease systems replace the yellow disk with a red or an orange disk, depending on pressure rating of your mainline grease hose/tubing.

**Spare or Replacement Blowout Disks**

For pressure relief.

psi (bar)	Color Code	Part Number	
		Single	6-Pack
1,450 (99.9)	Yellow	557433	563962
1,750 (120.7)	Red	557434	563963
2,050 (141.4)	Orange	557435	563964
2,350 (162.0)	Aluminum	557436	563965
2,650 (182.6)	Pink	557437	–
2,950 (203.0)	Blue	557438	563966
3,250 (220.1)	Purple	557439	–

\*Disks up to 2,350 psi have a tolerance of ± 500 psi. Disks greater than 2,350 psi have a tolerance of ± 20%.

**More Spare Parts for Modu-Flo Packages**

563337	Pump mounting kit, includes four mounting screws, one large O-ring and three small O-rings to connect any Modu-Flo pump to bottom of baseplate manifold. Kit is included with new pumps, sold here as a spare part.
--------	---

NPT Part Number	SAE-ORB Part Number	Description
563207	563053	Outlet Check Valve
563211	563056	System Fill Check Valve
563179	563180	Standard Blowout Assembly (1,450 psi / 100 bar)
563186	n/a	Tube Blowout Assembly (1,450 psi / 100 bar)
557864	n/a	Standard (Dry) Pressure Gauge, 0-3,000 psi/0-210 bar dual scale, center back mount.
557866	557280	Liquid-Filled Pressure Gauge, 0-3,000 psi/0-210 bar dual scale, center back mount (557280 is PSI scale only).

## Designed for Reliability

The E-Series pump is a minimum cost, entry level alternative to standard pneumatic pump products. This all-in-one pump package comes complete with no assembly required and is easy to install. All pump packages include high-pressure rupture disk assembly and lube outlet check valve. The E-Series offers many reservoir options for either grease or oil. Great for any application where price is a concern and installation time is at a premium.

### Modu-Flo Reservoirs

Provides easy interchangeability plus compatibility to most Modu-Flo accessories.

### Two Pump Options

Choose from the original fixed output pump or the adjustable output version.



### Standard Low Level Switch Options

Uses the same switch kits as many other Trabon® pumps.

### Drain Valve

Included petcock acts as a grease drain before removing a pump, and an air bleed during initial filling.

### Technical Specifications

Output per Stroke	0.010 to 0.030 in <sup>3</sup> (0.164 to 0.492 cm <sup>3</sup> )
Max Output Pressure	2,000 psi (138 bar)
Ratio	20:1
Reservoir Material	Plastic, cylindrical or rectangular
Air Pressure	40 to 150 psi (2.8 to 10.3 bar)
Cycle Rate	10 CPM grease, 30 CPM oil
Instruction Manual	L13126

### Typical Fluids

- Oil up to 30,000 SUS
- Grease up to NLGI #2

### Typical Applications

- Presses and other in-plant machines

## Ordering Information

### E-Series Pump Packages

Low Level Option		Reservoir Size	Pump Output	Relief Valve psi (bar)	Low Level Switch
Included	Not Included				
<b>Grease Packages</b>					
–	563365	3 lb	Fixed	2,000 (138)	563272
563360	–	5 lb	Fixed	1,750 (121)	563322
563364	563363	6 lb	Fixed	2,350 (162)	
–	563370	6 lb	Adjustable	2,000 (138)	
–	24N776	12 lb	Fixed	2,350 (162)	

### EZ Greaser / Grease Jockey Trailer Pump Packages

For fluid grease only (NLGI #0-000)

–	563368	4 lb	Adjustable	Not Included	–
–	563372	10 lb	Adjustable	Not Included	–

### E-Series Bare Pumps

Part Number	Pump Output	Pump Output Range per Stroke in <sup>3</sup> (cm <sup>3</sup> )	Relief Valve psi (bar)	Repair Kit
563358	Fixed	0.030 (0.492)	1,750 (121)	563909
563367	Adjustable	0.010 to 0.030 (0.164 to 0.492)	Not Included	563945

### Air Solenoid Valves

150 psi maximum pressure, 1/4 in NPT female inlet

Voltage		Air Outlet	Valve Ways	Air Motor Action
24 VDC	120 VAC			
563332	563315	1/4 in NPSF male banjo	3-way	Single

To create your own custom pump package, combine either of the pump options above with any Modu-Flo reservoir listed on page 69.

**Durable In-Line Pumps**

MSA Series pumps are used together with main lubrication supply lines where the pump is fed directly from a bulk header system. MSA pumps can also be piped to Modu-Flo reservoirs. Use the MSA-10 for standard applications and the MSA-100 when larger outputs are required.



Pneumatic Pumps

Technical Specifications		
	MSA-10	MSA-100
Material	Steel	Aluminum
Output per Stroke	0.04 to .120 in <sup>3</sup> (0.66 to 1.97 cm <sup>3</sup> )	0.4 to 0.8 in <sup>3</sup> (6.57 to 13.11 cm <sup>3</sup> )
Maximum Pump Strokes per Minute	Single-Acting – 15 Double-Acting – 60	Single-Acting – 15 Double-Acting – 30
Maximum Output Pressure	3,000 psi (207 bar)	
Air Pressure	40 to 150 psi (2.8 to 10.3 bar)	60 to 140 psi (4.1 to 9.7 bar)
Maximum Lube Inlet Pressure	500 psi (34 bar)	
Pump Ratio	25:1	
Instruction Manual	L12850	L12851

**Typical Fluids**

- Oil and grease up to NLGI #2



**Typical Applications**

- Presses and other in-plant machines and processing equipment



# MSA-10 and MSA-100

## Ordering Information

### MSA Pumps

	Part Number	Description
	562854	MSA-10 Air Operated Pump
	562855	MSA-100 Air Operated Pump

### MSA Kits

	Part Number	Description
	563912	MSA-10 Repair Parts Kit
	563913	MSA-100 Repair Parts Kit

### Restrictor Valve

	Part Number	Description
	563072	Slows the power stroke of the pump while allowing full speed on the return stroke.

### Relief Assembly Replacement Parts

Part Number	Description
557402	Blowout disk retaining nut with 1/4 in orifice
560701	Relief adapter body for MSA-10 pump
15R130	Relief adapter body for MSA-100 pump
557433	Yellow blowout disk, 1,450 psi (100 bar)
563962	Yellow blowout disk, 6 pack

See page 70 for full list of blowout disk options.

## Simply Legendary

Dyna-Star pump modules offer positive displacement lubrication for multiple lubrication points. At the heart of this system is the Graco Fire-Ball® pump, the most durable pump in the industry. The entire system consists of a pump module, injectors and system controls. The pump module provides the system inherent pressurization and venting cycles to actuate and reset the injectors.

### Reciprocating Air Motor

Continuously pumps grease as long as air is supplied to it, until it stalls against system pressure.

### Strong 12-Gauge Steel Reservoir

Available in 60 lb (27 kg) or 90 lb (41 kg) reservoirs. Matches common bolt pattern.



### Fire-Ball 300 50:1 Grease Pump

Provides the lubricant pressure needed to activate the automatic lubrication system.

### Vent Valve

Opens a return path to the reservoir between lubrication cycles, allowing the injectors to reset. Includes 4,000 psi (276 bar) relief valve.

### Technical Specifications

Maximum Output Flow Rate	54 in <sup>3</sup> /min (885 cm <sup>3</sup> ) at 60 PSI (4.1 bar) air
Maximum Recommended Pump Speed	76 cycles/min at 0.22 gpm (0.82 liter/min)
Ratio	60:1 theoretical, 50:1 common
Air pressure Operating Range	50 to 60 PSI (3.4 to 4.1 bar)
Air Inlet	3/8 in NPT on pump, 1/4 in NPT on module
Maximum Fluid Output Pressure	8,400 psi (580 bar) bare pump, 3,500 psi (241 bar) with vent valve
Fluid Output Thread	1/4 in NPT on pump, 1/2 in NPSM female on module
Instruction Manual	308955 / 308883

### Typical Fluids

- Oil and grease up to NLGI #2

### Typical Applications

- Energy, Infrastructure and Heavy Equipment
- In-Plant Manufacturing

# Pneumatic Dyna-Star® Fire-Ball® 300 50:1

## Ordering Information

### Pneumatic Dyna-Star Injector System Modules



Modules ship fully assembled, complete with vent valve and hydraulic fluid controls. See below for follower plate options (AFSO is not compatible with follower plate).

Part Number	Reservoir Size	Replacement Reservoir	Replacement Pump	Pump Repair Kits	
				Air Motor	Pump Lower
25D096	60 lb (27 kg)	247575	239877	206728	241623
241573	90 lb (41 kg)	241486	239887		

### Module Accessories

	Part Number	Description
	215407	Air Solenoid – 150 PSI (10 bar) max, 24 VDC or 120 VAC , 1/4 in NPT with 3/8 in NPT adaptors.
<i>Image Coming Soon</i>	114488	Air Solenoid – 150 PSI (10 bar) max, 24 VDC only, 3/8 in NPT ports.
	109075	3/8 in NPT air regulator with gauge
	110150	FRL combo kit – includes air filter, regulator, pressure gauge, lubricator and connection fittings
	241485	Follower plate
	77X522	Low level switch kit – requires follower plate
	241572	Vent Valve Kit – included with packages 25D096 and 241573
	115122	Replacement Relief Valve – 4,000 psi (276 bar) relief pressure
	115124	Pressure switch – pressure adjustment visible in window
	24N181	Pressure switch – 1/4 in NPT(F) inlet, DIN connector (1 NO/1 NC), 7,250 psi (500 bar)

# Hydraulic Pump Selection Guide

Pump Family	Typical Applications	Fluid Type	Maximum Output Pressure psi (bar)	Maximum Output Volume in <sup>3</sup> (cm <sup>3</sup> )	Reservoir Capacity Options		Metering	Reference Page
					US	Metric – Liters		
<b>Modu-Flo®</b> 	<ul style="list-style-type: none"> <li>• Energy, Infrastructure and Heavy Equipment</li> <li>• In-Plant Manufacturing</li> </ul>	Oil/grease up to NLGI #2	3,000 (207)	0.12 (1.97) per stroke	Oil – 5, 6, 12, 20, 24 or 40 pints Grease* – 3, 6 or 12 lbs	Oil – 2.4, 2.8, 5.5, 9, 11 or 19 Grease – 1.5, 3 or 6	SLP	78
<b>Hydraulic Dyna-Star® 10:1 and 5:1</b> 	<ul style="list-style-type: none"> <li>• Energy, Infrastructure and Heavy Equipment</li> <li>• In-Plant Manufacturing</li> </ul>	Oil/grease up to NLGI #2	7,500 (517)	36 (590) per minute	60 or 90 lb reservoir  or standard barrel length options	30 or 45 L reservoir	SPDV or SLP	79-82

\*See page 39 for note on legacy Trabon grease reservoir volumes and metric conversions.

 = Single Line Parallel (Injectors)    
  = Series Progressive Divider Valve

## True Modularity

Wide choice of standard modular components helps you meet application requirements more exactly without the added cost of a custom system. A complete Modu-Flo modular pumping package (MPP) includes a pump, a baseplate manifold, a reservoir and a variety of optional accessories. For more details, refer to brochure L12000 on Graco.com.

### Polycarbonate (Plastic) And Metal Reservoir Options (not shown)

For oil or for grease, a total of 16 options are available. (See page 69).

### Baseplate Manifold Kit (not shown)

- All plumbing connects to the manifold.
- Options for use with NPT or BSP fittings. (See page 177).
- Flapper valve inside works with modular pump design to allow removal and replacement of pump without draining lubricant from the reservoir.



### Modular Pump Design

With options for pneumatic (page 67) or hydraulic power, a total of six models are available. Hydraulic pumps all utilize double-acting hydraulic motors (not reciprocating).

### Adjustable Output

Permits a broad range of applications.

#### Technical Specifications

Output per Stroke	0.010 in <sup>3</sup> to 0.120 in <sup>3</sup> (0.164 cm <sup>3</sup> to 1.966 cm <sup>3</sup> )
Hydraulic Motor Action	Double
Lube Piston Action	Single
Instruction Manual	332042

#### Typical Fluids

- Oil and grease up to NLGI #2

#### Typical Applications

- In-plant
- Presses
- Mixers

## Ordering Information

### Modu-Flo Pumps

Pump Part Number	Model	Pump Ratio	Pump Output Range per Stroke in <sup>3</sup> (cm <sup>3</sup> )	Maximum Cycles per Minute		Input Hydraulic Pressure Range PSI (bar)		Maximum Fluid Outlet Pressure PSI (bar)	Repair Kit Part Number
				Oil	Grease	Minimum	Maximum		
563305	HLJ-5M	5.5:1	0.010 to 0.030 (0.164 to 0.492)	60	10	200 (13.8)	2,000 (138)	3,000 (207)	563905
563307	HLJ-25M		0.030 to 0.120 (0.492 to 1.966)	50					563906
563345	HLJ-5X	2.2:1	0.030 to 0.092 (0.492 to 1.508)	50					3,000 (207)

Complete your Modu-Flo pump package with a Baseplate Manifold, Reservoir, and Accessories from the Pneumatic Modu-Flo Pump Section on page 67, or refer to bulletin L12000. When replacing an older pump such as HLJ-5A, HLJ-25A, etc., refer to the "Remote" Pump Manifold options to allow wall-mounting of the new pump, instead of mounting directly to bottom of a reservoir.

## Field Proven, Energy Efficient

Hydraulic Dyna-Star pumps provide reliable, quiet, ice-free performance at maximum pressure and low flow rates and are up to three times more energy efficient than comparable compressed-air systems.

### High-Efficiency Motor Design

Uses less hydraulic oil.

### 10:1 Ratio For Lower Hydraulic Pressure

Full pressure performance by safely tapping low pressure hydraulics.

### Quiet Hydraulic Motor

No need for add-on mufflers.

### Self-Lubricating Vertical Design

For long life and reliable operation in high vibration environments.

### Multiple Pump And Accessory Options

For use with refinery drum and custom tank installations.



### Technical Specifications

Maximum Hydraulic Fluid Input Volume	3 gpm (11 lpm)
Maximum Output Flow Rate	36 in <sup>3</sup> (0.59 l)/min
Maximum Cycles per Minute	60
Hydraulic Supply Inlet	3/4 in -16 JIC-8 (37° flare) male
Hydraulic Return Outlet	3/4 in NPT
Incoming Hydraulic Fluid Maximum Temperature	200°F (93°C)
Maximum Fluid Output Pressure	7,500 psi (517 bar)*
Maximum Hydraulic Input Pressure	600 psi (41 bar)
Fluid Outlet Thread	1/2 in NPT female
Instruction Manual	312350

\*When used in an injector system, the vent valve limits maximum to 3,500 psi (241 bar).

### Typical Fluids

- Oil and grease up to NLGI #2

### Typical Applications

- Energy, Infrastructure and Heavy Equipment
- In-Plant Manufacturing

## Ordering Information

### Hydraulic Dyna-Star Pumps

Part Number	Description	Container Size	Overall Pump Length	Pump Lower Length
2008088	Dyna-Star 10:1, 60 lb (27 kg) pump*	60 lb (27 kg)*	33.9 in (861 mm)	19.15 in (501 mm)
247443	Dyna-Star 10:1, 90/120 lb (41/55 kg) pump*	90/120 lb (41/55 kg)*	41.5 in (1,054 mm)	26.75 in (679 mm)
247450	Dyna-Star 10:1, 400 lb (180 kg) pump	400 lb (180 kg)	48.5 in (1,232 mm)	33.75 in (857 mm)

\*Used in Graco 60 or 90 lb (27 or 41 kg) reservoirs.

### Hydraulic Pump Injector System Modules

Modules ship fully assembled, complete with vent valve and hydraulic fluid controls. See below for follower plate options (AFSO is not compatible with follower plate).

Part Number		Pump Ratio	Low Level 17L372 (M12)	Auto-Fill Shut Off (AFSO)	Instruction Manual
Reservoir Size					
60 lb (27 kg)	90 lb (41 kg)				
–	243159*	5:1*			309098
247574	247444	10:1			312349
24Y408	24Y407			•	3A3429
25C948	25C949		•	•	

\*5:1 pump is normally used to replace existing pumps with the same or similar ratio. For new applications use 10:1 pumps.

### Hydraulic Pump Packages

Packages are kits with popular components included in one part number. Some assembly required.

Module Part Number	Series Progressive System or Bulk Fluid Dispensing		Injector Pump Kits, without Reservoir – Mount to existing reservoir or refinery drum				
	247706	247707	26C537	26C538	26C539	26C144	26A325
Container Size	60 lb (27 kg)	90 lb (41 kg)	60 lb (27 kg)	90/120 lb (41/55 kg)	400 lb (180 kg)	120 lb (55 kg)	400 lb (180 kg)
Pump Ratio	10:1		10:1			10:1	
Bare Pump Part Number	2008088	247443	2008088	247443	247450	247443	247450
Reservoir Assembly	247575	241486	–			–	
Hydraulic Control Assembly	247538	247538	247538	247538	247538	247538	247538
Follower Plate	–		–			247701	247702
Drum Cover	–		–			247703	247704
Low Level Switch Kit	–		–				77X522
Manual Pressure Relief Kit	247902	247902	–			–	
Pump Mounting Gasket	–		15M442	15M442	15M442	15M442	15M442
Vent Valve Kit	–		243170	243170	243170	243170	243170
Instruction Manual	312349		–			–	

» Ordering Information

**Reservoir Assemblies**









Part Number		Description
Container Size		
60 lb (27 kg)	90 lb (41 kg)	
247575	241486	Standard Dyna-Star Reservoir complete with cover
25C950	25C951	Bare Dyna-Star Reservoir with side port for Low Level Switch, no cover. Use to add LL sensor to an existing module. Sensor 17L372 sold separately.

**Follower Plates and Drum Covers for 10:1 Pumps**

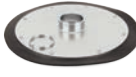
Part Number			Description
Container Size			
60/90 lb* Graco reservoir	120 lb refinery drum	400 lb refinery drum	
247700	247701	247702	Follower Plate
–	247703	247704	Drum Cover

\*Follower plate can not be used with AFSSO option.

**Accessories and Replacement Parts**

	Part Number	Description
	15M442	Pump mounting gasket
	243170	Vent valve kit
	247538	Hydraulic control module
	243191	Follower plate for 60 or 90 lb reservoir with 5:1 pump
	244023	Level indicator for 60 lb and 90 lb modules, cover-mount, with flying leads*
	77X522	Level indicator for 60 lb and 90 lb modules, cover-mount, with DIN connector*
<i>Image Coming Soon</i>	17L372	Low level switch for AFSSO modules that include side port for switch
	115124	Pressure switch – pressure adjustment visible in window
	24N181	Pressure switch, 1/4 in NPT(F) inlet, DIN connector (1 NO/1 NC), 7,250 psi (500 bar)
	247902	Manual pressure relief (dump valve) kit for 247706 and 247707

\*Cover-mount low level switches require follower plate (sold separately). Not Compatible with AFSSO option.

# High-Pressure 10:1 Hydraulic Dyna-Star®

## 10,000 psi (689 bar) Hydraulic Lubrication Pump for 120 lb (55 kg) Kegs

High Pressure Pump and Reciprocator used for dispensing grease in wireline applications for oil well services.

### Dyna-Star® Hydraulic Reciprocator

Time proven, Graco quality.

### Self-Lubricating Vertical Design

For long life and reliable operation in high-vibration environments.

### Pump Lower

Specially designed for the high pressure required for wireline lubrication.

### Outlet Port

13/16-16 UNC thread in pump body, ships with 1/2 NPT adapter included.

### Pump Shovel

Helps feed grease into the pump.



### Technical Specifications

Maximum Hydraulic Fluid Input Volume	3 gpm (11 lpm)
Maximum Output Flow Rate	1.1 lb/min (0.5 kg/min)
Maximum Cycles per Minute	60
Hydraulic Supply Inlet	3/4 in -16 JIC-8 (37° flare) male
Hydraulic Return Outlet	3/4 in NPT
Incoming Hydraulic Fluid Maximum Temperature	200°F (93°C)
Container Size	120 lb (55 kg)
Overall Pump Length	41.5 in (1054 mm)
Pump Lower Length	26.75 in (679 mm)
Maximum Fluid Output Pressure	10,000 PSI (689 Bar)
Maximum Hydraulic Input Pressure	900 PSI (62 Bar)
Fluid Outlet Thread	13/16 in -16 UNC female
Instruction Manual	3A3005

### Typical Fluids

- Oil and grease up to NLGI #2

### Typical Applications



- Wireline lubrication
- Wellhead gate valve and plug valve greasing

### Ordering Information

#### High-Pressure Hydraulic Dyna-Star® Pump

Part Number	Description
25A189	Dyna-Star 10:1, 120 lb (55 kg) pump

# Mechanical Pump Selection Guide

Pump Family	Typical Applications	Fluid Type	Maximum Output Pressure psi (bar)	Maximum Output Volume per Stroke in <sup>3</sup> (cm <sup>3</sup> )	Reservoir Capacity Options		Metering	Reference Page
					US	Metric - Liters		
<b>Lube Master®</b> 	<ul style="list-style-type: none"> <li>In-Plant Manufacturing</li> </ul>	Oil/grease up to NLGI #2	5,000 (345)	Direct Drive – 8.6 (143) Clutch Drive – 1.25 (20) per minute	Oil – 12 or 20 pint Grease* – 6 or 12 lb	Oil – 5.5 or 9 Grease – 3 or 6	SPDV	84-86
<b>Manzel® MBL®</b> 	<ul style="list-style-type: none"> <li>Energy, Infrastructure and Heavy Equipment</li> </ul>	Oil – 80 to 5,000 SUS	7,500 (517)	2.7 (44) per element, per minute, adjustable Up to 24 pump elements	4, 6, 8, 12, 16, 24, 32 or 40 pint	1.9, 2.8, 3.8, 5.7, 7.6, 11, 15 or 19	SPDV or PtP	87-90

\*See page 79 for note on grease reservoir volumes and the metric weight conversions.



SPDV = Series Progressive Divider Valve



PtP = Pump to Point

# Lube Master® Ratchet Drive Pump

## Rugged and Reliable

Lubricates only while the machine is running! The Lube Master Clutch Drive is a rugged, reliable pump powered mechanically by the machine using the lubrication. This pump is ideal for applications where lubrication cycles vary and are unpredictable.

### Low Level Switch Options

Available for both oil and grease reservoirs.

### Reservoir Options

For oil or grease, 12 or 20 pint/pound, plastic or metal.

### Direct or Clutch Drive

Direct Drive provides shaft to receive a pulley or sprocket; Clutch Drive functions like a ratchet arm to be driven linearly.

### Adjustable Pump Displacement

Set the pump output with the turn of a wrench.



Mechanical Pumps

## Technical Specifications

Output Per Pump Stroke	0.010 to 0.050 in <sup>3</sup> (0.164 to 0.819 cm <sup>3</sup> )
Maximum Output Pressure	5,000 psi (340 bar)
Maximum Torque at Rated Maximum Pressure	27 ft lbs (36.6 N-m)
Reservoir Size	Oil – 12 pint or 20 pint / Grease – 12 lb or 20 lb
Reservoir Material	Plastic (polycarbonate) or metal, cylindrical
Instruction Manual	3A2781

## Typical Fluids

- Oil and Grease up to NLGI #2

## Typical Applications

- In-plant – presses, Banbury mixers, rubber mills, upsetters, heading machines, crane trolleys, chains, conveyors

## Direct Drive

Pump Output Ranges	RPM at Drive shaft	Pump Strokes per Minute	Output per Minute in <sup>3</sup> (cm <sup>3</sup> )	
			Minimum	Maximum
Minimum	1	1	0.01 (1.64)	0.05 (8.20)
Maximum	175	175	1.75 (28.7)	8.75 (143.3)

## Clutch Drive

Pump Output Ranges	Degree of Throw	Impulses per Minute	Pump Strokes per Hour	Output per Hour in <sup>3</sup> (cm <sup>3</sup> )	
				Minimum	Maximum
Minimum	12	5	10	0.1 (1.64)	0.5 (8.19)
Maximum	60	150	1,500	15 (246)	75 (1,229)

## Ordering Information

### Popular Lube Master Assembly Models



Pressure Gauge 2007096 is included with every LMxxxx assembly.

With Low Level Switch	Without Low Level Switch	Reservoir		Drive Type
		Material	Capacity	
<b>Grease Packages</b>				
LM5114	LM5111	Plastic	12 pound	Direct drive, shaft only
LM5214	LM5211		20 pound	Clutch drive with ratchet arm
LM6214	LM6211		12 pound	
LM7214	LM7211	Metal	12 pound	Direct drive, shaft only
LM8114	LM8111		20 pound	
LM8214	LM8211			
<b>Oil Packages</b>				
LM1115	LM1111	Plastic	12 pint	Direct drive, shaft only
LM1215	LM1211		20 pint	Clutch drive with ratchet arm
LM4215	LM4211			

See page 38-41 for a complete Lube Master ordering menu.



### Accessories

#### Pressure Indicators

	Grease – Aluminum-colored disk, 2,350 PSI (162 bar)	Oil – Yellow-colored disk, 1,450 PSI (100 bar)	Description
	563184	563179	Standard blowout fitting
	563385	563384	High-pressure blowout switch kit*
	563965	563962	Package of 6 blowout disks

\*Each kit requires approximately 3 ft of 1/4 in OD copper tubing, not included.



#### Low Level Switches – Grease

	Part Number	Description
	563322	Standard SPDT, 15 amp switch kit, mounts to top of all grease reservoirs
	564318	High/low level switch kit, for metal grease reservoirs only
	564377	Explosion-proof low-level switch for grease reservoirs. (Class I, Group C and D; Class II, Group E, F and G)

# Lube Master® Ratchet Drive Pump

## Ordering Information

### Low Level Switches – Oil

	12 Pint	20 Pint	Description
	563015	563016	SPST, 10 watt, most popular option
	563316	563317	SPDT, 15 amp, for use with heavy or stringy oils

### Spare Parts

	Part Number	Description
	563383	Replacement clutch drive with ratchet arm

See pages 38-41 for accessories, repair kits and other spare parts.

## Force Feed Box Lubricators

The Manzel® Modular Box Lubricator (MBL) provides true modularity that permits customizing a pump-to-point lubrication systems from off-shelf components. MBL pumping packages can also be used with MHH divider valves in a series progressive system. Each moving part is lubricated at all times by the fluid in the reservoir. This and the wide range of options, high discharge pressure and rugged construction make the MBL ideally suited for a wide variety of industries and applications.

### GBL 7500 Pumps

Modern design that has become the industry standard. See page 55 for pump part numbers.

### Suction Pumps Installed

Use ordering menu on page 55 to specify pumps to be installed. Gravity and pressure feed pumps are sold separately for field installation.

### Modular Drive

External drive assemblies available as replacement parts.



### Heater Port

Integrated 1 in NPT port makes optional electric heater installation simple.

### Heavy Steel Reservoirs

Eight reservoir capacities are available to hold up to 40 pints and 24 pumps.

### Technical Specifications

Maximum Pressure	7,500 psi (517 bar)
Operating Temperature	-20°F to 140°F (-29°C to 60°C)
Reservoir Size	See the following pages
Maximum Run Time	Continuous
Output per Element/Min	0.7, 1.2 or 2.7 in <sup>3</sup> (11.45, 19.65 or 44.25 cm <sup>3</sup> )
Certifications/Standards	ATEX (depending on configuration)
Instruction Manual	3A2100

### Typical Fluids

- Mineral oil base or synthetics
- 80 to 5,000 SUS

### Typical Applications

- Compressors – petrochemical, refineries, gas transmission and more
- Edgers, planers and band saws
- Rubber mixers
- Cannery lid presses

# Manzel® MBL Pump/Reservoir Combinations Without Pumps

## Ordering Information

### Direct Drives

1:1 ratio means the camshaft turns at the same speed as the drive shaft. Maximum input speed 50 RPM.

	Reservoir Size							
	4 pint (1.9 L), 2 feed	6 pint (2.8 L), 3 feed	8 pint (3.8 L), 5 feed	12 pint (5.7 L), 8 feed	16 pint (7.6 L), 12 feed	24 pint (11 L), 16 feed	32 pint (15 L), 20 feed	40 pint (19 L), 24 feed
Right Hand End	MBA0AA	MBB0AA	MBC0AA	MBD0AA	MBE0AA	MBF0AA	MBG0AA	MBH0AA
Left Hand End	MBA0AE	MBB0AE	MBC0AE	MBD0AE	MBE0AE	MBF0AE	MBG0AE	MBH0AE
Replacement Camshaft	564173	564174	564178	564182	560387	560388	560389	560390

### MBL Direct Drive With Thru Shaft

Cam shaft protrudes from both right and left hand end of reservoir. Each end includes a #5 woodruff keyway on 5/8 in (15.9 mm) diameter shaft. Typically used when a pump-to-point system requires multiple oils/lubricants. As with other MBL assemblies, each pump station includes a single lobe cam.

	Reservoir Size			
	12 pint (5.7 L), 8 feed	16 pint (7.6 L), 12 feed	24 pint (11 L), 16 feed	32 pint (15 L), 20 feed
Reservoir and Shaft Combo	26A159	564290	25N624	26A172
Replacement Camshaft	561371	561370	560392	17M153

### Ratchet Arm Drives

Driven by mechanical power via the ratchet arm\*.

	Reservoir Size							
	4 pint (1.9 L), 2 feed	6 pint (2.8 L), 3 feed	8 pint (3.8 L), 5 feed	12 pint (5.7 L), 8 feed	16 pint (7.6 L), 12 feed	24 pint (11 L), 16 feed	32 pint (15 L), 20 feed	40 pint (19 L), 24 feed
Right Hand End	MBA0AB	MBB0AB	MBC0AB	MBD0AB	MBE0AB	MBF0AB	MBG0AB	MBH0AB
Left Hand End	MBA0AF	MBB0AF	MBC0AF	MBD0AF	MBE0AF	MBF0AF	MBG0AF	MBH0AF
Replacement Camshaft	564166	564167	564170	560381	564179	560384	564186	564196

\*Ratchet arm 563005 sold separately.

### Rotary Ratchet Drives

Maximum input speed 800 RPM.

	Drive Ratio	Reservoir Size		
		4 pint (1.9 L), 2 feed	6 pint (2.8 L), 3 feed	8 pint (3.8 L), 5 feed
Right Hand End	37.5:1	MBA0AC	MBB0AC	MBC0AC
Left Hand End		MBA0AG	MBB0AG	MBC0AG
Right Hand End	75:1	MBA0AD	MBB0AD	MBC0AD
Left Hand End		MBA0AH	MBB0AH	MBC0AH
Replacement Camshaft		564168	564171	564172

## Ordering Information

### End Rotary Drives

Offered for Right Hand End only.

Drive Ratio	Reservoir Size				
	4 pint (1.9 L), 2 feed	6 pint (2.8 L), 3 feed	8 pint (3.8 L), 5 feed	12 pint (5.7 L), 8 feed	16 pint (7.6 L), 12 feed
25:1	MBA0AJ	MBB0AJ	MBC0AJ	MBD0AJ	MBE0AJ
50:1	MBA0AK	MBB0AK	MBC0AK	MBD0AK	MBE0AK
100:1	MBA0AL	MBB0AL	MBC0AL	MBD0AL	MBE0AL
200:1	MBA0AM	MBB0AM	MBC0AM	MBD0AM	MBE0AM
400:1	MBA0AN	MBB0AN	MBC0AN	MBD0AN	MBE0AN
Replacement Camshaft	564166	564167	564170	560381	564179

### Accessories

Part Number	Description
563005	Ratchet arm required for drives "B" and "F"
559037	Gravity Supply Auto-Fill Valve, for use with overhead day tank (refer to Modu-Flo oil tanks for options)
564015	Basic Low Level Switch – Single-pole, single-throw. 10 watts @ 120 VAC.
563013	Explosion Proof Low Level Switch – Single-pole, double-throw. Class 1 Group C and D requirements. Class 2 Group E, F and G requirements.
25T989	Cam replacement kit – includes cam, key, and set screw for one pump station. <i>For replacement cam shafts, see tables above.</i>

See page 185-186 for a complete MBL ordering menu and more accessories.

# Manzel® MB Specialty Box Lubricators

## Long Life and Durability

Leak-proof welded steel reservoir and solid steel, hardened cams. Double-supported cam shafts and gear drives to eliminate cantilevered assemblies and high load capacity needle bearings and ball bearings.

### MB118 Box Lubricators

- “Model 55” 118:1 reduction drive
- 4 or 6 pump stations max, use with any GBL 7500 pumps
- Maximum input speed 1,800 rpm
- Instruction Manual number 3A3006

### MB60 Box Lubricators

- Rear 60:1 reduction drive
- Perfect for bolt-on gas compressor box lubrication solutions
- 2 or 4 pump stations max, use with gravity-fed or pressure-fed GBL 7500 pumps
- Maximum input speed 1,800 rpm
- Instruction Manual numbers 3A2953, 334210



24W636

24V068

Mechanical Pumps

## Ordering Information

### MB118 Box Lubricators

#### 4 Pint (1.9 L), 4 Pump Capacity

For triplex mud pumps

Drive End		GBL 7500 Pumps*		Maximum Output Pressure
Left Hand	Right Hand	Quantity	Size	
25R513	24W633	0	N/A	N/A
25R557	24W636	3	1/4 in	6,000 psi (414 bar)

#### 6 Pint (2.8 L), 6 Pump Capacity

For quintuplex mud pumps

Right Hand Drive End	GBL 7500 Pumps*		Maximum Output Pressure
	Quantity	Size	
24W634	0	N/A	N/A
24W635	5	1/4 in	6,000 psi (414 bar)

### MB60 Box Lubricators

#### 2 Pint (0.95 L), 2 Pump Capacity

Left Rear Drive

Mount Orientation		GBL 7500 Pumps*	
Floor	Wall	Quantity	Size
24V068	25A071	0	N/A



#### 6 Pint (2.8 L), 4 Pump Capacity

Center Rear Drive

Drive Shaft		GBL 7500 Pumps*	
Keyway	Tang	Quantity	Size
24U750	24N724	0	N/A

\*See page 228 for GBL 7500 part numbers and more tech specs, including metric conversions.

# Manual Pump Selection Guide

Pump Family	Typical Applications	Fluid Type	Maximum Output Pressure psi (bar)	Maximum Output Volume per Stroke in <sup>3</sup> (cm <sup>3</sup> )	Reservoir Capacity Options		Metering	Reference Page
					US	Metric - Liters		
<b>PH Pump</b> 	<ul style="list-style-type: none"> <li>In-Plant Manufacturing</li> </ul>	Oil/grease up to NLGI #2	3,000 (207)	0.15 (2.5)	Oil – 5, 6, 12, 20, 24 or 40 pint Grease* – 3, 6, or 12 lbs	Oil – 2.4, 2.8, 5.5, 9, 11 or 19 Grease – 1.5, 3 or 6	SPDV	92-93
<b>LubriSystem</b> 	<ul style="list-style-type: none"> <li>In-Plant Manufacturing</li> </ul>	Oil/grease up to NLGI #1	3,000 (207)	0.125 (2)	Oil – 5, 6, 12, 20, 24 or 40 pint Grease* – 3, 6, or 12 lbs	Oil – 2.4, 2.8, 5.5, 9, 11 or 19 Grease – 1.5, 3 or 6	SLP	94

\*See page 69 for note on legacy Trabon grease reservoir volumes and metric conversions.



SLP = Single Line Parallel (Injectors)



SPDV = Series Progressive Divider Valve

## Versatile and Tough

Built with aluminum and steel components to meet the high standards of performance and quality you expect from Graco products. Available with a choice of standard clear plastic or metal Modu-Flo reservoirs for either oil or grease. Modular pump/reservoir design plus built-in features enable the PH Manual Pump to be customized for a wide range of applications.

### Single-Acting Positive Displacement Pump Design

Minimizes the number of moving and wearing parts for extended pump life and reduced maintenance.

### Pressure Relief Valve

Protects system components from over-pressure.



Pump 563393 shown with 5 lb grease reservoir 562888.

### Built-In Outlet Check Valve

Prevents back pressure from damaging pump and minimizes chance for contaminants to get into the pump or the lube supply.

### Built-In Volume Indicator

Provides easy verification that lubricant is being delivered to the system and that divider valves are completing lube cycles.

### Technical Specifications

Pump Output	0.15 in <sup>3</sup> (2.46 cm <sup>3</sup> ) per full stroke
Maximum Operating Pressure	3,000 psi (207 bar)
High Pressure Protection Relief Valve	Set @ 2,500 psi (172 bar)
Force to Operate Handle	29 lb (13.14 kg) per 1,000 psi (69 bar) @ rated pressure
Instruction Manual	L12415

### Typical Fluids

- Oil and Grease up to NLGI #2

### Typical Applications





- In-plant
- Mobile Equipment with an installed EZ-Greaser centralized lubrication system.

## Ordering Information

### PH Pump

	Part Number	Description
	563393	PH Pump (without reservoir). Pressure gauge 557864 included.

### Replacement Parts

	Part Number	Description
	557864	3,000 PSI / 210 bar dual scale pressure gauge
	563160	Pressure relief valve, 2,500 psi (172 bar)
	558906	Mating coupler for grease fill stud
	563924	PH Pump Repair Kit

### Reservoir Options

To create your own custom pump package, combine pump 563393 with any of the Modu-Flo reservoirs on page 69.

## Rugged Versatility

The LubriSystem hand pump package offers versatility for use in any application, large or small. Great for operation with Injectors or Piston Distributors, with oil or grease. Sturdy construction of aluminum and steel to provide years of service. Compact design can be used in areas where space is limited. Rugged bracket allows the pump package to be mounted in place in any application.

### Modular Design

Combine the bare pump with any Modu-Flo reservoir from page 69 to build a custom package.

### Pressure Gauge

Provides visual assurance to the operator that pressure is building to “fire” the injectors.



Pump 563580 shown with 12 lb grease reservoir 562884 and pressure gauge 557864

### Polycarbonate Reservoir

High-strength, shatter-resistant material.

### Built-in Vent Valve

Pull handle from half-stroke to full-stroke repeatedly to build pressure, then return the handle to vertical position to vent the pressure.

### Technical Specifications

Pump Output	0.125 in <sup>3</sup> (2 cm <sup>3</sup> ) per full stroke
Output Pressure	3,000 psi (207 bar)
Force to Operate Handle	20 lb (9 kg) per 1,000 psi (69 bar)
Instruction Manual	L12100

### Typical Fluids

- Oil and Grease up to NLGI #1

### Typical Applications

- General machinery lubrication where power is limited or not available

## Ordering Information

### LubriSystem Pump

Part Number	Description
563580	Pump (without reservoir)

### Accessories

Part Number	Description
557864	3,000 PSI / 210 bar dual scale pressure gauge

### Reservoir Options





To create your own custom pump package, combine pump 563580 with any of the Modu-Flo reservoirs on page 69.



# CONTROLLERS

	Page
Controller Selection Guide .....	96-97
GLC™ X Controller and Auto Lube™ App .....	98-99
GLC™ 4400 Controller .....	100
GLC™ 2200 Controller .....	101-102
Grease Jockey® Timer .....	103-104
Solid State Timer .....	105
Controller Accessories .....	106-107

# Controller Selection Guide

Controller	Markets	Power Type	Inputs/Outputs	Modes	Reference Page
<b>GLC X™ Controller and Auto Lube™ App</b> 	<ul style="list-style-type: none"> <li>• Energy, Infrastructure and Heavy Equipment</li> <li>• In-Plant Manufacturing</li> <li>• Vehicle Service</li> </ul>	9–30 VDC	4/2	Pressure / Cycle / Timer	98-99
<b>GLC™ 4400 Series Controller</b> 	<ul style="list-style-type: none"> <li>• Energy, Infrastructure and Heavy Equipment</li> <li>• In-Plant Manufacturing</li> <li>• Vehicle Service</li> </ul>	9–30 VDC or 100–240 VAC	4/4	Pressure / Cycle / Timer	100
<b>GLC™ 2200 Series Controller</b> 	<ul style="list-style-type: none"> <li>• Energy, Infrastructure and Heavy Equipment</li> <li>• In-Plant Manufacturing</li> <li>• Vehicle Service</li> </ul>	9–30 VDC	2/2	Pressure / Cycle / Timer	101-102
<b>Grease Jockey® Timer</b> 	<ul style="list-style-type: none"> <li>• Energy, Infrastructure and Heavy Equipment</li> <li>• Vehicle Service</li> </ul>	9–30 VDC	0/1	Timer	103-104
<b>Solid State Timer</b> 	<ul style="list-style-type: none"> <li>• Energy, Infrastructure and Heavy Equipment</li> <li>• In-Plant Manufacturing</li> </ul>	115/230 VAC	0/1	Timer	105

# Controller Selection Guide

Feature	Standalone Controllers						Integrated Controllers			
	GLC-X	GLC 4400 AC (24B596)	GLC 4400 DC (24B591)	GLC 2200 (24N468)	Grease Jockey Timer (24W482)	Solid State Timer (562872)	G3 Max	G3 SP	G3 Pro	G-Mini Controller
Voltage	9-30 VDC	100-240 VAC	9-30 VDC	9-30 VDC	9-30 VDC	115/230 VAC	AC: 88-264 VAC 24V: 18-32 VDC 12V: 9-16 VDC			24V: 18-32 VDC 12V: 9-16 VDC
AC Frequency	–	50/60 Hz	–	–	–	50/60 Hz	AC: 47-63 (50/60) Hz – DC: N/A			–
Max amps (pump output)	10 A	10 A	5 A	7 A		3 A	Internal connection only			
Min On Time	10 secs	1 sec		1 sec		~ 12 secs	1 sec*	4 mins/cyc	1 sec*	1 min
Max On Time	100 hrs (99:59:59) (Timeout) Must be < Interval	100 hrs (99:59:59)		60 mins (59:59)		13 mins	30 mins	4 mins/cyc	30 mins	30 mins
Minimum Cycle Count	1	1 (optional)		1 (optional)	–	–	1 (optional)	1	–	1
Maximum Cycle Count	100	9,999		99	–	–	9,999	99	–	99
Pressure Switch Function	Configurable for both injectors and divider valves	Configurable for both injectors and divider valves		For injectors only	–	–	For injectors only	–	–	–
Min Off Time	1 min (Interval) Must be > Timeout	1 sec		1 min		30 secs	1 min	15 mins	1 min	15 min
Max Off Time	100 hrs (99:59) (Interval)	9,999 hrs		100 hrs (99:59)		32 hrs	9,999 hrs	9,999 hrs	9,999 hrs	99 hrs
Stroke/Machine Count	Yes	Yes		–	–	–	Yes	–	–	–
Minimum Stroke/Machine Count	1	1 (optional)		–	–	–	1 (optional)	–	–	–
Maximum Stroke/Machine Count	10,000	9,999		–	–	–	9,999	–	–	–
Pulse mode for pump	Auto Lube App**	Yes		Yes	–	–	–	–	–	–
PreLube	Yes	Yes		–	–	–	Yes	–	Yes	Yes
PreLube Delay	Yes	Yes		–	–	–	Yes	–	Yes	Yes
Low Level Input	Yes	Yes		Yes	–	–	Internal connection only			
Low Level Output	Auto Lube App**	Yes		Yes	–	–	Yes	Yes	Yes	Yes
Alarm Output	Auto Lube App**	Yes		Yes	–	–	Yes	Yes	LL only	Yes
OK Signal	Auto Lube App**	Yes		–	–	–	–	–	–	–
Manual Run (onboard)	Yes	Yes		Yes	Yes	Yes	Yes	Yes	Yes	Yes
Remote Manual Run	Auto Lube App**	Yes		–	–	–	Yes	Yes	Yes	Yes
Enclosure Rating (None are explosion proof)	IP69K	IP69K		IP54	IP54	N/A	IP69K	IP69K	IP69K	IP69K
Page Number	98	100		101-102	103-104	105	17	17	17	13-14

\*Note: The 22 rpm motor needs 3 seconds to stroke the G3 or EGJ piston pump once. \*\*These features are available via a Bluetooth connection to the Graco Auto Lube app on your smartphone or tablet.

## Drive More Productivity

The powerful, easy-to-use Graco GLC X automatic lubrication controller captures more information so operators, technicians and managers can make faster, smarter decisions. Paired with the intuitive Auto Lube app, users can monitor system performance and make adjustments with incredible speed, precision and freedom from their personal mobile device.



### Indoor/Outdoor Mountable (IP69K)

Designed to withstand all the elements, including high-pressure washes and inclement weather encountered at the harshest and dirtiest sites.

### Easy-to-Read Screen

High-contrast screen features text codes, faults and other data clearly in any ambient light without distracting operators.

### Real-Time System Reporting

Program and display a wide range of customizable functions – including lubrication intervals, pressure limits, lubricant levels and more.

### Smart Device and Mobile App

With the Auto Lube™ app, monitor lubrication levels, configure settings, track history and share important diagnostics.



### Universal Compatibility

One controller for all your lubrication systems simplifies training and inventory.

### Quick Technical Information Access

Easily scan this QR code for access to instruction manuals, guides, video tutorials and more.



**Scan Me!**

### Active Current Protection

9-30 VDC, 10 amp continuous power supply protects grease pumps from overcurrent and entire system from misfires, electrical shorts and surges.

#### Typical Applications

- Heavy construction
- Mining
- Other off-road mobile equipment

#### Technical Specifications

Inputs/Outputs	4/2
Power Source	9-30 VDC
Modes	Pressure / Cycle / Timer
Dimensions	3.62 in (92 mm) wide x 6.66 in (169 mm) high x 1.98 in (50 mm) deep
Operating Temperature Range	-22°F to 158°F (-30°C to 70°C)
Protection Grade	IP69K
Instruction Manual	3A7031

## Ordering Information

### Controllers

Part Number	Description
26A855	GLC X controller with 20 ft (6 m) cable
26A814	GLC X controller

### Accessories

	Part Number	Description
	26A853	GLC X pump and sensor simulator
	26A882	GLC X wiring harness, 20 ft (6 m) with flying leads
	26A883	GLC X to Compact Dyna-Star®, 3 ft (1 m) cable
	26A888	14-pin mating connector kit
	17G007	Yellow iron mounting bracket with slide adjustment



## Productivity Leads to Profitability

Help your crews work faster and minimize downtime by simplifying their everyday lubrication tasks. Designed for today's modern personal mobile device user, the **Graco Auto Lube App** is intuitive and easy to learn for users in the field. They can view historical performance charts, access support and share information with a tap or swipe.

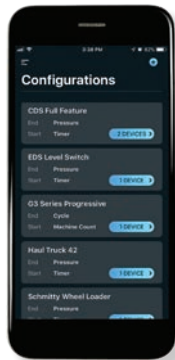

### Control Lubrication Profile Configurations

- Customize profiles for equipment and end users
- Quickly and easily assign a Lube Profile Configuration with a GLCX Controller

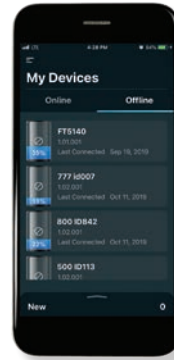

### Manage Devices

- Connect via Bluetooth to get instant status
- Review last-known state on any historical device

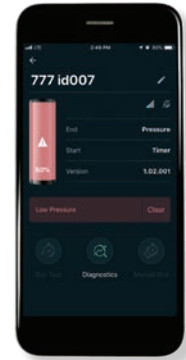

### Communicate in Real Time

- See, control, check and clear alarms
- Complete a manual run
- Review and share system history

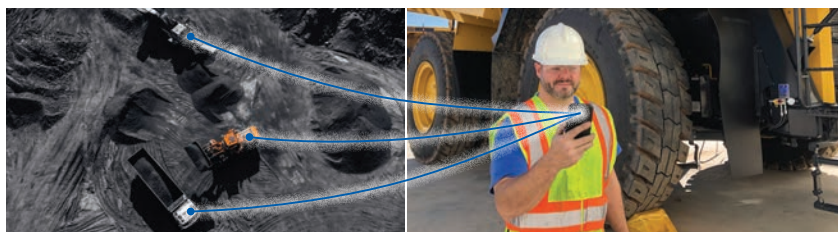

Workers simply need to be within Bluetooth range to perform maintenance tasks faster and easier – directly from their mobile devices.

Download the **Graco Auto Lube** app from Google Play or the App Store (iOS) and perform all controller functions from the convenience of a smartphone or tablet.

## Easily Manage Your Auto Lube System

Loaded with features and simple to operate. A must-have controller for ensuring critical machine lubrication.

### Lubrication Indicator

Confirms lubrication cycle status

### Pressure/Cycle Input

Indicates input from system sensors

### System Power LED

On/off status at a glance

### Alarm

System fault alerts

### Multi-functional Buttons

For easy programming and system operation

### Backlit and Heated LCD Display

Adjustable brightness and contrast for sunny or dark conditions, plus the heated display allows for use in cold weather

### Simple Navigation

Arrow buttons for easy navigation of intuitive menus



### Typical Applications

- Heavy construction
- Mining
- Off-road mobile
- In-plant machinery
- Food and beverage equipment
- Wind energy

### Technical Specifications



Dimensions	4.7 in H x 4.8 in W x 3.6 in D (120 mm H x 122 mm W x 91 mm D)
Protection Grade	IP69K
Operating Temperature Range	-40°F to 145°F (-40°C to 63°C)
Net Weight	2 lbs (0.9 kg)
Standards	CE Marked
Instruction Manual	313855

### Ordering Information

#### Controllers

Part Number	Description
24B591	GLC 4400 controller – 9-30 VDC
24B596	GLC 4400 controller – 100-240 VAC

#### Accessories

	Part Number	Description
	17J939	Machine/stroke count inductive sensor – 12-24 VDC. NPN normally open, M12 male, 5 mm sensing distance.
	557781	Machine/stroke count SPTD dry contact limit switch – AC/DC. Can be wired N.O. or N.C. Use with cable 124300 and cord grip 260067.

### Remember to Order!

 <b>Proximity Switches</b> See page 161-162	 <b>Pressure Switches</b> See page 204
--	--

## Compact and Versatile for Demanding On-Vehicle Auto Lube

You spend a lot on your equipment. The GLC 2200 controller helps protect components by alerting you to lube events, lube failures and low lubrication levels. You have peace of mind knowing your investment is being protected.



### External Mounting Tabs

Easy to mount without having to open up the control box.

### LED Indicators

LED lights let you know what your system is doing at a glance.

### Digital Readout

Easy-to-read digital display makes it simple to program and monitor your equipment.

### Visual and Audible Alarms

In-cab visual and audible alarms let the operator know your equipment needs attention. Or set up a remote alarm to alert service or maintenance staff.

### Intuitive, Protected Control

Simple icon-based push buttons make programming easy. PIN code lockout protects settings.

### Plug and Play

Color-coded wiring harness with flying leads and easy-to-follow wiring diagrams makes installations efficient.

### Typical Applications

- Heavy construction
- Mining
- On-road mobile
- Off-road mobile

### Technical Specifications





Dimensions	5.53 in H x 2.75 in W x 1.38 in D (140 mm H x 70 mm W x 35 mm D)
Protection Grade	IP54
Operating Temperature Range	-40°F to 176°F (-40°C to 80°C)
Standards	CE Marked
Power Source DC	9 to 30 VDC
Instruction Manual	3A2960

## Ordering Information

### Controller

Part Number	Description
24N468	GLC 2200 controller

### Accessories

	Part Number	Description
	24P314	GLC 2200 wiring harness – 5 feet (1.5 m) with flying leads
	24W981	GLC 2200 wiring harness – 10 feet (3 m) with flying leads
	24P686	10-pin mating connector kit
	24P687	10-pin mating connector kit – 5 pack
	16T671	Crimper for 10-pin connector kits
<i>Image Coming Soon</i>	24X606	Mounting bracket kit
	17G007	Yellow iron mounting bracket with slide adjustment

### Remember to Order!

 <p><b>Proximity Switches</b> See page 161-162</p>	 <p><b>Pressure Switches</b> See page 204</p>
---	--

## Drive More Productivity

Graco's Grease Jockey® Timer is a compact and digital solution for on-road mobile lubrication with simple programming and easy connections. Mount in the cab to complete your pneumatic Grease Jockey auto lube system.

### External Mounting Tabs

Easy to mount without having to open up the control box.

### LED Indicators

LED lights let you know what your system is doing at a glance.

### Digital Readout

Easy-to-read digital display makes it simple to program and monitor your equipment.

### Visual and Audible Alarms

In-cab visual and audible alarms let the operator know your equipment needs attention. Or set up a remote alarm to alert service or maintenance staff.

### Intuitive, Protected Control

Simple icon-based push buttons make programming easy. PIN code lockout protects settings.

### Plug and Play

Color-coded wiring harness with flying leads and easy-to-follow wiring diagrams makes installations efficient.



### Typical Applications

- On-road mobile equipment

### Technical Specifications



Power Source	9-30 VDC
Dimensions	5.53 in H x 2.75 in W x 1.38 in D (140 mm H x 70 mm W x 35 mm D)
Operating Temperature Range	-40°F to 176°F (-40°C to 80°C)
Protection Grade	IP54
Instruction Manual	334662

## Ordering Information

### Grease Jockey Timers

Part Number	Description
25A118	Grease Jockey Timer with 10 ft (3 m) cable
24W482	Grease Jockey Timer

### Accessories

	Part Number	Description
	25C771	Grease Jockey Timer wiring harness – 10 ft (3 m) with flying leads
	24P686	10-pin mating connector kit
	24P687	10-pin mating connector kit – 5 pack
	16T671	Crimper for 10-pin connector kits
<i>Image Coming Soon</i>	24X606	Mounting bracket kit

## Flexible and Dependable

The Solid-State Timer from Graco is a compact on/off timer solution for AC power with easy to adjust dials. Features an internal terminal strip for simple wiring.

### System Power LED

On/off status at a glance

### Manual Run Button

Use to check system integrity as well as to simplify system filling and air purging

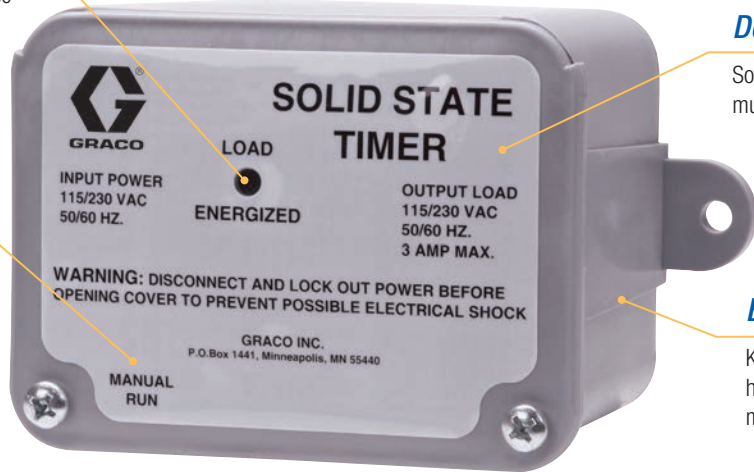

### Dependable Performance

Solid-state technology combined with multiple-level protection

### Built-In Memory

Keeps the timer "alive" for 1-1/2 hours during power failures and machine shutdown

### Typical Applications

- In-plant machinery

### Technical Specifications

Electrical	115/230 VAC; 50/60 hz; 3 ampere (max.)
Operating Temperature Range	0° to 131°F (-18°C to 55°C)
Storage Temperature Range	-67° to 185°F (-55°C to 85°C)
Enclosure	High-impact plastic
Component Technology	CE Marked
Cycle (Off Time) Range	
Range 1	0.5 to 30 minutes
Range 2	0.5 to 32 hours
On Time Range	0.2 to 13 minutes
Vibration	5g's 50 Hz
Instruction Manual	312055



### Ordering Information

Part Number	Description
562872	Solid State Timer
558031	Replacement timer board, without enclosure

## Controller Accessories

### Ordering Information

#### DT Connector Kits

	Part Number	Description
	26A889	12-pin DT female connector kit
	132571	12-pin DT male connector kit – with boot
	26A884	20 ft (6 m) cable, 12-pin DT male x flying leads, 2 x 16 AWG, 10 x 18 AWG. Use with connector kits 26A889 and 132571.

#### In-Line Fuse Kits

For up to 32 VDC

	Part Number	Description
<i>Image Coming Soon</i>	571039	Splash-proof holder with 4 amp blade fuse (557377 plus 124342)
<i>Image Coming Soon</i>	571040	Splash-proof holder with 7.5 amp blade fuse (557377 plus 124343)
<i>Image Coming Soon</i>	25C986	Weatherproof holder with 7.5 amp blade fuse (17P339 plus 124343)
<i>Image Coming Soon</i>	25C985	Weatherproof holder with 10 amp blade fuse (17P339 plus 131206)

#### Fuse Holders

For up to 32 VDC

	Part Number	Description
<i>Image Coming Soon</i>	131944	Add-a-circuit tap/holder, 32 VDC max, for ATM blade fuses up to 10 amps, 18 AWG wire lead.
<i>Image Coming Soon</i>	17D688	Add-a-circuit tap/holder, 32 VDC max, for ATO blade fuses up to 10 amps, 18 AWG wire lead.
<i>Image Coming Soon</i>	17P339	In-line holder with weatherproof cover, 32 VDC max, for ATO blade fuses up to 30 amps, 12 AWG wire leads.
<i>Image Coming Soon</i>	557377	In-line holder with splash-proof cover, 32 VDC max, for ATO blade fuses up to 20 amps, 16 AWG wire leads.

## Ordering Information

### Blade Fuses

For up to 32 VDC

	Part Number	Size	Amp Rating
<i>Image Coming Soon</i>	124342	ATO	4
	557264		5
	124343		7.5
	131206		10
	17P340		30
	131945	ATM	5

### Nylon Cable Ties

	Part Number	Description
	17K063	Single-loop, 14.75 in (375 mm), 100 count package
	563770	Single-loop, 11.5 in (292 mm), 100 count package
	26C980	Double-loop (Figure-8), 15 in (381 mm), 10 count package

### P-Clamps

	Part Number	Clamp diameter	Mounting hole diameter
	557943	5/16 in (7.9 mm)	9/32 in (7 mm)
	557946	3/8 in (9.5 mm)	
	557944	7/16 in (11.1 mm)	
	557945	5/8 in (15.9 mm)	
	128051	1 in (25.4 mm)	13/32 in (10 mm)

### Ring Terminals

	Part Number	Crimp Connector Insulation (Nylon)	Compatible Wire Gauge (AWG)	Compatible Screw/ Stud Size
<i>Image Coming Soon</i>	104911	Yellow	10-12	#10
	102258	Blue	14-16	3/8 in
	106595	Red	16-22	3/8 in
	109025	Not insulated	18-22	#10
	131230		18	1/4 in
	131229		10	3/8 in



# METERING

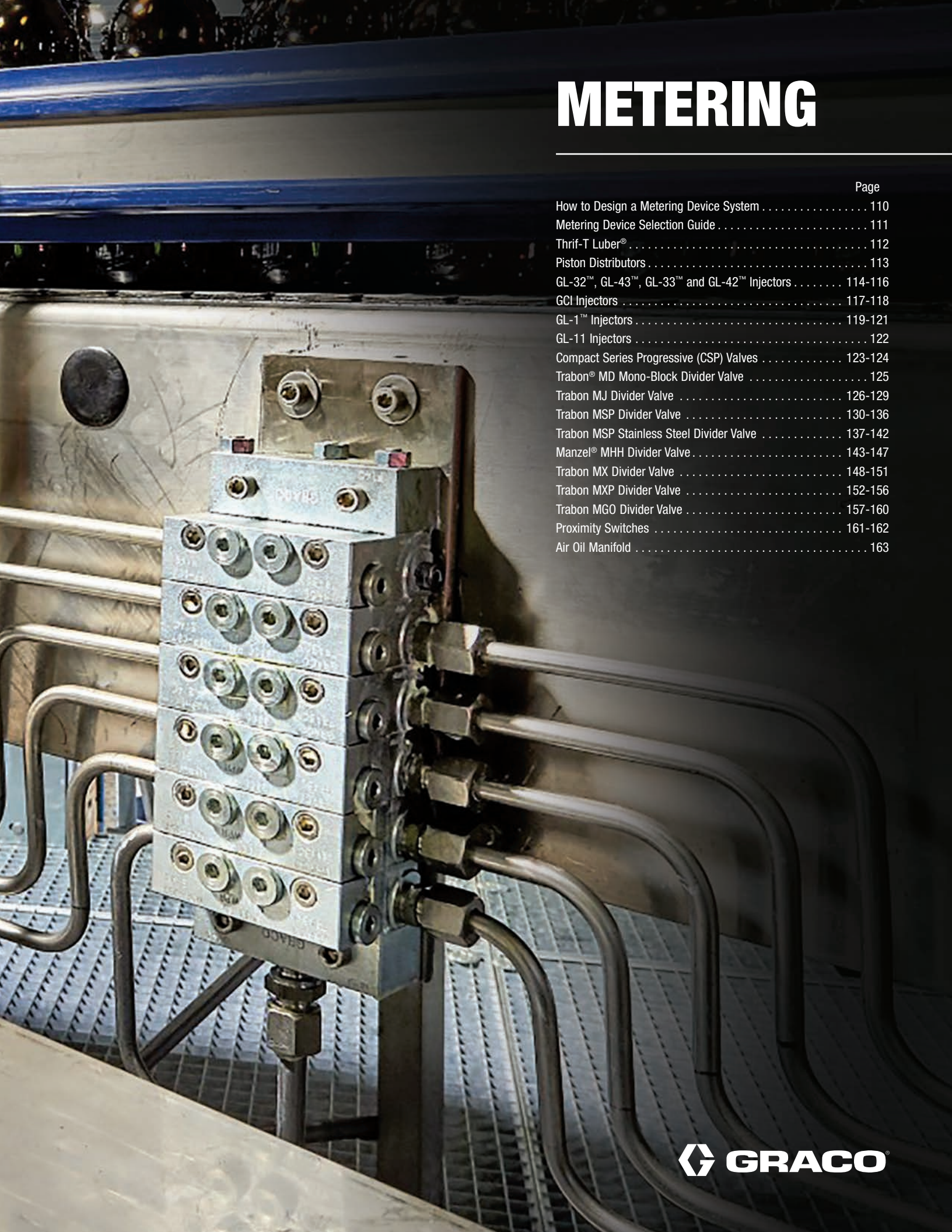

	Page
How to Design a Metering Device System .....	110
Metering Device Selection Guide .....	111
Thrif-T Luber® .....	112
Piston Distributors .....	113
GL-32™, GL-43™, GL-33™ and GL-42™ Injectors .....	114-116
GCI Injectors .....	117-118
GL-1™ Injectors .....	119-121
GL-11 Injectors .....	122
Compact Series Progressive (CSP) Valves .....	123-124
Trabon® MD Mono-Block Divider Valve .....	125
Trabon MJ Divider Valve .....	126-129
Trabon MSP Divider Valve .....	130-136
Trabon MSP Stainless Steel Divider Valve .....	137-142
Manzel® MHH Divider Valve .....	143-147
Trabon MX Divider Valve .....	148-151
Trabon MXP Divider Valve .....	152-156
Trabon MGO Divider Valve .....	157-160
Proximity Switches .....	161-162
Air Oil Manifold .....	163

## How to Design a Metering Device System

### At the heart of every automatic lubrication system is a Metering Device.

People often ask why they can't just put a tee in the line to serve two points. The fluid in such a system would take the path of least resistance, leading it to only one of the points. Metering devices are used to prevent fluid from taking the path of least resistance.

As the "heart" of automatic lubrication, the system design process starts with metering. Once the metering system is designed, then an appropriate pump, and usually a controller can be selected to meet the needs of the system that has been designed. Many accessories are also specific to a certain metering device, so accessory selection also depends on the metering device(s) selected for the system.

*Ultimately, the choice of which metering device to use for each application is often based on customer preference, but there are differences in functionality and sensor feedback which can influence the decision.*

To learn more about system design, including calculating bearing requirements, determining lubrication ratios and component selection, contact your local Account Manager for Graco Lubrication Equipment.

If you are a Graco distributor, you can also ask about upcoming training classes. Attending one of our free classes in person also gives you the opportunity to tour our impressive factory in Anoka, Minnesota!

# 1

### Select the Metering Device

Determined by your fluid type and usage requirements.

#### Metering Device Types

- SLR – Single Line Resistive Orifice – Not a true "metering" device; uses a helical path to create resistance on the oil flow.
- SLP – Single Line Parallel – Requires a pump with a Vent Valve to allow reset between cycles
- SPDV – Series Progressive Divider Valve – "Trabon" system that uses shifting pistons to measure and route the lubricant pumped through it. Offers the most monitoring options of any metering system.

METERING



# 2

### Select the Pump

Determined by your metering choice, fluid type and power source.

#### Pump Power Types

- |                                    |                                     |
|------------------------------------|-------------------------------------|
| <input type="checkbox"/> AC        | <input type="checkbox"/> Hydraulic  |
| <input type="checkbox"/> DC        | <input type="checkbox"/> Manual     |
| <input type="checkbox"/> Pneumatic | <input type="checkbox"/> Mechanical |

PUMP



# 3

### Select the Controller (if needed)

Determined by your usage needs and whether your selected pump offers an integrated controller.

CONTROLLER



# 4

### Add Accessories

Complete your metering system with high-quality Graco accessories including proximity and pressure switches, hoses, valves and fittings.

ACCESSORIES



# Metering Devices Selection Guide

Name	Type	Typical Applications	Fluid Type	Maximum Pressure psi (bar)	Max. Temperature degrees F (C)	Reference Page		
Thrif-T Luber	SLR	Ideal for small to medium-sized lathes or grinders	Oil – 100 SUS to 10,000 SUS	150 (10)	180 (82)	112		
Injecto-Flo II	SLP	Medium-sized cutting machine tools	Oil – 32 to 2,000 cSt	650 (45)	140 (60)	113		
GL-32		In-plant machinery, mobile equipment and anywhere adjustable lubrication output is desired	Grease up to NLGI #2	3,500 (241)	350 (176)	114		
GL-43			Oil –10 weight minimum	1,000 (69)		114		
GL-33			Grease up to NLGI #2	3,500 (241)		115		
GL-42			Oil –10 weight minimum	1,000 (69)		115		
GL-1			Grease up to NLGI #2	3,500 (241)	117-119			
GL-1 Oil			Oil –10 weight minimum		117-119			
GL-1 SST			Grease up to NLGI #2		117-119			
GCI			Grease up to NLGI #2	5,000 (345)	250 (121)	117-118		
GL-1 X			Grease up to NLGI #2	6,000 (414)	350 (176)	119-121		
GL-1 XL			Grease up to NLGI #2			119-121		
GL-11			Grease up to NLGI #2	3,500 (241)		122		
CSP			SPDV	Industrial or mobile applications where space is at a premium	Oil and grease up to NLGI #2	5,076 (350)	212 (100)	123-124
MD					Oil and grease up to NLGI #2	3,000 (207)	212 (100)	125
MJ	Industrial applications where space is at a premium, and diverse output ratios are needed			Oil and grease up to NLGI #1	2,000 (138)	200 (93)	126-129	
MSP	Mobile, industrial, food and beverage, wind and many more	Oil and grease up to NLGI #2		3,500 (241)	350 (176)	130-136		
MSP SST	Food and beverage, off-shore rigs, marine lift cranes, locks and dams, pulp and paper production, chemical processing, oil and gas applications, and other harsh environments such as salty air or areas needing repetitive cleaning	Oil and grease up to NLGI #2		3,500 (241)	140 (60)	137-142		
MHH	Compressors, industrial equipment, and where high-pressure lubrication is required	Synthetic or Mineral Oil		7,500 (517)	350 (176)	143-147		
MX	Pulp and paper, steel mills, heavy- and high-volume industrial applications	Oil and grease up to NLGI #2		3,000 (207)	200 (93)	148-151		
MXP		Oil and grease up to NLGI #2		3,000 (207)	350 (176)	152-156		
MGO		Oil and grease up to NLGI #2		6,000 (414)	350 (176)	157-160		
Air/Oil Manifold	SPDV	Steel mills, pulp and paper processing, high temperature and dirty environments			250 (17)	200 (93)	163	

## Metering Types Explained

SLR	Single Line Resistive Orifice – Not a true "metering" device; uses a helical path to create resistance on the oil flow.
SLP	Single Line Parallel – Requires a pump with a Vent Valve to allow reset between cycles
SPDV	Series Progressive Divider Valve – "Trabon" system that uses shifting pistons to measure and route the lubricant pumped through it. Offers the most monitoring options of any metering system.

## Simple Solutions for Tight Spaces and Budgets

Thrif-T Luber orifice systems offer an efficient method of applying lubricant, resulting in less machine downtime, increased productivity and a safer work environment. Available in three types and ten flow ranges to meet lube requirements.

### Compression Nut With Captured Ferrule Included

For fast, easy connection to 5/32 in (4 mm) OD tubing.



564020

### Quality Sintered Bronze Filters

Won't shred or clog like felt.



564034

#### Typical Applications

- Simple time and flow metering system; ideal for small to medium-sized lathes or grinders

#### Typical Fluids

- Oil – 100 SUS to 10,000 SUS

#### Technical Specifications

Cracking Pressure	2 psi (0.1 bar)
Maximum Pressure	150 psi (10 bar)
Filter Rating	40 micron
Orifice Type A	Direct to bearing
Orifice Type B	Manifold
Orifice Type A	Direct to bearing or tee

## Ordering Information

### 1/8 in NPT Male Bearing Fitting

Compression fitting for 5/32 in (4 mm) OD tubing. All three parts are required to make one complete fitting. May also be used inline to mate with standard 1/8 in NPT "female" fittings such as anchor blocks, tees, etc.

<i>Image Coming Soon</i>	558220	TLBF-00	Fitting Body with 1/8 in NPT male thread
	558189	TLCN-00	Compression Nut
	558188	TLCF-00	Compression Ferrule

### Tube Clips

Zinc plated carbon steel clips for 5/32 in (4 mm) OD tubing.

<i>Image Coming Soon</i>	558156	TLTC-01	1-Tube
	558159	TLTC-04	4-Tubes

### Other Accessories

<i>Image Coming Soon</i>	558190	TLIF-00	5/16 in-24 Inverted Compression Nut, used to attach tubing to manifold. Also requires ferrule 558188
--------------------------	--------	---------	--

### Thrif-T Luber Resistive Orifices

	Part Number	Reference/Description
	Type A	
	564019	TLOA-0
	564020	TLOA-1
	564021	TLOA-2
	564022	TLOA-3
	564024	TLOA-5
	564025	TLOA-2/0
	Type C	1/8 in NPTF mbe
	564034	TLOC-5

## Compact Metering System with a Wide Range of Outputs

Ideal for medium-sized cutting machine tools.

### Piston Distributor Style Single Line Meters

Known worldwide for fast, simple installation.



### Metering Nipples

Can be changed to fine-tune your dispense volumes.

#### Typical Applications

- Compact metering system with a wide range of outputs; ideal for medium-sized cutting machine tools

#### Typical Fluids

- Oil – 32 to 2,000 cSt

#### Technical Specifications

	3400 Series	3500 Series	3900 Series
Oil/Fluid Grease	Oil	Oil	Oil
Reset Pressure	150 psi (10 bar)	150 psi (10 bar)	150 psi (10 bar)
Max. Operating Pressure	650 psi (45 bar)	650 psi (45 bar)	650 psi (45 bar)
Output Range	0.0006 to 0.009 in <sup>3</sup> (0.01 to 0.16 cm <sup>3</sup> )	0.006 to 0.036 in <sup>3</sup> (0.1 to 0.6 cm <sup>3</sup> )	0.012 to 0.09 in <sup>3</sup> (0.2 to 1.5 cm <sup>3</sup> )
Metering Nipple Options	5	4	5
Cast Manifold Outlets	2, 3 or 5	2, 3 or 5	2 or 3

#### Ordering Information

##### 3400 Series Single Point Piston Distributors – Oil

558306	0.01 cm <sup>3</sup> output, M8 x 1
558307	0.03 cm <sup>3</sup> output, M8 x 1
558308	0.06 cm <sup>3</sup> output, M8 x 1
558309	0.10 cm <sup>3</sup> output, M8 x 1
558310	0.16 cm <sup>3</sup> output, M8 x 1

##### 3500 Series Single Point Piston Distributors – Oil

121658	0.10 cm <sup>3</sup> output, M10 x 1
121659	0.20 cm <sup>3</sup> output, M10 x 1
121660	0.40 cm <sup>3</sup> output, M10 x 1
121661	0.60 cm <sup>3</sup> output, M10 x 1

##### 3900 Series Single Point Piston Distributors – Oil

121665	0.20 cm <sup>3</sup> output, M14 x 1.5
121668	1.00 cm <sup>3</sup> output, M14 x 1.5

##### 3400 Cast Manifolds

122841	2 outlets, oil PD, complete with red plastic cover
122861	3 outlets, oil PD, complete with red plastic cover
122862	5 outlets, oil PD, complete with red plastic cover

##### 3400 Metering Nipples

558311	0.03 cm <sup>3</sup> (#2)
558312	0.06 cm <sup>3</sup> (#3)
558313	0.10 cm <sup>3</sup> (#4)
558314	0.16 cm <sup>3</sup> (#5)

##### 3500 Cast Manifolds

122866	2 outlets, oil PD, complete with red plastic cover
122868	3 outlets, oil PD, complete with red plastic cover
122869	5 outlets, oil PD, complete with red plastic cover

##### 3500 Metering Nipples

558315	0.10 cm <sup>3</sup> (#4)
558316	0.20 cm <sup>3</sup> (#5)
558317	0.40 cm <sup>3</sup> (#6)
558318	0.60 cm <sup>3</sup> (#7)

##### 3900 Cast Manifolds

122888	2 outlets, oil PD, complete with red plastic cover
122889	3 outlets, oil PD, complete with red plastic cover

##### 3900 Metering Nipples

558321	0.60 cm <sup>3</sup> (#7)
558322	1.00 cm <sup>3</sup> (#8)
558323	1.50 cm <sup>3</sup> (#9)

# GL-32™ and GL-43™ Injectors

## Accurate, Reliable Lubrication for Every Lube Point on Your Machine

With its one piece design, Graco's GL grease injector systems are easy to design, fast to set up and allow you to add or subtract lube points without having to redesign your lubrication system. Easily handles up to NLGI #2 grease.

### Adjustable Lubrication For Each Lube Point

Systems are easy to design, fast to set up and allow you to add or subtract lube points without having to redesign your lubrication system.

### Versatile High Performance

Versions for oil or grease grades to NLGI #2.

### High Temperature Applications – Up To 350°F (176°C)

All injectors come standard with fluoroelastomer seals.



### Large Selection of Outlet Types and Manifold Quantities

Convenient options for any application.

#### Typical Applications

- In-plant machinery, mobile equipment and anywhere adjustable lubrication output is desired

#### Typical Fluids

- Oil (10 weight minimum) and grease up to NLGI #2

#### Technical Specifications

	GL-32 Grease Injectors	GL-43 Oil Injectors
Maximum Operating Pressure	3,500 psi (241 bar)	1,000 psi (69 bar)
Minimum Operating Pressure	1,200 psi (83 bar)	750 psi (52 bar)
Typical Operating Pressure	1,500 psi (103 bar)	850 psi (59 bar)
Reset Pressure	200 psi (13.7 bar)	150 psi (10 bar)
Output Volume Per Cycle (adjustable)	0.001 to 0.008 in <sup>3</sup> (0.02 to 0.13 cm <sup>3</sup> )	
Maximum Temperature Rating	350°F (176°C)	
Cycle Indication	Visual pin	
Instruction Manual	313798	

#### Ordering Information

Number of Injectors	Inlet Thread	Outlet Fitting	GL-32 Grease		GL-43 Oil	
			Carbon Steel	304 Stainless	Carbon Steel	
Stand-Alone	1/4 in NPT male	1/8 in OD tube compression	24A919*	24E389*	24E240*	
1	1/4 in NPT female		24A921	24E391	24E241	
2			24A922	24E392	24E242	
3			24A923	24E393	24E243	
4			24A924	24E394	24E244	
6			25T775	–	–	
Replacement			N/A	24A920*	24E390*	24E245*
Stand-Alone	1/4 in NPT male	6 mm OD tube compression	24F507	–	24F542	
1	1/8 in BSPP female		24F509	24F551	24F544	
2			24F510	24F552	24F545	
3			24F511	24F553	24F546	
4			24F512	24F554	24F548	
Replacement			N/A	24F508*	24F550*	24F543*
Repair/Overhaul Kit			N/A	N/A	24B360	24F944

\*Must be ordered in quantities of five.

See page 116 for alternate and replacement outlet fittings and more accessories.

## Life-Long Seals

Graco-quality manifold and indicator seals deliver increased productivity.

## Seven Output Fitting Sizes

Use your preferred size of tubing or hose.

## Wide Range of Manifold Options

Manifolds designed to hold up to 15 injectors decreases installation time.

## Adjustable Injector Output

Adjust output volume on each injector for a custom fit in any application.

## One-Piece Machined Body

Provides durability not seen in other brands.

## Visual Indicator Pin

Convenient front-mounted cycle pin indicator confirms that the injector is functioning properly.

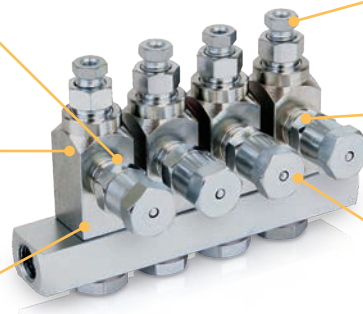

### Typical Applications

- In-plant machinery, mobile equipment and anywhere adjustable lubrication output is desired

### Typical Fluids

- Oil (10 weight minimum) and grease up to NLGI #2

### Technical Specifications

	GL-33 Grease Injectors	GL-42 Oil Injectors
Maximum Operating Pressure	3,500 psi (241 bar)	1,000 psi (69 bar)
Minimum Operating Pressure	1,200 psi (83 bar)	750 psi (52 bar)
Typical Operating Pressure	1,500 psi (103 bar)	850 psi (59 bar)
Reset Pressure	200 psi (13.7 bar)	150 psi (10 bar)
Output Volume Per Cycle (adjustable)	0.001 to 0.003 in <sup>3</sup> (0.02 to 0.05 cm <sup>3</sup> )	
Maximum Temperature Rating	350°F (176°C)	
Cycle Indication	Visual Pin	
Instruction Manual	334495	

### Ordering Information

Number of Injectors	Inlet Thread	Outlet Fitting	GL-33 Grease		GL-42 Oil		
			Carbon Steel	304 Stainless	Carbon Steel		
Stand-Alone	1/8 in NPT male	1/8 in OD tube compression	24W487*	24W489*	24W493*		
1	1/8 in NPT female		24W401	24W601	24W801		
2			24W402	24W602	24W802		
3			24W403	24W603	24W803		
4			24W404	24W604	24W804		
5			24X302	24X304	24X306		
6			24W405	24W605	24W805		
7			25R873	–	–		
9			24W406	–	24W806		
10			24W407	24W606	24W807		
15			24W408	24W607	24W808		
Replacement			N/A	24W483*	24W485*	24W491*	
Stand-Alone			1/8 in NPT male	6 mm OD tube compression	24W488*	24W490*	24W494*
1			1/8 in BSPP female		24W501	24W701	24W901
2					24W502	24W702	24W902
3		24W503			24W703	24W903	
4	24W504	24W704			24W904		
5	24X303	24X305			24X307		
6	24W505	24W705			24W905		
10	24W506	24W706			24W906		
15	24W507	24W707			24W907		
Replacement	N/A	24W484*			24W486*	24W492*	
Repair/Overhaul Kit	N/A	24W913			24W914	24W915	

\*Must be ordered in quantities of five.

See page 116 for alternate and replacement outlet fittings and more accessories.

# Accessories for GL-32™, GL-33™, GL-42™ and GL-43™ Injectors

## Ordering Information

		GL-32, GL-33, GL-42 and GL-43 Outlet Fittings		
		Carbon Steel	Stainless Steel	Nickle-Plated Brass
Porting	JIC-4 male	17B168	17B169	–
	1/8 in OD tube	24B677	24F943	–
	1/8 in OD Push-to-Connect	–	–	17B879
	1/4 in OD Push-to-Connect	–	–	17B880
	1/8 in NPT female	17B780	17B781	–
	4 mm OD tube	24F513	24F555	–
	6 mm OD tube	24F514	24F556	–
	Closure Plug	17B782	17B783	–

## Accessories

24W495	Manual grease fitting adapter – compatible with 1/8 in OD tube outlet only
17B785	Measuring chamber vinyl cap

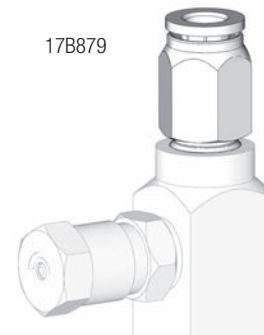

17B879

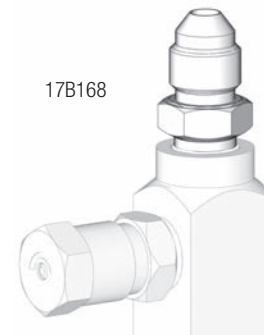

17B168

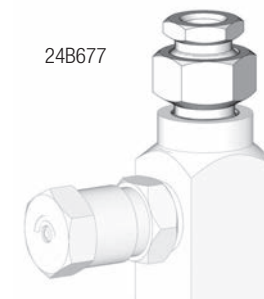

24B677



17B780



17B782



17B785

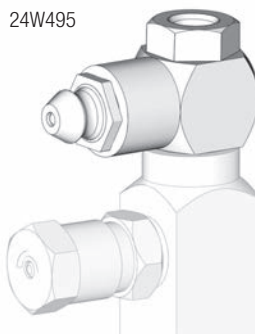

24W495

## Injector Technology That Defies Convention

This revolutionary, new patent pending cartridge injector system from Graco ushers in a new era of automatic lubrication system technology! This system will reduce maintenance frequency, labor and costly downtime and will transform uptime, production capacity and profitability expectations.

### Quick-Exchange Injectors

Injector replacements take seconds rather than minutes using either a 24 mm or 15/16 in. socket – without the need to remove any lubrication lines.

### Backward Compatible

Uses same mounting pattern as GL-1 and GL-1 X series injectors that also match many competitive mounting patterns.



### Locked-In Output

Color-coded output spacers dictate the amount of grease dispensed per lubrication cycle, reducing the likelihood of incorrect field adjustments during repair.



### Greater Output Range

0.015 to 0.150 in<sup>3</sup>, nearly doubling the output of our GL-1 injectors, reducing the need for crossporting multiple injectors in a system

**PATENT PENDING**

Single Line Parallel

## Technical Specifications

Maximum Pressure	Standard-pressure manifold (aluminum) – 3,500 psi (24.1 MPa, 241 bar) High-pressure manifold (steel) – 5,000 psi (34.5 MPa, 345 bar) GCI 150 cartridges – 5,000 psi (34.5 MPa, 345 bar)
Recommended Operating Pressure	2,500 psi (17 MPa, 172 bar)
Reset Pressure	1,000 psi (6.89 MPa, 68.9 bar)
Output Volume Per Cycle	0.015 to 0.150 in <sup>3</sup> (.25 to 2.46 cm <sup>3</sup> )
Recommended Fluids	NLGI #2 grease down to 32° F (0° C)
Wetted Materials	Carbon steel, nitrile rubber, aluminum

## Manifold Dimensions

	2-Point	3-Point	4-Point	5-Point	6-Point
Width in. (cm)	3.13 (7.94)	4.38 (11.11)	5.63 (14.29)	6.88 (17.46)	8.13 (20.64)
Height in. (cm)	3.4 (8.64)				
Distance Between Mounting Holes in. (cm)	–	1.25 (3.18)	2.50 (6.34)	3.75 (9.51)	5.00 (12.70)

## Ordering Information

Graco cartridge injectors are easy to handle, can be serviced in one minute or less and eliminate the need to disconnect lines when replacing. Numerous injector replacements on a machine can be completed in minutes instead of hours, leaving service technicians with more time to focus on other equipment issues.

### Standard-Pressure Manifolds

Zerks and caps included

Part Number	Description
134362	2-point manifold, 3,500 psi
134363	3-point manifold, 3,500 psi
134364	4-point manifold, 3,500 psi
134365	5-point manifold, 3,500 psi
134366	6-point manifold, 3,500 psi

### High-Pressure Manifolds

Zerks and caps included

Part Number	Description
134372	2-point manifold, 5,000 psi
134373	3-point manifold, 5,000 psi
134374	4-point manifold, 5,000 psi
134375	5-point manifold, 5,000 psi
134376	6-point manifold, 5,000 psi

### GCI 150 Injectors

Part Number	Description
134250	Injector – single
134354	Injector – 100-pack

### Output Spacers

Part Number	Color	Output Target in <sup>3</sup> (cm <sup>3</sup> )
134337	Black	0.015 (0.25)
134338	Red	0.030 (0.49)
134339	Silver	0.045 (0.74)
134340	Gold	0.060 (0.98)
134341	Green	0.080 (1.31)
134342	Gray	0.100 (1.64)
134343	Purple	0.125 (2.05)
134344	Blue	0.150 (2.46)

### Accessories

Part Number	Description
134105	Injector crossport kit
133668	Injector port plug
114916	Zerk and cap fitting
134393	Dust cap replacement



## Graco Quality Provides Consistent Performance in Rugged Environments

Custom fit your system with Graco's adjustable GL-1 series grease injectors. Designed to meet the needs of each lube point, these systems provide years of reliable operation in the harshest operating environments.

### Injector Covers

Clear, polycarbonate covers protect cycle pin indicators from contamination. (Included with GL-1 X and GL-1 XL models)

### Hex-Head Adjustment Nut

Heavy-duty hex-head nut makes output adjustments simple.

### Unibody Design

Rugged, single-piece body for use in harsh environments.

### GL-1 Manifold

6,000 psi, 3/8 in NPT port manifolds fit pre-existing mounting patterns.

### Output Spectrum Sleeves

Colored-coded spacers enable simple, targeted output volume.



Single Line Parallel

## Technical Specifications

	GL-1	GL-1 Oil	GL-1 SST	GL-1 X	GL-1 XL
Maximum Operating Pressure	3,500 psi (241 bar)	3,500 psi (241 bar)	3,500 psi (241 bar)	6,000 psi (414 bar)	6,000 psi (414 bar)
Minimum Operating Pressure	1,850 psi (128 bar)	750 psi (52 bar)	1,850 psi (128 bar)	1,850 psi (128 bar)	1,850 psi (128 bar)
Reset Pressure	600 psi (41 bar)	150 psi (10 bar)	600 psi (41 bar)	1,000 psi (69 bar)	1,000 psi (69 bar)
Output Volume Per Cycle	0.008 to 0.08 in <sup>3</sup> (0.13 to 1.31 cm <sup>3</sup> )	0.008 to 0.08 in <sup>3</sup> (0.13 to 1.31 cm <sup>3</sup> )	0.008 to 0.08 in <sup>3</sup> (0.13 to 1.31 cm <sup>3</sup> )	0.015 to 0.08 in <sup>3</sup> (0.25 to 1.31 cm <sup>3</sup> )	0.035 to 0.305 in <sup>3</sup> (0.57 to 5.0 cm <sup>3</sup> )
Materials	Zinc-plated carbon steel	Zinc-plated carbon steel	316 stainless steel	Zinc-plated carbon steel	Zinc-plated carbon steel

# GL-1™ Injectors

Single Line Parallel

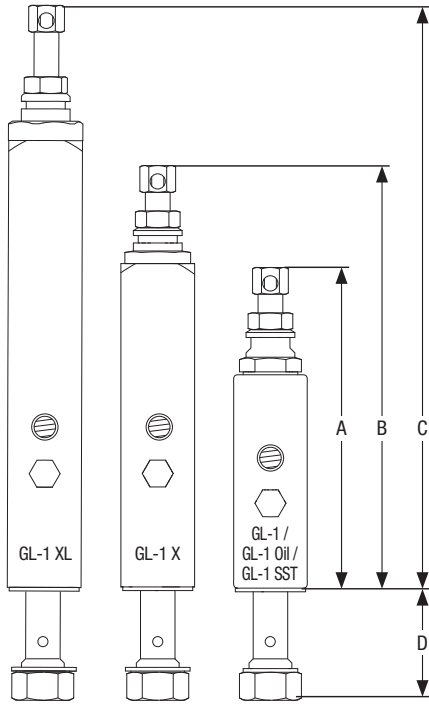

**GL-1 Injector Dimensions**

<b>A</b>	5.3 in (13.46 cm)
<b>B</b>	6.9 in (17.53 cm)
<b>C</b>	9.5 in (24.13 cm)
<b>D</b>	1.7 in (4.32 cm)

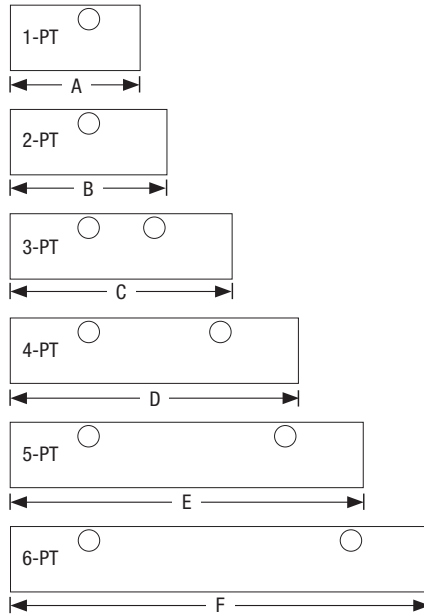

**GL-1 Manifold Dimensions**

<b>A</b>	2.5 in (6.35 cm)
<b>B</b>	3.0 in (7.62 cm)
<b>C</b>	4.2 in (10.67 cm)
<b>D</b>	5.5 in (13.97 cm)
<b>E</b>	6.7 in (17.02 cm)
<b>F</b>	8.0 in (20.32 cm)



114905



24X807

## Ordering Information

### GL-1 Injectors and Manifold Assemblies

	GL-1	GL-1 Oil	GL-1 SST	GL-1 X	GL-1 XL
GL-1 one point assembly	114901	25T641	–	24X801	24X811
GL-1 two point assembly	114902	25T642	–	24X802	24X812
GL-1 three point assembly	114903	25T643	–	24X803	24X813
GL-1 four point assembly	114904	25T644	–	24X804	24X814
GL-1 five point assembly	114905	25T645	–	24X805	24X815
GL-1 six point assembly	117206	25T646	–	24X806	24X816
GL-1 single replacement injector (no manifold)	114909	25T649	25N109	24X807	24X817

### GL-1 Bare Injector Manifolds (no injectors included)

One bank GL-1 manifold	114911	114911	25N101	114911	114911
Two bank GL-1 manifold	114912	114912	25N102	114912	114912
Three bank GL-1 manifold	114913	114913	25N103	114913	114913
Four bank GL-1 manifold	114914	114914	25N104	114914	114914
Five bank GL-1 manifold	114915	114915	25N105	114915	114915
Six bank GL-1 manifold	118206	118206	25N106	118206	118206



24X817

## Ordering Information

### GL-1 Injector Accessories

	GL-1	GL-1 SST	GL-1 X	GL-1 XL
Injector Cover Kit, polycarbonate	17L754	17L754	17L754*	17L755*
Injector Crossport Kit	133095	128139	133095	133095
Zerk and Cap Kit (5 pack)	17Y511	17Y498	17Y511	17Y511
Adjustment Screw and Lock Nut (5 pack)	17Y510	17Y489	–	–
Seal Repair Kit	241234	241234	25A081	25A080
GL-1 Oil Conversion Kit	25E349	25E349	–	–
Injector Port Manifold Plug	25D336	–	25D336	25D336

\*Included with every GL-1 X and GL-1 XL injector.

### GL-1 Manifold Mounting Weld Bar

One bank GL-1 manifold	17S392
Two bank GL-1 manifold	17S392
Three bank GL-1 manifold	17S393
Four bank GL-1 manifold	17S394
Five bank GL-1 manifold	17S395
Six bank GL-1 manifold	17S396

### Output Spectrum Sleeves

GL-1 Output Target in <sup>3</sup> (cm <sup>3</sup> )	Output Target Ratio		Color	10-Pack Part Number
	From Minimum	From Maximum		

#### GL-1 / GL-1 SST Injectors

0.01 (0.1)	1.0	0.10	N/A	N/A
0.03 (0.5)	2.0	0.50	Red	17K601
0.05 (0.8)	3.0	0.60	Silver	17K602
0.06 (1.0)	4.0	0.80	Gold	17K603
0.08 (1.3)	5.0	1.00	Green	17K604

#### GL-1 X Injectors

0.01 (0.3)	1.0	0.20	N/A	N/A
0.03 (0.5)	2.0	0.40	Red	17K601
0.04 (0.7)	3.0	0.50	Silver	17K602
0.06 (0.8)	3.3	0.60	Gold	17K603
0.07 (1.2)	5.0	0.75	Green	17K604

#### GL-1 XL Injectors

0.04 (0.6)	1.0	0.10	N/A	N/A
0.05 (0.8)	1.5	0.15	Red	17K601
0.06 (1.0)	2.1	0.25	Silver	17K602
0.09 (1.5)	2.8	0.30	Gold	17K603
0.12 (2.0)	3.4	0.40	Green	17K604
0.13 (2.0)	3.9	0.45	Black	17N453
0.15 (2.5)	4.3	0.50	Purple	17N454
0.18 (3.0)	5.4	0.60	Blue	17N455
0.21 (3.5)	6.4	0.75	Orange	17N456
0.24 (4.0)	7.5	0.90	Brown	17N457
0.30 (5.0)	8.6	1.00	Yellow	17N458



Single Line Parallel

# GL-11 Injectors

## High Volume Output at High Pressures for the Most Demanding Applications

Rugged, medium-pressure metering system for pumping grease; ideal for heavier-duty applications such as mobile mining vehicles, milling, cement batch plants or material processing equipment.

### Adjustable Output Volumes

To custom fit the system for each lube point.

### Convenient Top-Mounted Cycle Pin Indicator

Provides quick, at-a-glance confirmation that the injector is functioning properly.



24A918

### Hex-Head Adjustment

For easy turning from most any orientation.

#### Typical Applications

- Rugged, medium-pressure metering system for pumping grease; ideal for heavier-duty applications such as mobile mining vehicles, milling, cement batch plants or material processing equipment.

#### Typical Fluids

- Grease up to NLGI #2

#### Technical Specifications

Reset Pressure	600 psi (41 bar)
Maximum Pressure	3,500 psi (241 bar)
Suggested Operating Pressure	2,500 psi (172 bar)
Minimum Operating Pressure	1,000 psi (69 bar)
Output Range	0.05 to 0.5 in <sup>3</sup> (0.82 to 8.2 cm <sup>3</sup> )
Number of Adjustment Turns	14
Cycle Indicator	Visual
Instruction Manual	313704

## Ordering Information

### GL Injectors and Accessories

Part Number	Description
24A918	GL-11 Injector
24B359	GL-11 Injector Repair Kit
17Y511	GL-11 Zerk and Cap Kit (5 pack)

# Compact Series Progressive (CSP) Valves

## Graco Quality in a Compact Package

Compact Series Progressive (CSP) valve with broad-market versatility. Combine with field-proven Graco pumps for a complete system solution.

**1/8 in NPT or BSPP Inlet**

### Built-in Durability

Zinc iron plating stands up to harsh environments.



### Variety of Configurations

6 to 22 outlets, available with or without indicators.

### High Output Pressure

Maximum working pressure of 5,076 psi (350 bar).

### Output to Meet Your Needs

0.012 in<sup>3</sup> (0.2 cc)/stroke output with the ability to double-up outlets if greater output is required.

### Typical Applications

- Industrial or mobile applications where space is at a premium

### Typical Fluids

- Oil or grease up to NLGI #2

### Technical Specifications

Maximum Pressure, psi (bar)	5,076 (350)
Output Single Outlet	0.012 in <sup>3</sup> (0.20 cm <sup>3</sup> )
Cycle Indication	Electronic proximity switch, visual indicator
Max Operating Temperature	212°F (100°C)
Material	Carbon alloy steel with zinc iron plating
Instruction Manual	3A3995

## Ordering Information

### CSP Valves Without Cycle Pin

Number of Outlets	Inlet Port Thread	
	1/8 in NPT	1/8 in BSPP
6	24Z486	24Z477
8	24Z487	24Z478
10	24Z488	24Z479
12	24Z489	24Z480
14	24Z490	24Z481
16	24Z491	24Z482
18	24Z492	24Z483
20	24Z493	24Z484
22	24Z494	24Z485







### CSP Valves With Cycle Pin

Number of Outlets	Inlet Port Thread	
	1/8 in NPT	1/8 in BSPP
6	24Z504	24Z495
8	24Z505	24Z496
10	24Z506	24Z497
12	24Z507	24Z498
14	24Z508	24Z499
16	24Z509	24Z500
18	24Z510	24Z501
20	24Z511	24Z502
22	24Z512	24Z503

# Compact Series Progressive (CSP) Valves



## Ordering Information

### CSP Outlet Fittings

	Part Number	Description
	17Y692	1/4 in OD tube compression with check valve – for use with Nylon tubing
	17Y693	1/8 in NPT female thread with check valve
	17L440	1/4 in OD tube Push-to-Connect with check valve – for use with Nylon tubing
	17L441	1/4 in stud G-Lock Push-to-Connect – connects to G-Lock 1/4 in stud hose end fitting
	17L458	6 mm stud G-Lock Push-to-Connect – connects to hose with G-Lock 6 mm stud hose end fitting
	17L543	6 mm stud Push-to-Connect for nylon tubing
	17L550	6 mm stud compression fitting – connects to hose with 6 mm stud hose end fitting

Refer to page 207 for mating tubing, hose studs and hoses.

### CSP Valve Accessories

	Part Number	Description
	17L651	Output Doubling Plug – crossports/shunts flow to next outlet further from inlet
	17L879	Solid State Proximity Switch – for electronic cycle indication, 10-36 VDC PNP, M12 electrical connector
<i>Image Coming Soon</i>	17R703	M12 extension cable, 1 ft (30 cm) long. Connect to Solid State Prox Switches when installed on a CSP mounted directly to bottom of a G-Mini or G3 Max pump.
<i>Image Coming Soon</i>	17Y640	Replacement CSP piston enclosure plug
<i>Image Coming Soon</i>	25E935	Acrylic Demo Kit with pneumatic squeeze bulb, CSP-8 without Indicator
<i>Image Coming Soon</i>	25N730	Weld Bar Kit
<i>Image Coming Soon</i>	26A478	Weld Stud Kit
<i>Image Coming Soon</i>	26A479	Weld Stud Template

### CSP Compact Cycle Switches

New compact proximity switches mount to the cycle pin assembly on a CSP divider valve and provide electronic cycle indication to G3 and G-Mini pumps with built-in controllers, as well as most external controllers compatible with PNP sensors.

- Use with CSP divider valves with a cycle indicator pin
- LED light on each switch provides visual indication of cycles
- 10-30 VDC PNP, wires the same as other PNP switches
- Wiring diagram is included with each switch
- Rated IP67; UL, CE certified

	Part Number	Description
<i>Image Coming Soon</i>	26C822	Switch assembly with 9.5 in (24 cm) cable to M12 connector. Recommended for a divider valve mounted to the bottom of a G3 Max or SP, or G-Mini Controller pump.
<i>Image Coming Soon</i>	26C823	Switch assembly with 16.5 ft (5 m) cable to flying leads. Recommended for G-Series pumps with a remote mounted valve, and for GLC controllers. M12 connector 124594 (sold separately) is required when wiring to G-Series pumps.

## Compact Valve Solution

The Trabon MD Series is the most compact series progressive solution making it a perfect fit for tight-spaced applications.

**Available with 2, 3, 4 or 6 Outlets**

### Fluoroelastomer Seals

For high temperature applications or synthetic lubricants.



**Easy to Install**

On new or existing equipment.

### Typical Applications

- Industrial or mobile applications where space is at a premium

### Typical Fluids

- Oil or grease grades up to NLGI #2

### Technical Specifications

Material	Steel
Maximum Pressure	3,000 psi (207 bar)
Net Weight (approximate)	1 lb 8 oz (0.68 kg)
Max Operating Temperature	350°F (176°C)
Instruction Manual	312497

## Ordering Information

	Number of Outlets	Output per Outlet, in <sup>3</sup> (cm <sup>3</sup> )	Valve Only	Valve with Cycle Pin	Valve with Cycle Switch and Bracket Assembly
MD-2	2	0.040 (0.66)	562656	562653	563270
MD-3	3	Outlet 1 – 0.040 (0.66) Outlet 2 and 3 – 0.020 (0.33)	562657	562654	563271
MD-4	4	0.020 (0.33)	562658	562655	564356
MD-6	6	0.010 (0.16)	562659	N/A	

### MD Parts and Accessories

Part Number	Description
17M380	Solid State Proximity Switch – for electronic cycle indication, 10-36 VDC PNP, M12 Electrical Connector
563555	Cycle Indicator Spud assembly
557720	Cycle Indicator Pin (replacement only, not compatible with valves that don't already have the pin)
557781	Replacement SPDT Cycle Switch
122276	Viton O-ring

## Compact Yet Configurable

The Trabon MJ series features a compact and easily customizable design that can be tailor fit to meet a variety of specific lube requirements. Capable of handling grease grades up to NLGI #1.

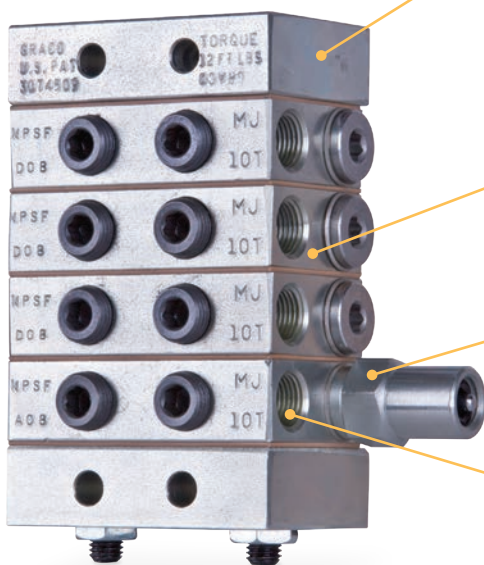

### Easily Accessorized

Can be easily accessorized with cycle and performance indicators to provide positive assurance of a successful lube event.

### Space Efficient

From 6 to 16 points from one block assembly.

### Built-In Outlet Check Valves

Ensure accurate lube delivery, every time.

### Output Options

Three different piston sizes, each offered as S (single) or T (twin) outlet valves, allow a variety of ratios without increasing the size of the valve assembly.

#### Typical Applications

- Machine tools
- Textile, glass and can machinery

#### Typical Fluids

- Oil or Grease up to NLGI #1

#### Technical Specifications

Material	Plated Steel
Maximum Pressure	2,000 psi (137.89 bar)
Max Operating Temperature	200°F (93°C)
Max Cycle Rate with Cycle Pin	60 cycles/minute
Instruction Manual	312497

## Steps to Build Your MJ Divider Valve System:

**A** Select Valve Working Sections

**B** Select Inlet and End Sections

**C** Select Tie Rods and Tie Rod Nuts

**D** Cross-port and Singling Bars

**E** Cycle Indicators and Proximity Switches

**F** Performance Indicators

**G** Mounting Bars

Choose from Optional Accessories

### A Ordering Information

#### Valve Working Sections

Standard 1/8 in NPSF outlet ports accept NPT fittings. Must be ordered in multiples of five.

Outlet Configuration	Description	Output Per Outlet, in <sup>3</sup> (cm <sup>3</sup> )	Part Number	
			Standard Section	With Cycle Pin
Single	MJ-5S	0.010 (0.16)	562500	N/A
	MJ-10S	0.020 (0.33)	562501	562508
	MJ-15S	0.030 (0.49)	562502	562509
Twin	MJ-5T	0.005 (0.08)	562503	N/A
	MJ-10T	0.010 (0.16)	562504	562510
	MJ-15T	0.015 (0.26)	562505	562511

#### MJ Spare Parts and Accessories

Part Number	Description
563948	Cycle Indicator Repair Kit
557514	Replacement Gasket
557349	Replacement Outlet Port Plug (one is already included with each "S" section)

### B Ordering Information

#### Inlet and End Sections

Must be ordered in multiples of five.

Component	Description	Part Number
Inlet Section	Standard 1/8 in NPSF inlet, accepts NPT fittings.	560643
End Section	Standard end section.	560645

Note: Each valve, inlet and end section is packaged with a gasket, so a complete MJ assembly will have one gasket leftover.

## C Ordering Information

### Tie Rods and Tie Rod Nuts

Two tie rods and two tie rod nuts required for each MJ assembly.

Component	Length	Part Number
Tie Rods	3-section	557515
	4-section	557516
	5-section	557517
	6-section	557518
	7-section	557519
	8-section	557520
Tie Rod Nuts	N/A	556371

## D Ordering Information

### Crossport and Singling Bars

For each bar used, order one of part number 557349 (1/8 in NPT pipe plug) to plug the unused outlet.

	Part Number	Component	Description
	562914	Right Crossport Bar	Provides a path to redirect output from one outlet to the next one below it, away from the inlet.
	562915	Singling Bar	Converts a "T" valve to an "S" valve.

## E Ordering Information

### Cycle Indicators and Proximity Switches

These switches sense the divider valve piston's action for accurate control and monitoring of lube cycles.

Part Number	Component	Description
563272	Single pole, double throw (SPDT) standard cycle switch and bracket assembly	Used in conjunction with the cycle indicator at cycle rates not exceeding 60 cpm, the switch provides an electrical signal to the system controller which counts cycles to monitor and verify completion of the lube cycle. Included bracket clamps to spud around cycle pin.
563273	Moisture-resistant SPDT cycle switch and bracket assembly	
564357	Double pole, double throw (DPDT) cycle switch and bracket assembly	
17M380	Solid State Proximity Switch (see page 161 for mating cables)	This rugged switch has no moving parts, making it ideal for applications such as metal stamping presses and yellow iron equipment. 10-32 VDC PNP switching, M12 electrical connector, 200 cpm, 3,000 PSI (207 bar) maximum pressure. 50,000,000 cycle life, IP65, IP68, IP69 rated.

**F** Ordering Information

**Performance Indicators**

These vital safeguards react to excess lube pressure when points or lines become blocked. Installed in indicator ports on the working piston sections, they quickly identify the affected lines. 1/8 in NPT male thread installs in the indicator ports on the front of each valve.

**Reset Indicators**

**Features and Benefits**

- Provides quick troubleshooting tool with visual indication
- No tools for reset or parts to replace after indication
- Easy information on blocked lines, high system pressure or blocked bearings

	Part Number	Indication Pressure
<i>Image Coming Soon</i>	563231	250 psi (17 bar)
	563232	500 psi (35 bar)
	563233	750 psi (52 bar)
	563234	1,000 psi (69 bar)
	563235	1,500 psi (103 bar)
	563236	2,000 psi (138 bar)

**Automatic Relief Indicators**

These performance indicators pinpoint lube line blockages but allow the lube system to continue to supply lubrication to points that are not blocked.

**Features and Benefits**

- Provides quick troubleshooting tool with visual indication
- No tools for reset or parts to replace after indication
- Easy information on blocked lines, high system pressure or blocked bearings

	Part Number	Indication Pressure
<i>Image Coming Soon</i>	563163	750 psi (52 bar)
	563164	1,000 psi (69 bar)
	563166	1,500 psi (103 bar)
	563167	2,000 psi (138 bar)

**G** Ordering Information

**Mounting Bar**

Part Number	Component	Description
561101	MJ Divider Valve Weld Bar	1/2 in (12.7 mm) thick steel bars are designed for welding to uneven metal surfaces. Tapped holes are provided for mounting the divider valves. This part is one individual bar, so order quantity 2 when needed.

# Trabon® MSP Divider Valve

## The Industry Standard for Quality and Reliability

The Trabon MSP Series sets the industry standard for quality, reliability and ease-of-use features. It was the original modular-style series progressive divider valve and is still the best!

### Baseplate Assemblies

Pre-assembled and tested base plates now available! Make your parts list shorter and assembly quicker.

### Easily Accessorized

Accessories such as cycle indicating proximity switches provide positive assurance of a successful lube event.

### Built-In Outlet Check Valves

Ensure accurate lube delivery, every time.

### Quick Change Valve Sections

Easily removed from the base assembly without disturbing any lube lines

### Indicator Ports

Alternate outlets on face of each valve can be fitted with optional performance indicators, taking the guesswork out of troubleshooting.

### Fluid Flexibility

Use the same MSP components for oil or grease applications, reducing the number of parts that need to be stocked.

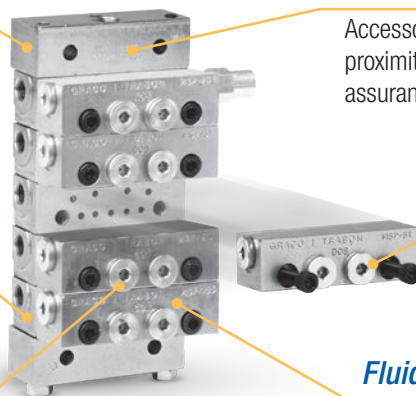

### Typical Applications

- Mobile, industrial, food and beverage, wind, and many more

### Typical Fluids

- Oil or Grease up to NLGI #2

### Technical Specifications

Material	Plated Steel
Maximum Pressure	3,500 psi (241 bar)
Max Operating Temperature	350°F (176 °C)
Max Cycle Rate with Cycle Pin	60 cycles/minute
Max Cycle Rate without Cycle Pin	200 cycles/minute
Instruction Manual	312497

## Steps to Build Your MSP Divider Valve System:

**A** Select the Base Plate Assembly By the Number of Valve Sections Needed

**B** Select Valve Working Sections

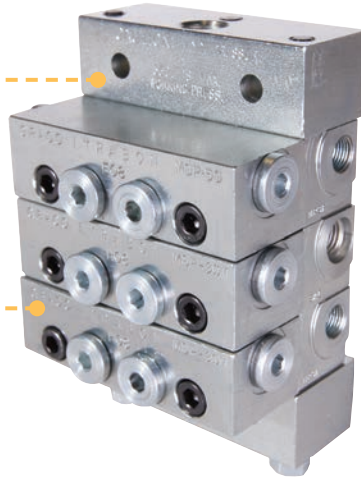

### Choose from Optional Accessories

- C** Cross-port and Singling Bars
- D** Performance Indicators
- E** Cycle Indicators and Proximity Switches
- F** Mounting Bars and Brackets
- G** Modular Specialty Inlets

## **A** Ordering Information

### Factory-Tested MSP Base Plate Assemblies

How many valve sections are in the assembly? Count up the number of sections and order a base assembly that has the correct number of sections. Base plate assembly is delivered completely assembled and tested with inlet, intermediate base plate sections, end section, tie rods and nuts.

Item	Maximum Number of Outlets	Number of Valve Sections	Part Number	
			NPSF	BSPP
1/2/3/4/5	6	3	24G485	24N915
	8	4	24G486	24N916
	10	5	24G487	24N917
	12	6	24G488	24N918
	14	7	24G489	24N919
	16	8	24G490	24N920

Series Progressive

## A Ordering Information (continued)

### Build Your Own MSP Base Plate Assemblies

Item	Component	Description	Part Number			Note	
			NPSF	BSPP	SAE-ORB		
1	Inlet section options See page 136 for Zero Leak and Shunt inlet section options	Standard "MS" inlet section	560919	560936	560943	Must be ordered in multiples of 5.	
		"MH" inlet with bleed ports	563421	N/A	563422		
2	Intermediate base plate	Two outlet ports	563425	563447	563451		
3	End section options	Standard end	563424				
		With alternate inlet port*	563279				
4	Tie Rods (3 required)	3-section	557731				3 tie rods and tie rod nuts required for assembly.
		4-section	557732				
		5-section	557733				
		6-section	557734				
		7-section	557735				
		8-section	557736				
		9-section	557738				
		10-section	557739				
11-section	557740						
5	Tie Rod Nuts (3 required)	Tie rod nuts	556371				

\*Alternate inlet port requires Leak Proof Zerk fitting such as part number 555888, 556429 or similar.

### Legend

1	Inlet Section
2	Intermediate Base Plate Section / Subplate
3	End Section
4	Tie Rod
5	Tie Rod Nut
6	MSP Valve Section
7	Outlet Port Plug
8	Cross-port or Singling Bar
9	Performance Indicator

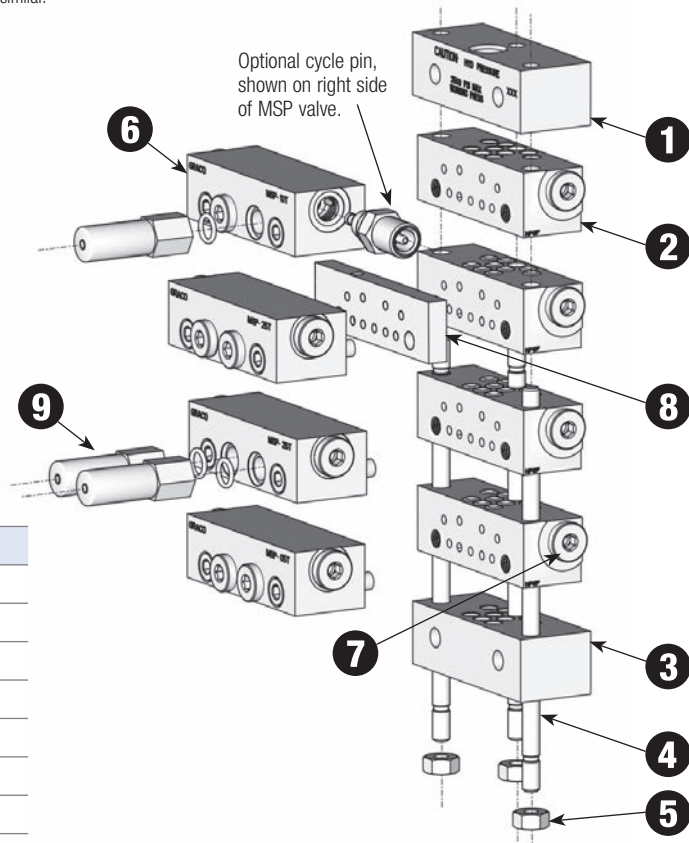

### MSP Section Spare Parts

Part Number	Description
122276*	Standard O-ring (90 DURO Fluoroelastomer), black
556540*	Alternate O-ring (70 DURO Buna-N), black
557721*	MSV O-ring (70 DURO Fluoroelastomer), brown
563929	Cycle Indicator Pin Repair Kit
556327	Outlet Check Ball
557508	Outlet Check Spring, NPSF and BSPP bases
556994	Outlet Check Spring, SAE-ORB bases

\*Part numbers are for a single O-ring; each section requires nine O-rings.

**B** Ordering Information

**MSP Valve Sections**

Also called “Working” sections. Must be ordered in multiples of 5.

Outlet Configuration	Description	Output Per Outlet, in <sup>3</sup> (cm <sup>3</sup> )	Part Number	
			Standard Section	With Cycle Pin
Single	MSP-5S*	0.010 (0.16)	562711	N/A
	MSP-10S*	0.020 (0.33)	562712	
	MSP-15S*	0.030 (0.49)	562713	
	MSP-20S*	0.040 (0.66)	562714	562729
	MSP-25S*	0.050 (0.82)	562715	562730
	MSP-30S*	0.060 (0.98)	562716	562731
	MSP-35S*	0.070 (1.15)	562717	562732
	MSP-40S*	0.080 (1.31)	562718	562733
Twin	MSP-5T	0.005 (0.08)	562720	N/A
	MSP-10T	0.010 (0.16)	562721	
	MSP-15T	0.015 (0.26)	562722	
	MSP-20T	0.020 (0.33)	562723	562739
	MSP-25T	0.025 (0.41)	562724	562740
	MSP-30T	0.030 (0.49)	562725	562741
	MSP-35T	0.035 (0.57)	562726	562742
	MSP-40T	0.040 (0.66)	562727	562743

\*Each “S” section uses only one outlet, but each intermediate base has two outlets. For each “S” section in the assembly, order one Outlet Port Plug (below), to plug the unused outlet.

**Outlet Port Plugs**

Part Number			Note
NPSF	BSPF	SAE-ORB	
557349 (NPT)	558799 (with seal ring)	567251 (with O-ring)	1 outlet port plug is required for each “S” valve section.

**Bypass Section**

Part Number	Description
562660	MSP-BP Bypass Block takes the place of a valve, but has no output. Not a true working section. Requires two outlet port plugs for the unused outlets.

**C** Ordering Information

**Cross-port and Singling Bars**

Part Number	Component	Note
563469	Right Cross-port Bar	1 outlet port plug is required for each cross-port bar, to plug the unused outlet.
563470	Left Cross-port Bar	
563471	Right and Left Cross-port Bar	2 outlet port plugs are required for each double cross-port bar.
563472	Singling Bar	Converts a “T” valve to an “S” valve.

## D

### Ordering Information

#### Performance Indicators

These vital safeguards react to excess lube pressure when points or lines become blocked. Installed in indicator ports on the working piston sections, they quickly identify the affected lines.

#### Reset Indicators with Memory

##### Features and Benefits

- Provides quick troubleshooting tool with visual indication
- No tools for reset or parts to replace after indication
- Easy information on blocked lines, high system pressure or blocked bearings
- 1/8 in NPSF thread with O-ring seal

<i>Image Coming Soon</i>	Part Number	Cracking Pressure
	563252	250 psi (17 bar)
	563253	500 psi (35 bar)
	563254	750 psi (52 bar)
	563255	1,000 psi (69 bar)
	563256	1,500 psi (103 bar)
	563257	2,000 psi (138 bar)
	563258	2,500 psi (172 bar)
	563261	3,000 psi (207 bar)
	563263	3,500 psi (241 bar)

#### Automatic Relief Indicators

##### Features and Benefits

These performance indicators pinpoint lube line blockages but allow the lube system to continue to supply lubrication to points that are not blocked.

- Allows machine to continue to run when non-critical bearings are blocked
- No time or effort required for reset after blockage is cleared
- Easy information on blocked lines, high system pressure or blocked bearings
- 1/8 in NPSF thread with O-ring seal

	Part Number	Cracking Pressure
	563170	750 psi (52 bar)
	563171	1,000 psi (69 bar)
	563172	1,250 psi (86 bar)
	563173	1,500 psi (103 bar)
	563174	2,000 psi (138 bar)
	563175	2,500 psi (172 bar)
	563176	3,000 psi (207 bar)



#### Performance Indicator Spare Parts

Part Number	Description
556569	Standard O-ring (90 DURO Fluoroelastomer), black
556567	Alternate O-ring (90 DURO Buna-N), black
16U217	Indicator Port Plug, with O-ring 556569

**E** Ordering Information

**Cycle Indicators and Proximity Switches**

A wide variety of safeguards to monitor and verify lube cycles. These mechanical and electrical units sense the divider valve piston's action for accurate control and monitoring of lube cycles.

	Part Number	Component	Description
	563251	Magnetic Visual Cycle Indicator	The highly visible cycle indicator has a snap-action movement which allows the user to visually determine the timing of each divider valve cycle.
	563272	SPDT Cycle Switch, provides electrical signal to controller or PLC	Used in conjunction with the cycle indicator pin at cycle rates not exceeding 60 cpm, it provides an electrical signal to the system controller which counts cycles to monitor and verify completion of the lube cycle.
	564357	Double Pole, Double Throw (DPDT) Cycle Switch and bracket assembly	
<i>Image Coming Soon</i>	563273	SPDT Cycle Switch, provides electrical signal to controller or PLC, moisture resistant	
	17L983	Solid State Proximity Switch (see page 161 for mating cables)	This rugged switch has no moving parts, making it ideal for applications such as metal stamping presses and yellow iron equipment. 10-32 VDC PNP switching, M12 electrical connector, 200 cpm, 7,500 PSI (518 bar) maximum pressure. 50,000,000 cycle life, IP65, IP68, IP69 rated.
<i>Image Coming Soon</i>	557741	Field-Sensitive Proximity Switch, 3-Pin BH, with O-ring	A ceramic-magnet switch for grease or oil systems up to 200 cpm at pressure up to 3,500 psi (241 bar), accurately signals piston cycles, and is ideal for high-cycle applications. Bradley-Harrison (BH) electrical connectors, 115 VAC. 7/16-20 thread with O-ring seal mates to MSP valves with date codes L94 and newer.
	557746	Field-Sensitive Proximity Switch, 5-Pin BH, with O-ring	

**Proximity Switch Spare Parts**

Part Number	Component
556570	Standard O-ring (90 DURO Fluoroelastomer), black
556568	Alternate O-ring (90 DURO Buna-N), black
567251	Enclosure Port Plug, with O-ring 556570

**F** Ordering Information

**Mounting Bars**

Part Number	Component	Description
560920	MSP/MHH Weld Bar	1/2 in (12.7 mm) thick steel bars are designed for welding to uneven metal surfaces. Mounting holes are threaded 1/4-20 to attach MSP or MHH valve assembly.
17J423	MSP/MHH Weld Stud Fixture	Attach studs to the jig before welding to ensure perfect alignment. For 3-valve to 8-valve assemblies
563465	Divider Valve Weld Bar Kit	Includes 2 mounting bars (560920), 4 screws, washers and lockwashers.

Series Progressive



## Ordering Information

### MSP Modular Specialty Inlets

#### Shunt Inlets

**NEW** – Graco has updated the Shunt Valve power connection to a DIN Connector. Previous versions used a 3-Pin Brad Harrison Connector. Adapter kit 25T585 (see below) is available to convert from 3-Pin BH to DIN.

#### Features and Benefits

- For use with oil and FLUID grease only – 3,500 psi maximum fluid pressure
- A three-way valve, incorporated into the MSP inlet section – can replace standard inlet or mount in-line with remote manifold kit.
- Options for 115 VAC, 24 VDC or pneumatic
- “Normal” state allows lubricant to enter divider valve
- Energized state sends fluid out the bypass port – to another divider valve, to a large bearing or back to tank.

Image Coming Soon	Power	Connection	Normal State	Shunt Inlet Part Number			Replacement Solenoids**
				Connection Thread			
				NPSF	BSPP	SAE-ORB	
	115 VAC	DIN	NO	25B534	–	25U054	20A339
	115 VAC	DIN	NC	25B535	–	25U053	
	24 VDC	DIN	NO	25B515	25U041	25U052	20A081
	24 VDC	DIN	NC	25B514	25U040	25U051	
	Pneumatic	1/8 NPSF*	NC*	563456	–	–	–

\*Pneumatic Shunt 563456 ships in Normally Closed configuration, can be converted to Normally Open in the field. Air pressure range 40 to 150 psi, 1/8 in NPSF female air inlet port.

\*\*Replacement Solenoids will NOT work in the old-style Shunt Inlets. If the coil or solenoid in an old style Inlet section has failed, replace the entire Inlet section.

#### Zero-Leak Shut-Off Inlets

**NEW** – Graco has updated the Zero-Leak Shut-Off Valve power connection to a DIN Connector. Previous versions used a 3-Pin Brad Harrison Connector. Adapter kit 25T585 (see below) is available to convert from 3-Pin BH to DIN.

#### Features and Benefits

- For use with oil only – 1,500 psi maximum oil pressure
- A two-way valve that can be used with either continuous or intermittent pressurized header systems.
- Replaces a standard inlet section or mounts in-line with a remote manifold kit.
- All models are Normally Closed

Image Coming Soon	Power	Connection	Normal State	Zero Leak Inlet Part Number			Replacement Solenoids**
				Connection Thread			
				NPSF	BSPP	SAE-ORB	
	115 VAC	DIN	NC	20A900	–	20A901	20A586
	24 VDC	DIN	NC	20A903	20A902	20A904	20A585
	Inlet restrictor with 90 micron last chance filter			563074	–	–	–

\*\*Replacement Solenoids will NOT work in the old-style Zero-Leak Shut-Off Inlets. If the coil or solenoid in an old style Inlet section has failed, replace the entire Inlet section.

### Other Components for Shunt and Zero-Leak Shut-Off Inlets

#### Connector and Cable Options

	Part Number	Description
	16U790	Power cable with DIN connector, 15 ft (4.5 m).
	132924	Field-installable DIN connector, no wire provided.
	25T585	Adapter Cable Kit, 3-Pin BH to DIN. To be used on retrofits. Some assembly required. Instruction Manual number 3A8068.

#### Remote Mount Manifold Kit

Part Number	Description
563461	Includes manifold with 1/4 NPSF outlet, O-ring 556540 and two mounting screws.

## Setting the Industry Standard for Quality, Reliability and Ease-of-Use Features

More durability with the same high-quality performance and precision machining as the carbon steel version. The stainless steel MSP valves and accessories overcome harsh conditions, such as salty air or areas needing repetitive cleaning, with durable 303 materials and a design with proven success.

### Baseplate Assemblies

Pre-assembled and tested base plates now available! Make your parts list shorter and assembly quicker.

### Easily Accessorized

Accessories such as proximity switch cycle indicators provide positive assurance of a successful lube event.

### Built-In Outlet Check Valves

Ensure accurate lube delivery, every time.

### Quick Change Valve Sections

Easily removed from the base assembly without disturbing any lube lines

### Indicator Ports

Alternate outlets on face of each valve can be fitted with optional performance indicators, taking the guesswork out of troubleshooting.

### Fluid Flexibility

Use the same MSP components for oil or grease applications, reducing the number of parts that need to be stocked.

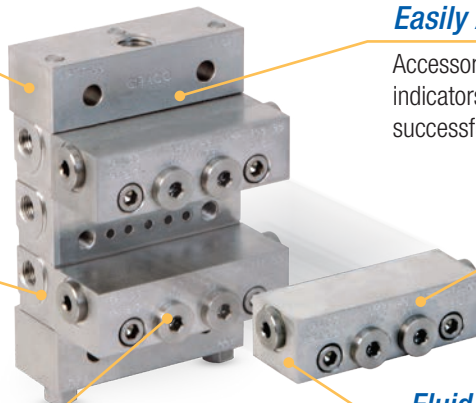

### Typical Applications

- Food and beverage, machine tools, textile, glass and can machinery, mobile equipment

### Typical Fluids

- Oil or Grease up to NLGI #2

### Technical Specifications

External Material	Stainless Steel
Internal Material	Carbon Steel
Maximum Pressure	3,500 psi (241 bar)
Max Operating Temperature	140°F (60°C)
Max Cycle Rate without Cycle Pin	200 cycles/minute
Instruction Manual	312497

## Steps to Build Your MSP Stainless Steel Divider Valve System:

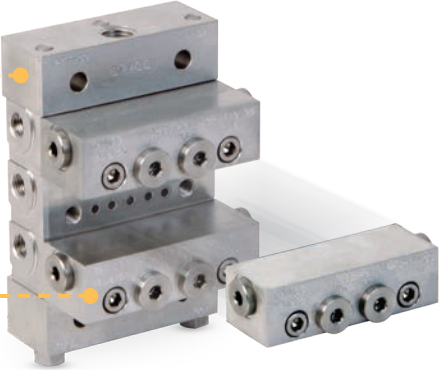

**A** Select the Base Plate Assembly By the Number of Valve Sections Needed

**B** Select Valve Working Sections

Choose from Optional Accessories

**C** Cross-port and Singling Bars

**D** Performance Indicators

**E** Cycle Indicators and Proximity Switches

### A Ordering Information

#### Factory-Tested MSP Base Plate Assemblies

How many valve sections are in the assembly? Count up the number of sections and order a base assembly that has the correct number of sections. Base plate assembly is delivered completely assembled and tested with inlets, intermediate base plate sections, end section, tie rods and nuts.

Item	Maximum Number of Outlets	Number of Valve Sections	Part Number	
			NPSF	BSPP
1/2/3/4/5	6	3	24N382	24N388
	8	4	24N383	24N389
	10	5	24N384	24N390
	12	6	24N385	24N391
	14	7	24N386	24N392

## A Ordering Information (continued)

### Build Your Own MSP Base Plate Assemblies

Item	Component	Description	Part Number		Note
			NPSF	BSPF	
1	303 stainless steel inlet section		15Y070	16P368	Must be ordered in multiples of 5
2	303 stainless steel intermediate base plate – with two outlet ports		24B497	24N369	
3	303 stainless steel end section		24B498		
4	416 stainless steel tie rods (3 required)	3-section	126247		3 tie rods and tie rod nuts required for assembly
		4-section	126248		
		5-section	126249		
		6-section	126250		
		7-section	126251		
5	Tie rod nuts (3 required)	Tie rod nuts	558633		

### Legend

1	Inlet Section
2	Intermediate Base Section / Subplate
3	End Section
4	Tie Rod
5	Tie Rod Nut
6	MSP Valve Section
7	Outlet Port Plug
8	Cross-port or Singling Bar
9	Performance Indicator

### MSP Section Spare Parts

Part Number	Description
122276*	Standard O-ring (90 DURO Fluoroelastomer), black
556540*	Alternate O-ring (70 DURO Buna-N), black
556327	Outlet Check Ball
557508	Outlet Check Spring

\*Part numbers are for a single O-ring; each section requires nine O-rings.

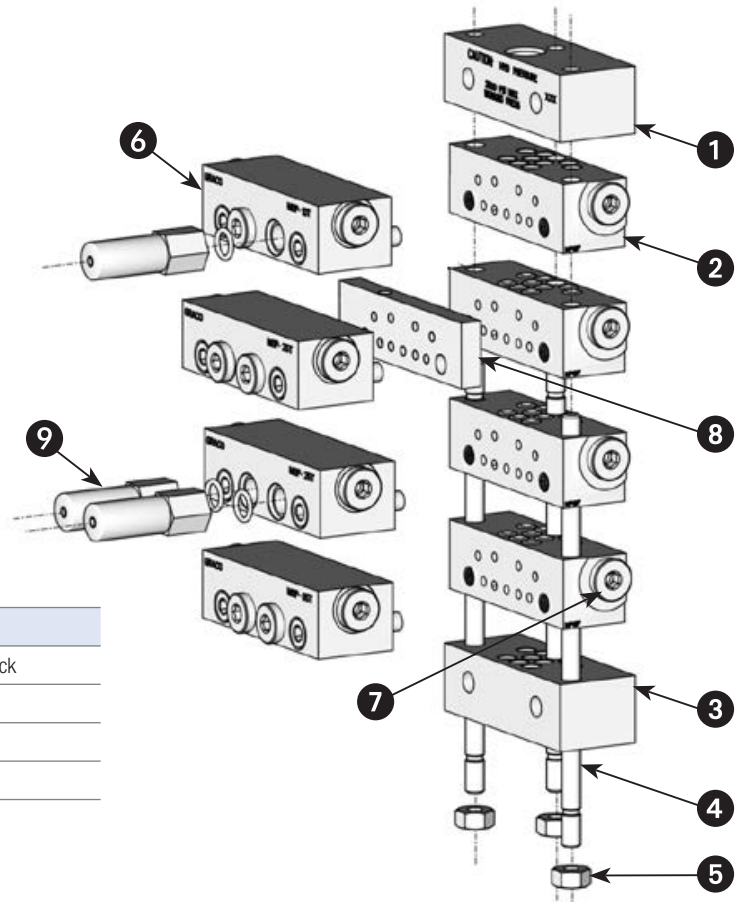

## B Ordering Information

### MSP Valve Sections – 303 Stainless Steel

Also called “Working” sections. Must be ordered in multiples of 5.

Outlet Configuration	Description	Output Per Outlet, in <sup>3</sup> (cm <sup>3</sup> )	Part Number
			Standard Section
Single	MSP-5S*	0.010 (0.16)	24B474
	MSP-10S*	0.020 (0.33)	562755
	MSP-15S*	0.030 (0.49)	24B475
	MSP-20S*	0.040 (0.66)	562756
	MSP-25S*	0.050 (0.82)	24B476
	MSP-30S*	0.060 (0.98)	24B477
	MSP-35S*	0.070 (1.15)	24B478
	MSP-40S*	0.080 (1.31)	562757
Twin	MSP-5T	0.005 (0.08)	24B479
	MSP-10T	0.010 (0.16)	562758
	MSP-15T	0.015 (0.26)	24B480
	MSP-20T	0.020 (0.33)	562759
	MSP-25T	0.025 (0.41)	24B481
	MSP-30T	0.030 (0.49)	24B482
	MSP-35T	0.035 (0.57)	24B483
	MSP-40T	0.040 (0.66)	562760

### 316 Stainless Steel Outlet Port Plugs

Part Number		Note
NPSF	BSPP	
555457 (NPT)	114172 (BSPT)	1 outlet port plug is required for each “S” valve section

## C Ordering Information

### Cross-port and Singling Bars – 303 Stainless Steel

Part Number	Component	Note
24R632	Right Cross-port Bar	1 outlet port plug is required for each cross-port bar
24R633	Left Cross-port Bar	
24R631	Right and Left Cross-port Bar	2 outlet port plugs are required for each double cross-port bar

## D Ordering Information

### Performance Indicators

These vital safeguards react to excess lube pressure when points or lines become blocked. Installed in indicator ports on the working piston sections, they quickly identify the affected lines.

### Reset Indicators with Memory

#### Features and Benefits

- Provides quick troubleshooting tool with visual indication
- No tools for reset or parts to replace after indication
- Easy information on blocked lines, high system pressure or blocked bearings
- 1/8 NPSF thread with O-ring seal
- 303 Stainless Steel

	Part Number	Cracking Pressure
Image Coming Soon	24B495	1,000 psi (69 bar)
	24B496	1,500 psi (103 bar)
	24N373	2,000 psi (138 bar)

### Automatic Relief Indicators

#### Features and Benefits

These performance indicators pinpoint lube line blockages but allow the lube system to continue to supply lubrication to points that are not blocked.

- Allows machine to continue to run when non-critical bearings are blocked
- No time or effort required for reset after blockage is cleared
- Easy information on blocked lines, high system pressure or blocked bearings
- 1/8 NPSF thread with O-ring seal
- 303 Stainless Steel

	Part Number	Cracking Pressure
	24N945	1,000 psi (69 bar)
	24N948	1,500 psi (103 bar)
	24N949	2,000 psi (138 bar)
	24N951	2,500 psi (172 bar)
	24N952	3,000 psi (207 bar)

### Performance Indicator Spare Parts

Part Number	Description
556569	Standard O-ring (90 DURO Fluoroelastomer), black
556567	Alternate O-ring (90 DURO Buna-N), black
19B227	Indicator Port Plug, 303 stainless steel with O-ring 556569

## E

### Ordering Information

#### Cycle Indicators and Proximity Switches

A wide variety of safeguards to monitor and verify lube cycles. These mechanical and electrical units sense the divider valve piston's action for accurate control and monitoring of lube cycles.

	Part Number	Component	Description
	563251	Magnetic Visual Cycle Indicator	The highly visible cycle indicator has a snap-action movement which allows the user to visually determine the timing of each divider valve cycle.
	17L983	Solid State Proximity Switch (see page 161 for mating cables)	This rugged switch has no moving parts, making it ideal for applications such as metal stamping presses and yellow iron equipment. 10-32 VDC PNP switching, M12 electrical connector, 200 cpm, 7,500 PSI (518 bar) maximum pressure. 50,000,000 cycle life, IP65, IP68, IP69 rated.
	557741	Field-Sensitive Proximity Switch, 3-Pin BH, with O-ring	A ceramic-magnet switch for grease or oil systems up to 200 cpm at pressure up to 3,500 psi (241 bar), accurately signals piston cycles, and is ideal for high-cycle applications. Bradley-Harrison (BH) electrical connectors, 115 VAC.
	557746	Field-Sensitive Proximity Switch, 5-Pin BH, with O-ring	A ceramic-magnet switch for grease or oil systems up to 200 cpm at pressure up to 3,500 psi (241 bar), accurately signals piston cycles, and is ideal for high-cycle applications. Bradley-Harrison (BH) electrical connectors, 115 VAC.

#### Proximity Switch Spare Parts

Part Number	Component
556570	Standard O-ring (90 DURO Fluoroelastomer), black
556568	Alternate O-ring (90 DURO Buna-N), black
19A574	Enclosure Port Plug, 303 stainless steel with O-ring 556570

## Modular Design for Easy Maintenance

Same capable design as the Trabon MSP Series with even tighter and more exacting tolerances. The Manzel MHH Series delivers highly accurate lube delivery for demanding high-pressure oil applications.

### Baseplate Assemblies

Pre-assembled and tested base plates now available! Make your parts list shorter and assembly quicker.

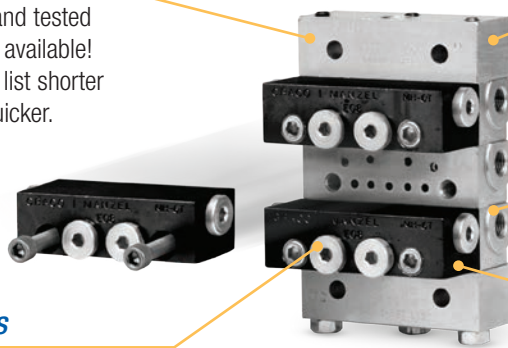

### Easily Accessorized

Accessories such as proximity switch cycle indicators provide positive assurance of a successful lube event.

### Built-In Outlet Check Valves

Ensure accurate lube delivery, every time.

### Quick Change Valve Sections

Easily removed from the base assembly without disturbing any lube lines – minimizing labor cost and maximizing your machine uptime.

### Indicator Ports

Alternate outlets on face of each valve can be fitted with optional performance indicators, taking the guesswork out of troubleshooting.

### Typical Applications

- Compressors, industrial equipment, and where high-pressure lubrication is required

### Typical Fluids

- Synthetic or Mineral Oil

### Technical Specifications

Material	Plated Steel
Maximum Pressure	7,500 psi (517 bar)
Maximum Operating Temperature	350°F (176°C)
Maximum Cycle Rate	200 cycles/min
Instruction Manual	312497

## Steps to Build Your MHH Divider Valve System:

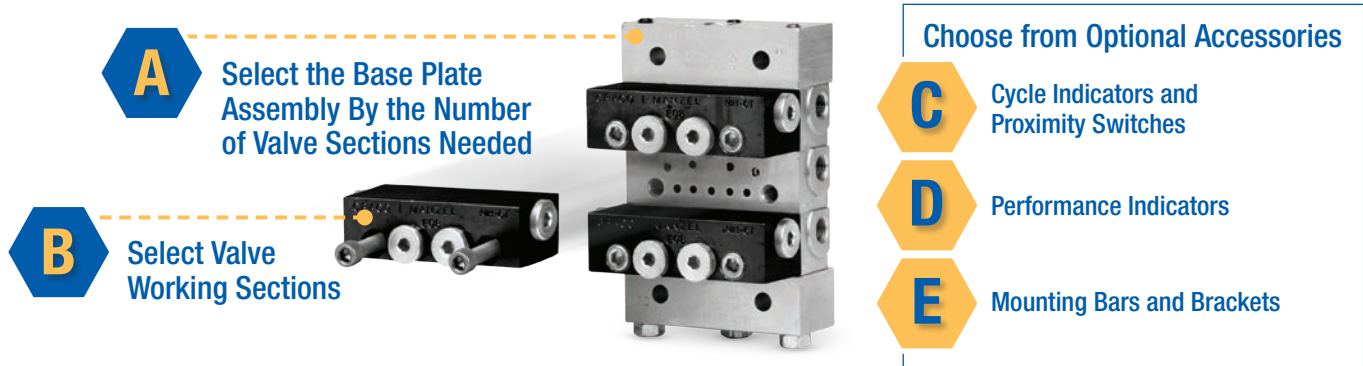

## A Ordering Information

### Factory-Tested MHH Base Plate Assemblies

How many sections are in the assembly? Count up the number of sections, and order a base assembly that has the correct number of sections. Base plate assembly is delivered completely assembled and tested with inlets, intermediate base plate sections, end section, tie rods and nuts.

Item	Maximum Number of Outlets	Number of Valve Sections	Part Number
			NPSF
1/2/3/4/5	6	3	24F596
	8	4	24F597
	10	5	24F598
	12	6	24F599
	14	7	24F600
	16	8	24F601

**A** Ordering Information (continued)

**Build Your Own MHH Base Plate Assemblies**

Item	Component	Description	Part Number	Note	
			NPSF		
1	Inlet section options	"MH" inlet with bleed ports	563421	Must be ordered in multiples of 5	
		"MS" inlet without bleed ports	560919		
2	Intermediate base plate	Two outlet ports	563425		
3	End section options plate	Standard end	563424		
		With alternate inlet port*	563279		
4	Tie Rods (3 required)	3-section	557731		3 tie rods and tie rod nuts required for assembly
		4-section	557732		
		5-section	557733		
		6-section	557734		
		7-section	557735		
		8-section	557736		
		9-section	557738		
		10-section	557739		
		11-section	557740		
5	Tie Rod Nuts (3 required)	Tie rod nuts	556371		

\*Alternate inlet port in end section 563279 requires Leak Proof Zerk fitting such as part number 555888, 556429 or similar.  
NOTE: Refer to MSP pages for BSPP and SAE inlet and base plate porting options.

**Legend**

1	Inlet Section
2	Intermediate Base Section / Subplate
3	End Section
4	Tie Rod
5	Tie Rod Nut
6	MSP Valve Section
7	Outlet Port Plug
9	Performance Indicator

**MHH Section Spare Parts**

Part Number	Description
122276*	Standard O-ring (90 DURO Fluoroelastomer), black
556540*	Alternate O-ring (70 DURO Buna-N), black
556327	Outlet check ball
557508	Outlet check spring

\*Part numbers are for a single O-ring; each section requires nine O-rings.

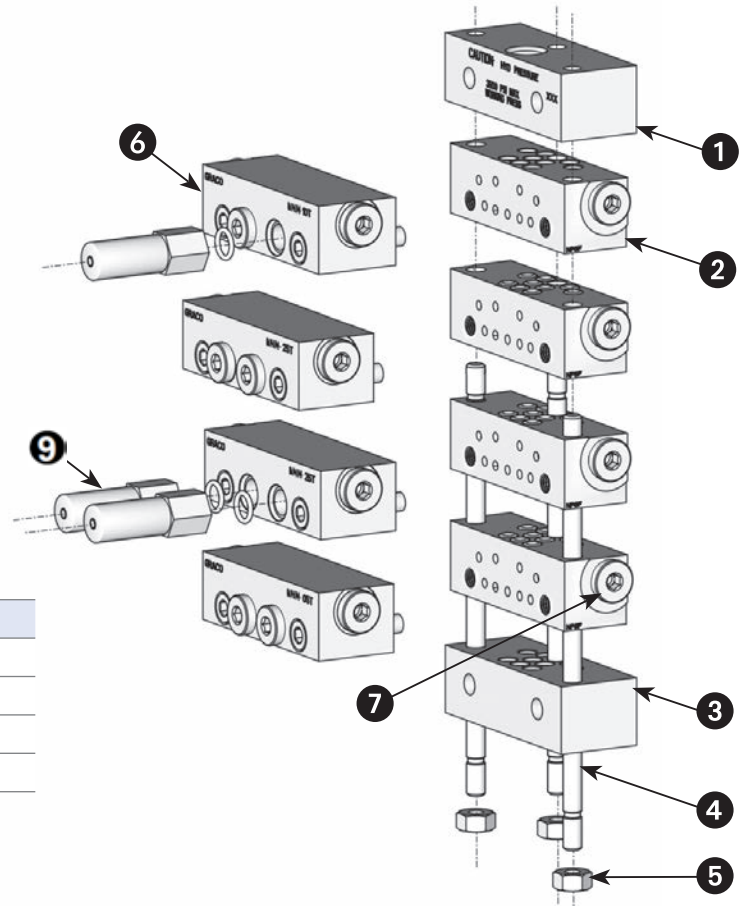

## B Ordering Information

### MHH Valve Sections

Also called "Working" sections. Must be ordered in multiples of 5.

Outlet Configuration	Description	Output Per Outlet, in <sup>3</sup> (cm <sup>3</sup> )	Part Number
			Standard Section
Single	MHH-6S*	0.012 (0.197)	562679
	MHH-9S*	0.018 (0.295)	562680
	MHH-12S*	0.024 (0.393)	562681
	MHH-15S*	0.030 (0.492)	24X029
	MHH-18S*	0.036 (0.590)	562682
	MHH-21S*	0.042 (0.688)	24X030
	MHH-24S*	0.048 (0.787)	562683
	MHH-30S*	0.060 (0.983)	562684
Twin	MHH-6T	0.006 (0.098)	562685
	MHH-9T	0.009 (0.149)	562686
	MHH-12T	0.012 (0.197)	562687
	MHH-15T	0.015 (0.246)	24X027
	MHH-18T	0.018 (0.295)	562688
	MHH-21T	0.021 (.0344)	24X028
	MHH-24T	0.024 (0.393)	562689
	MHH-30T	0.030 (0.492)	562690

\*Each "S" section uses only one outlet, but each intermediate base has two outlets. For each "S" section in the assembly, order one of part number 557349 (1/8 in NPTF Outlet Port Plug) to plug the unused outlet.

## C Ordering Information

### Cycle Indicators and Proximity Switches

	Part Number	Component	Note
	563251	Magnetic Visual Cycle Indicator	The highly visible cycle indicator has a snap-action movement which allows the user to visually determine the timing of each divider valve cycle.
<i>Image Coming Soon</i>	557745	Explosion-Proof FSmech Proximity Switch	Explosion-proof dry contact switch dual rated for 115 VAC or 10-32 VDC. Includes potted 6 ft (1.8 m) cable with flying leads. Used at pressures that do not exceed 7,500 psi (517 bar) at cycle rates up to 200 cycles per minute. Approved for hazardous locations: Class I, Groups A, B, C and D – Division 1.
<i>Image Coming Soon</i>	558941	Micro-Monitor	LCD shows total cycle count up to 999,999. Reset to zero by inserting the reset magnet into the recessed opening. An LED will also flash with each cycle of the piston in the divider block indicating a complete stroke.

### Proximity Switch Spare Parts

Part Number	Component
556570	Standard O-ring (90 DURO Fluoroelastomer), black
556568	Alternate O-ring (90 DURO Buna-N), black
567251	Enclosure Port Plug, with O-ring 556570

**D** Ordering Information

**Performance Indicators**

These vital safeguards react to excess lube pressure when points or lines become blocked. Installed in indicator ports on the working piston sections, they quickly identify the affected lines.

**Reset Indicators with Memory**

**Features and Benefits**

- Provides quick troubleshooting tool with visual indication
- No tools for reset or parts to replace after indication
- Easy information on blocked lines, high system pressure or blocked bearings
- 1/8 NPSF thread with O-ring seal

<i>Image Coming Soon</i>	Part Number	Cracking Pressure
	563258	2,500 psi (172 bar)
	563261	3,000 psi (207 bar)
	563263	3,500 psi (241 bar)
	563262	5,000 psi (345 bar)

**Disk-Type Pressure Indicator**

**Features and Benefits**

A blow-out disk ruptures when lube line blockage occurs and lubricant forces a pin to protrude from the body of the indicator. There is no provision for relief and the pressure escalates until relieved elsewhere in the system. The disk must be replaced and the pin reset manually after the blockage is eliminated.

- Easy information on blocked lines, high system pressure or blocked bearings
- 1/8 NPSF thread with O-ring seal

	Part Number	Cracking Pressure	Replacement Rupture Disks
	563229	2,800 psi (193 bar)	557422
	563221	3,700 psi (255 bar)	557423
	563222	4,600 psi (317 bar)	557424
	563224	5,500 psi (380 bar)	557425
	563226	6,400 psi (441 bar)	557427
	N/A	7,300 psi (503 bar)	557428
	N/A	8,200 psi (565 bar)	557429

**Performance Indicator Spare Parts**

Part Number	Description
556569	Standard O-ring (90 DURO Fluoroelastomer), black
556567	Alternate O-ring (90 DURO Buna-N), black
16U217	Indicator Port Plug, with O-ring 556569

**E** Ordering Information

“Manzel Mount” MHH valves have the same footprint as the Trabon MSP valves. Please refer to the MSP pages for mounting bar and bracket options available from Graco.

Series Progressive

## Greater Output Volumes for Heavy Service Requirements

The Trabon MX Series is ideal for steel and paper mill systems with its economical and compact design.

### Durable Design

Withstands harsh environments and operating conditions.

### Indicator Ports

Alternate outlets on face of each valve can be fitted with optional performance indicators, taking the guesswork out of troubleshooting.

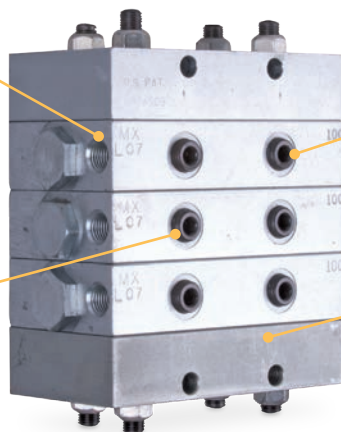

### Easily Accessorized

Accessories such as proximity switch cycle indicators provide positive assurance of a successful lube event.

### Built-In Outlet Check Valves

Ensure accurate lube delivery, every time.

### Typical Applications

- Pulp and paper, steel mills, heavy- and high-volume industrial applications
- **Please Note:** MX valves are primarily offered for replacement of existing MX, MXS, and MXO valve assemblies. For new application, consider the MXP series instead.

### Typical Fluids

- Oil or Grease up to NLGI #2

### Technical Specifications

Material	Plated Steel
Maximum Pressure	3,000 psi (207 bar)
Maximum Operating Temperature	200°F (93°C)
Maximum Cycle Rate with Cycle Pin	60 cycles/min
Instruction Manual	312497

**Steps to Build Your MX Divider Valve System:**

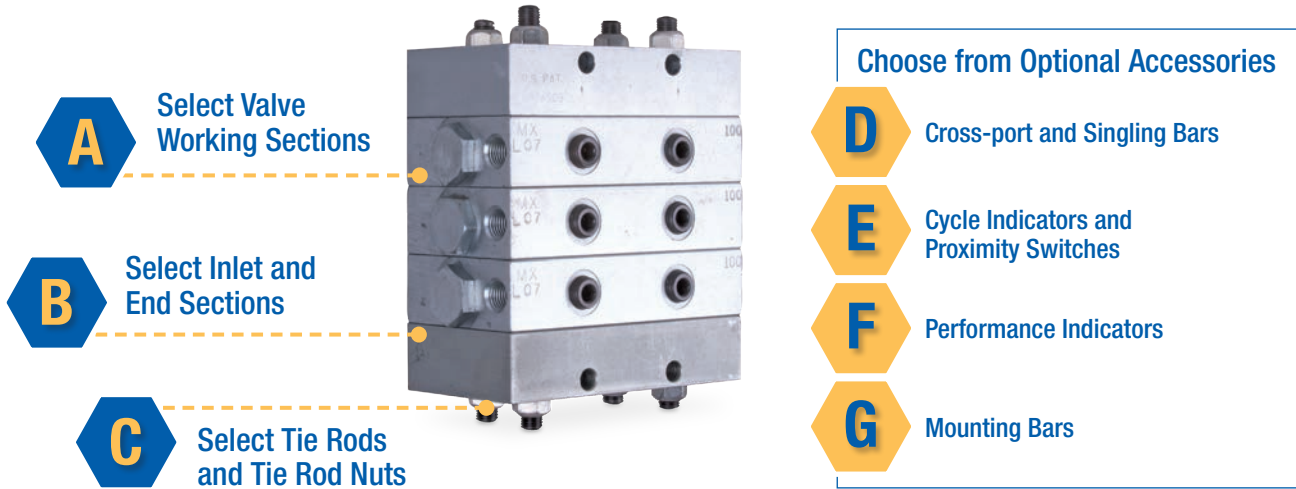

**A** Ordering Information

**Valve Working Sections**

Must be ordered in multiples of two.

Outlet Configuration	Description	Output Per Outlet, in <sup>3</sup> (cm <sup>3</sup> )	Part Number		
			Standard Section	With Cycle Pin – Right	With Cycle Pin – Left
Single	MX-25S	0.050 (0.82)	562514	N/A	
	MX-50S	0.100 (1.64)	562516	562518	562528
	MX-75S	0.150 (2.46)	562538	562519	562529
	MX-100S	0.200 (3.28)	562540	562520	562530
	MX-125S	0.250 (4.10)	562542	562521	562531
	MX-150S	0.300 (4.92)	562545	562522	562532
Twin	MX-25T	0.025 (0.41)	562515	N/A	
	MX-50T	0.050 (0.82)	562517	562523	562533
	MX-75T	0.075 (1.23)	562539	562524	562534
	MX-100T	0.100 (1.64)	562541	562525	562569
	MX-125T	0.125 (2.05)	562543	562526	562535
	MX-150T	0.150 (2.46)	562546	562527	562536

**MX Spare Parts and Accessories**

Part Number	Description
563917	Cycle indicator repair kit
557509	Replacement intermediate gasket
557391	Replacement 1/4 in NPTF outlet port plug (one is already included with each "S" section)

**B** Ordering Information

**Inlet and End Sections**

Must be ordered in multiples of two.

Component	Description	Part Number
Inlet Section	Standard 3/8 in NPSF inlet, accepts NPT fittings	560620
End Section	Standard end section	563287

Note: Each valve, inlet and end section is packaged with a gasket, so a complete MX assembly will have one gasket leftover.

Series Progressive

## C Ordering Information

### Tie Rods and Tie Rod Nuts

Four tie rods and eight tie rod nuts required for each MX assembly.

Component	Length	Part Number
Tie Rods (4 required)	3-section	557488
	4-section	557489
	5-section	557490
	6-section	557491
	7-section	557492
	8-section	557493
	9-section	560576
Tie Rod Nuts (8 required)	N/A	557494

## D Ordering Information

### Cross-port and Singling Bars

For each bar used, order one of part number 557391 (1/4 in NPT pipe plug) to plug the unused outlet.



Part Number	Component	Description
562917	Right or Left Cross-port Bar	Provides a path to redirect output from one outlet to the next one below it, away from the inlet.
562916	Singling Bar	Converts a "T" valve to an "S" valve

## E Ordering Information

### Cycle Indicators and Proximity Switches

A wide variety of safeguards monitor and verify lube cycles. These switches sense the divider valve piston's action for accurate control and monitoring of lube cycles.



Part Number	Component	Description
563260	Magnetic Visual Cycle Indicator	The highly visible cycle indicator has a snap-action movement which allows the user to visually determine the timing of each divider valve cycle.
563272	Single Pole, Double Throw (SPDT) Standard Cycle Switch and Bracket Assembly	Used in conjunction with the cycle indicator pin at cycle rates not exceeding 60 cpm, the switch provides an electrical signal to the system controller which counts cycles to monitor and verify completion of the lube cycle. Included bracket clamps to spud around cycle pin.
563273	Moisture-resistant SPDT Cycle Switch and Bracket Assembly	
564357	Double Pole, Double Throw (DPDT) Cycle Switch and Bracket Assembly	This rugged switch has no moving parts, making it ideal for applications such as metal stamping presses and yellow iron equipment. 10-32 VDC PNP switching, M12 electrical connector, 200 cpm, 7,500 PSI (518 bar) maximum pressure. 50,000,000 cycle life, IP65, IP68, IP69 rated.
17L880	Solid State Proximity Switch (see page 161 for mating cables)	
563476	Field-Sensitive Proximity Switch, 3-Pin BH, with O-ring	A ceramic-magnet switch for grease or oil systems up to 200 cpm at pressure up to 3,500 psi (241 bar), accurately signals piston cycles, and is ideal for high-cycle applications. Bradley-Harrison (BH) electrical connectors, 115 VAC.
564399	Field-Sensitive Proximity Switch, 5-Pin BH, with O-ring	

**F** Ordering Information

**Performance Indicators**

These vital safeguards react to excess lube pressure when points or lines become blocked. Installed in indicator ports on the working piston sections, they quickly identify the affected lines. 1/4 in NPT male thread installs in the indicator ports on the front of each valve.

**Reset Indicators with Memory**

**Features and Benefits**

- Provides quick troubleshooting tool with visual indication
- No tools for reset or parts to replace after indication
- Easy information on blocked lines, high system pressure or blocked bearings
- 1/4 in NPTF thread

	Part Number	Indication Pressure
	563239	250 psi (17 bar)
	563240	500 psi (35 bar)
	563241	750 psi (52 bar)
	563242	1,000 psi (69 bar)
	563243	1,500 psi (103 bar)
	563244	2,000 psi (138 bar)
	563245	2,500 psi (172 bar)

**Automatic Relief Indicators**

These performance indicators pinpoint lube line blockages but allow the lube system to continue to supply lubrication to points that are not blocked.

**Features and Benefits**

- Allows machine to continue to run while non-critical bearings are lubricated
- No time or effort required for reset after blockage is cleared
- Easy information on blocked lines, high system pressure or blocked bearings
- 1/4 in NPTF thread

	Part Number	Indication Pressure
	563156	750 psi (52 bar)
	563157	1,000 psi (69 bar)
	563158	1,250 psi (86 bar)
	563159	1,500 psi (103 bar)
	563160	2,000 psi (138 bar)
	563161	3,000 psi (207 bar)

**G** Ordering Information

**Mounting Bars**

Part Number	Component	Description
561102	MX/MXP Mounting Bar	For welding to uneven metal surfaces. Two sets of mounting holes are threaded 5/16-18 to attach MXP or MX. This part is one individual bar, so order quantity 2 when needed.

Series Progressive

## Modular Version Of MX Valves — Same Function, But Modern Design.

The “big brother” of the MSP. Uses same performance indicators as MSP!

### Built-In Outlet Check Valves

Ensure accurate lube delivery, every time.

### Indicator Ports

Alternate outlets on face of each valve can be fitted with optional performance indicators, taking the guesswork out of troubleshooting.

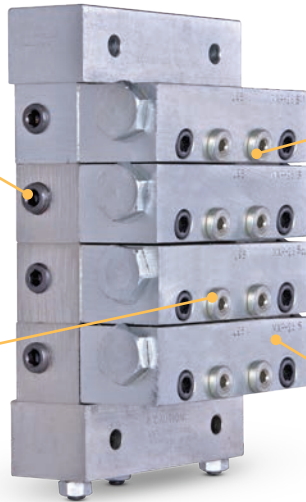

### Easily Accessorized

Accessories such as proximity switch cycle indicators provide positive assurance of a successful lube event.

### Quick Change Valve Sections

Easily removed from the base assembly without disturbing any lube lines.

### Typical Applications

- Pulp and paper, steel mills, heavy- and high-volume industrial applications

### Typical Fluids

- Oil or Grease up to NLGI #2

### Technical Specifications

Material	Plated Steel
Maximum Pressure	3,000 psi (207 bar)
Maximum Operating Temperature	350°F (176°C)
Maximum Cycle Rate with Cycle Pin	60 cycles/min
Maximum Cycle Rate without Cycle Pin	110-200 cycles/min (see chart below)
Instruction Manual	312497

### MXP Maximum Cycle Rates without Cycle Pin (cycles/min)

		Number of Sections							
		3	4	5	6	7	8	9	10
Smallest Piston in the Assembly	MXP-150	200	200	200	200	200	200	180	165
	MXP-125	200	200	200	200	200	195	175	155
	MXP-100	200	200	200	200	200	185	165	150
	MXP-75	200	200	200	200	200	175	155	140
	MXP-50	200	200	200	200	195	165	145	130
	MXP-25	200	200	200	200	165	140	125	120

## Steps to Build Your MXP Divider Valve System:



**A** Build Your Base Plate Assembly From the Chart Below

**B** Select Valve Working Sections

**Choose from Optional Accessories**

- C** Cross-port and Singling Bars
- D** Performance Indicators
- E** Cycle Indicators and Proximity Switches
- F** Mounting Bars

### A Ordering Information

#### Build Your Own MXP Base Plate Assemblies

How many sections are in the assembly? This includes working sections and bypass blocks. Count up the number of sections and order at least one Intermediate Base Plate for each section. Then add one Inlet and one End section. Finally choose the correct tie rods and order three of them and also three nuts.

Item	Component	Description	Part Number			Note
			NPSF	BSPP	SAE-ORB	
1	Inlet section option	Includes one threaded port	15R993 (3/8-18)	561029 (3/8-19)	15R994 (3/4-16)	
2	Intermediate base plate	Standard base with outlet checks	563519 (1/4-18)	563522 (1/4-19)	563521 (9/16-18)	Must be ordered in multiples of 5
		"MXPO" base, no outlet checks	563527	24Z675	N/A	
3	End section options	Standard	563518			
4	Tie rods (3 required)	3-section	557766			3 tie rods and tie rod nuts required for assembly
		4-section	557767			
		5-section	557768			
		6-section	557769			
		7-section	557770			
		8-section	557771			
		9-section	557772			
10-section	563520					
5	Tie rod nuts (3 required)	Tie rod nuts	555406			

#### Legend

1	Inlet Section
2	Intermediate Base Section / Subplate
3	End Section
4	Tie Rod
5	Tie Rod Nut
6	MXP Valve Section
7	Outlet Port Plug
8	Cross-port or Singling Bar
9	Performance Indicator

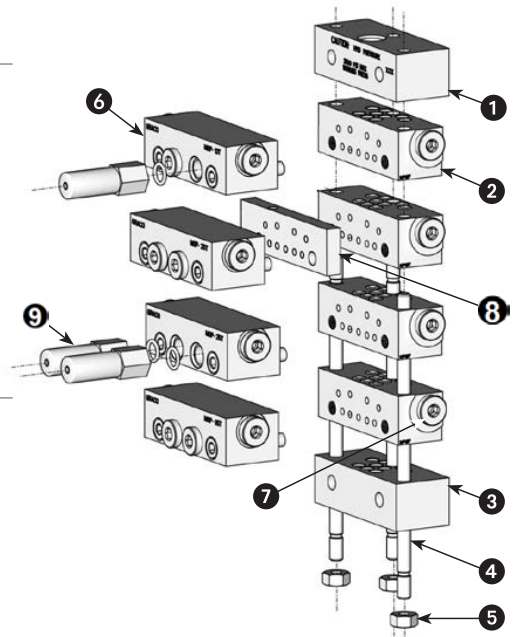

#### MXP Section Spare Parts

Part Number	Description
115010*	Standard O-ring (90 DURO Fluoroelastomer), black
563917	Cycle indicator pin repair kit
556328	Outlet check ball
557484	Outlet check spring, NPSF and BSPP bases
556997	Outlet check spring, SAE-ORB bases

\*Part numbers are for a single O-ring; each section requires nine O-rings.

## B Ordering Information

### MXP Valve Sections

Also called “working” sections. Must be ordered in multiples of 2.

Outlet Configuration	Description	Output Per Outlet, in <sup>3</sup> (cm <sup>3</sup> )	Part Number	
			Standard Section	With Cycle Pin – Right
Single	MXP-25S*	0.050 (0.82)	562819	N/A
	MXP-50S*	0.100 (1.64)	562820	562830
	MXP-75S*	0.150 (2.46)	562821	562831
	MXP-100S*	0.200 (3.28)	562822	562832
	MXP-125S*	0.250 (4.10)	562823	562833
	MXP-150S*	0.300 (4.92)	562824	562834
Twin	MXP-25T	0.025 (0.41)	562813	N/A
	MXP-50T	0.050 (0.82)	562814	562825
	MXP-75T	0.075 (1.23)	562815	562826
	MXP-100T	0.100 (1.64)	562816	562827
	MXP-125T	0.125 (2.05)	562817	562828
	MXP-150T	0.150 (2.46)	562818	562829

\*Each “S” section uses only one outlet, but each intermediate base has two outlets. For each “S” section in the assembly, order one Outlet Port Plug (below), to plug the unused outlet.

### Outlet Port Plugs

Part Number		Note
NPSF	BSPP	
557391 (NPT)	556427 (with seal ring)	1 outlet port plug is required for each “S” valve section.

## C Ordering Information

### Cross-port and Singling Bars

Part Number	Component	Note
563525	Right Cross-port Bar	1 outlet port plug is required for each cross-port bar
563524	Left Cross-port Bar	
563526	Right and Left Cross-port Bar	2 outlet port plugs are required for each double cross-port bar

**D** Ordering Information

**Performance Indicators**

These vital safeguards react to excess lube pressure when points or lines become blocked. Installed in indicator ports on the working piston sections, they quickly identify the affected lines.

**Reset Indicators with Memory**

**Features and Benefits**

- Provides quick troubleshooting tool with visual indication
- No tools for reset or parts to replace after indication
- Easy information on blocked lines, high system pressure or blocked bearings
- 1/8 NPSF thread with O-ring seal

<i>Image Coming Soon</i>	Part Number	Cracking Pressure
	563252	250 psi (17 bar)
	563253	500 psi (35 bar)
	563254	750 psi (52 bar)
	563255	1,000 psi (69 bar)
	563256	1,500 psi (103 bar)
	563257	2,000 psi (138 bar)
	563258	2,500 psi (172 bar)
	563261	3,000 psi (207 bar)

**Automatic Relief Indicators**

**Features and Benefits**

These performance indicators pinpoint lube line blockages but allow the lube system to continue to supply lubrication to points that are not blocked.

- Allows machine to continue to run when non-critical bearings are blocked
- No time or effort required for reset after blockage is cleared
- Easy information on blocked lines, high system pressure or blocked bearings
- 1/8 NPSF thread with O-ring seal

	Part Number	Cracking Pressure
	563170	750 psi (52 bar)
	563171	1,000 psi (69 bar)
	563172	1,250 psi (86 bar)
	563173	1,500 psi (103 bar)
	563174	2,000 psi (138 bar)
	563175	2,500 psi (172 bar)
	563176	3,000 psi (207 bar)

**Performance Indicator Spare Parts**

Part Number	Description
556569	Standard O-ring (90 DURO Fluoroelastomer), black
16U217	Indicator Port Plug, with O-ring 556569

Series Progressive

## E Ordering Information

### Cycle Indicators and Proximity Switches

A wide variety of safeguards monitor and verify lube cycles. These switches sense the divider valve piston's action for accurate control and monitoring of lube cycles.

	Part Number	Component	Description
	563260	Magnetic Visual Cycle Indicator	The highly visible cycle indicator has a snap-action movement which allows the user to visually determine the timing of each divider valve cycle.
	563272	Single Pole, Double Throw (SPDT) Standard Cycle Switch and Bracket Assembly	Used in conjunction with the cycle indicator pin at cycle rates not exceeding 60 cpm, the switch provides an electrical signal to the system controller which counts cycles to monitor and verify completion of the lube cycle. Included bracket clamps to spud around cycle pin.
	563273	Moisture-resistant SPDT Cycle Switch and Bracket Assembly	
	564357	Double Pole, Double Throw (DPDT) Cycle Switch and Bracket Assembly	
	17L880	Solid State Proximity Switch (see page 161 for mating cables)	This rugged switch has no moving parts, making it ideal for applications such as metal stamping presses and yellow iron equipment. 10-32 VDC PNP switching, M12 electrical connector, 200 cpm, 7,500 PSI (518 bar) maximum pressure. 50,000,000 cycle life, IP65, IP68, IP69 rated.
	563476	Field-Sensitive Proximity Switch, 3-Pin BH, with O-ring	A ceramic-magnet switch for grease or oil systems up to 200 cpm at pressure up to 3,500 psi (241 bar), accurately signals piston cycles, and is ideal for high-cycle applications. Bradley-Harrison (BH) electrical connectors, 115 VAC.
	564399	Field-Sensitive Proximity Switch, 5-Pin BH, with O-ring	

### Proximity Switch Spare Parts

Part Number	Component
556572	Standard O-ring (90 DURO Fluoroelastomer), black
557774	Enclosure Port Plug, requires O-ring 556572 (not included)

## F Ordering Information

### Mounting Bars

Part Number	Component	Description
561102	MXP/MX Mounting Bar	For welding to uneven metal surfaces. Two sets of mounting holes are threaded 5/16-18 to attach MXP or MX. This part is one individual bar, so order quantity 2 when needed.

## Offers The Largest Output Available In A Series Progressive System

Ideal for heavy-duty and large bearing applications with wide temperature variations and high volume requirements. Can be easily accessorized with magnetic and electronic proximity switch cycle indicators to provide positive assurance of a successful lube event.

### Indicator Ports

Alternate outlets on face of each valve can be fitted with optional performance indicators, taking the guesswork out of troubleshooting.

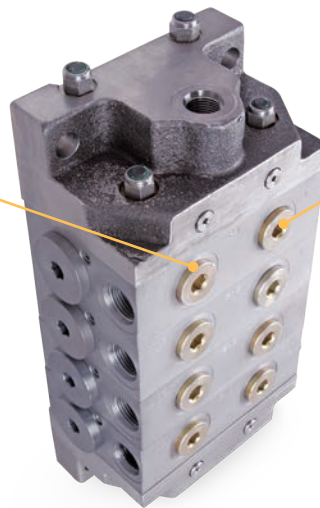

### Robust Design

Is virtually indestructible and built to perform in extreme environments.

### Typical Applications

- Pulp and paper, steel mills, heavy- and high-volume industrial applications

### Typical Fluids

- Oil or Grease up to NLGI #2

### Technical Specifications

Material	Plated Steel
Maximum Pressure	6,000 psi (413 bar)
Maximum Operating Temperature	350°F (176°C)
Maximum Cycle Rate with Cycle Pin	60 cycles/min
Maximum Cycle Rate without Cycle Pin	110-200 cycles/min (see chart below)
Instruction Manual	312497

### MGO Maximum Cycle Rates without Cycle Pin (cycles/min)

		Number of Sections							
		3	4	5	6	7	8	9	10
Smallest Piston in the Assembly	MGO-600	185	140	110	90	80	70	60	55
	MGO-450	185	135	110	90	75	65	60	50
	MGO-300	180	130	100	80	70	60	55	50
	MGO-150	180	125	100	80	65	55	50	45
	MXP-50	200	200	200	200	195	165	145	130
	MXP-25	200	200	200	200	165	140	125	120

## Steps to Build Your MGO Divider Valve System:

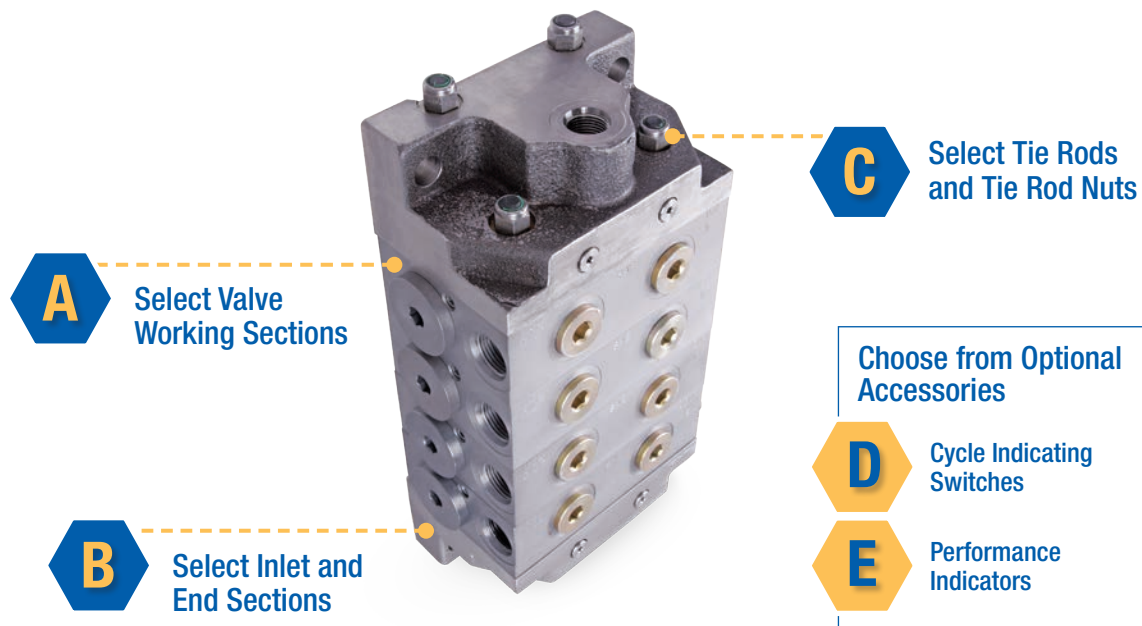

### A Ordering Information

#### Valve Working Sections

Standard 7/8 in-14 SAE-ORB outlet ports.

Outlet Configuration	Description	Output Per Outlet, in <sup>3</sup> (cm <sup>3</sup> )	Part Number	
			Standard Section	With Cycle Pin – Right
Single	MGO-150S	0.300 (4.92)	562570	562578
	MGO-300S	0.600 (9.83)	562571	562579
	MGO-450S	0.900 (14.7)	562572	562580
	MGO-600S	1.200 (19.7)	562573	562581
Twin	MGO-150T	0.150 (2.46)	562574	562582
	MGO-300T	0.300 (4.92)	562575	562583
	MGO-450T	0.450 (7.37)	562576	562584
	MGO-600T	0.600 (9.83)	562577	562585

#### MGO Spare Parts and Accessories

Part Number	Cracking Pressure
563926	Replacement MGO section O-ring kit – 1 kit per section
556424	Replacement 7/8 in-14 SAE-ORB outlet port plug, with O-ring (one is already included with each "S" section)

**B** Ordering Information

**Inlet and End Sections**

Component	Description	Part Number
Inlet Section	Standard 7/8-14 SAE-ORB inlet	563277
End Section	Standard end section	563278

**C** Ordering Information

**Tie Rods and Tie Rod Nuts**

Four tie rods and eight tie rod nuts required for each MGO assembly.

Component	Length	Part Number
Short Tie Rods (2 required)	3-section	560591
	4-section	560592
	5-section	560593
	6-section	560594
	7-section	560595
	8-section	560596
	9-section	560597
Long Tie Rods (2 required)	3-section	560600
	4-section	560601
	5-section	560602
	6-section	560603
	7-section	15U857
	8-section	560604
	9-section	560605
Tie Rod Nuts (8 required)	N/A	557494

Series Progressive

**D** Ordering Information

**Cycle Indicating Switches**

A wide variety of safeguards monitor and verify lube cycles. These switches sense the divider valve piston's action for accurate control and monitoring of lube cycles.

	Part Number	Component	Description
	563269	SPDT Cycle Switch, provides electrical signal to controller or PLC	Used in conjunction with the cycle indicator pin at cycle rates not exceeding 60 cpm, it provides an electrical signal to the system controller which counts cycles to monitor and verify completion of the lube cycle.
	17L881	Solid State Proximity Switch (see page 161 for mating cables)	This rugged switch has no moving parts, making it ideal for applications such as metal stamping presses and yellow iron equipment. 10-32 VDC PNP switching, M12 electrical connector, 200 cpm, 6,000 PSI (518 bar) maximum pressure. 50,000,000 cycle life, IP65, IP68, IP69 rated.
	563970	Field-Sensitive Proximity Switch, 3-Pin BH, with O-ring, 3,500 psi (241 bar) maximum	A ceramic-magnet switch for grease or oil systems up to 200 cpm, accurately signals piston cycles, and is ideal for high-cycle applications. Bradley-Harrison (BH) electrical connectors, 115 VAC.
	564402	Field-Sensitive Proximity Switch, 5-Pin BH, with O-ring, 10,000 psi (690 bar) maximum	

## E

### Ordering Information

#### Performance Indicators

These vital safeguards react to excess lube pressure when points or lines become blocked. Installed in indicator ports on the working piston sections, they quickly identify the affected lines.

#### Reset Indicators with Memory

##### Features and Benefits

- Provides quick troubleshooting tool with visual indication
- No tools for reset or parts to replace after indication
- Easy information on blocked lines, high system pressure or blocked bearings
- 7/8 in-14 SAE-ORB thread, with O-ring

	Part Number	Cracking Pressure
<i>Image Coming Soon</i>	564200	1,500 psi (103 bar)

## Solid State PNP Proximity Switches

Solid State switches use a transistor instead of moving parts, making them the most durable option. They are the first choice for all applications that run on DC power. Note: all G3 Max pumps run DC power on their cycle switches, even when the pumps are AC powered.

### Options for All Graco Trabon Valves

Mating threads for all valves including MSP, CSP and even MJ and MD!

### Stainless Steel Construction

IP65, IP68 and IP69 rated.

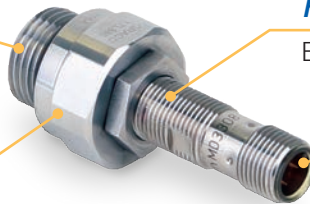

### PNP Transistor

Eliminates moving parts for maximum durability.

### M12 Electrical Connector

Mating cables are readily available with options for LED indication and NPN conversion.

### Typical Applications

- Cycle Indication for Series Progressive Divider Valves
- Metal stamping, construction equipment, nearly any application with a Series Progressive Divider Valve
- A great match to the G3 Max and G-Mini Controller pumps

### Typical Fluids

- Oil or Grease up to NLGI #2

### Technical Specifications

Material	Stainless Steel
Operating Voltage	9.6 - 32 VDC
Electrical Design	DC PNP
Max Operating Temperature	176°F (80 °C)
Switch state	Normally Open
Rated Life Cycles	50,000,000
Maximum Cycles per Minute	200
Approval or Classification	IP65, IP68, IP69
Instruction Manual	3A41444

## Ordering Information

### Solid State Proximity Switches

Part Number	Divider Valve Series	Maximum Pressure PSI (bar)
17L879	CSP	5,075 (350)
17M380	MD or MJ	3,000 (207)
17L983	MSP or MHH	7,500 (518)
17L880	MX or MXP	8,000 (552)
17L881	MG0	6,000 (414)

### Adapter Cables

Convert M12 to the various connections that have traditionally been offered on Trabon proximity switches. See Instruction Manual number 3A4481 for more information on adapter cables.

Part Number	Notes
24Z714	M12 to 5-pin BH cable also converts signal from PNP to NPN.
24Z715	M12 to 3-pin BH cable also converts signal from PNP to NPN.
24Z719	M12 to 4-pin CH cable; signal remains PNP

### M12 Wiring Harnesses

Part Number	Proximity Switch Connection	2nd Connection	Length	Note
For use with a G3 Max when connecting directly to the pump, when LED is required.				
25M602	M12 female, straight	Flying leads	16.5 ft (5 m)	PNP switch with NPN LED – requires 124594
25M603	M12 female, straight	M12 male, straight	16.5 ft (5 m)	PNP switch with NPN LED
For use with a G-Mini, a PLC or an external lubrication controller, when LED is required.				
25M604	M12 female, straight	Flying leads	16.5 ft (5 m)	-
24Z720	M12 female, 90°		16.5 ft (5 m)	
26A782	M12 female, 90°		33 ft (10 m)	

### Other M12 Cables, Without LED Indication

Part Number	Proximity Switch Connection	2nd Connection	Length	Note
126331	M12 female, straight	Flying lead	16.5 ft (5 m)	Requires 124594 when used with G3 Max or G-Mini
124300	Flying leads	M12 male, straight	16.5 ft (5 m)	Requires 124301 when used with solid state proximity switch
124333	M12 female, straight		16.5 ft (5 m)	
131214	M12 female, 90°		3.3 ft (1 m)	
131215			6.6 ft (2 m)	
131216			9.8 ft (3 m)	
130282			3.3 ft (1 m)	
130280	M12 female, straight		6.6 ft (2 m)	
130283			9.8 ft (3 m)	

# Proximity Switches

## FSM Cycle Indicating Proximity Switches

The Field-Sensitive Magnetic proximity switch is a dry contact magnetically actuated switch. Recent design improvements allow for reliable operation with AC and DC power. For metal stamping applications and other high-shock locations, use the Solid State proximity switches instead.

### Stainless Steel Construction

Pressure ratings up to 8,000 PSI (552 bar).

### Options for Most Graco Trabon Valves

Mating threads for valves including MSP, MXP and MGO.

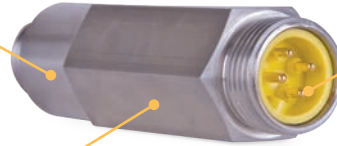

### Electrical Connector

Mating cables are readily available with options for LED indication (DC only) and NPN conversion.

#### Typical Applications

- Cycle Indication for Series Progressive Divider Valves

#### Typical Fluids

- Oil or Grease up to NLGI #2

#### Technical Specifications

Material	Stainless Steel
Operating Voltage	110 to 240 VAC, 24 VDC
Switch State	Normally Open
Rated Life Cycle	50,000,000+
Maximum Cycles Per Minute	125
Approval or Classification	UL & CSA
Instruction Manuals	313228, 313229, 313230, 3A0884

## Ordering Information

### FSM Proximity Switches

Part Number	Electrical Connector	Maximum Pressure PSI (bar)	Instruction Manual
-------------	----------------------	----------------------------	--------------------

#### MSP or MHH

557741	3-pin BH	3,500 (241)	313228
557745	Pigtail**,†	7,500 (518)	313228
557746	5-pin BH	3,500 (241)	313228
557747	4-pin CH	3,500 (241)	313230

#### MX or MXP

557752	4-pin CH	8,000 (552)	313229
558938	5-pin BH	8,000 (552)	313229
563476*	3-pin BH	3,500 (241)	313228
564399	5-pin BH	3,500 (241)	313228

#### MGO

563970	3-pin BH	3,500 (241)	313228
563495	4-pin CH	8,000 (552)	313229
564402	5-pin BH	8,000 (552)	313229

\*For gasket-seal MX and MX0 valves, use part number 563969 instead of 563476

\*\*Includes 6 ft, 3 conductor cable

†UL and CSA approved for hazardous locations: Class I, Groups A, B, C and D – Division 1; Class II, Groups E, F and G – Division 1

BH = Brad Harrison 7/8"

CH = Crouse-Hinds 7/8"

### FSM Wiring Harnesses

Part Number	Proximity Switch Connection	2nd Connection	Length	Note
558021	3-pin BH, straight	Flying leads	6 ft (1.83 m)	–
558022	3-pin BH, straight		12 ft (3.66 m)	–
558968	4-pin CH, straight		12 ft (3.66 m)	NPN LED, 10 to 30 VDC only
558025	4-pin CH, straight		12 ft (3.66 m)	PNP LED, 10 to 30 VDC only
558024	5-pin BH, straight		12 ft (3.66 m)	–

### Proximity Switch Thread Adapters

	MSP to MX/MXP	MXP to MGO	MSP to MGO
Threads, female by male	7/16-20 f x 3/4-16 m	3/4-16 f x 1 3/8-16 m	7/16-20 f x 1 3/8-16 m
Adapter (bare)	561028	560583	561140
O-ring (one required)	556572	555694	555694

## Air Over Oil Manifolds For MSP Valves

A Graco Exclusive Design! The Air Oil solution that detects air line or oil line faults in your system. Series progressive monitoring ensures your critical bearings are lubricated properly.

### Convenient Manifold Design

Mounts directly to the face of standard MSP series progressive divider valve assembly.

### Check Valve Design

Prevents oil from being forced into the air system if lube lines get crushed or bearings get blocked.

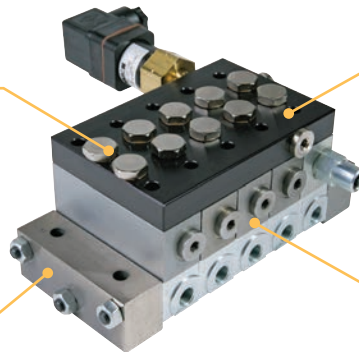

24B240

*Shown installed on MSP divider valve assembly*

### Air Combines With The Oil

After the fluid outlet check, preventing air from backing up into your source oil system.

### Complete Kits

Include manifold, air sensor and check valves for easy installation.

### Typical Applications

- Steel mills, pulp and paper processing, high temperature and dirty environments

### Typical Fluids

- Oil

### Technical Specifications

Material	Aluminum
Minimum Air Pressure	45 psi (3.1 bar)
Maximum Air Pressure	250 psi (17 bar)
Output	3, 4, 5 or 6 Section Divider Valve Assemblies
Instruction Manual	313848

## Ordering Information

### AO Series Manifolds

Part Number	Description
24B237	Air/oil manifold assembly, 3-section
24B239	Air/oil manifold assembly, 4-section
24B240	Air/oil manifold assembly, 5-section
24B241	Air/oil manifold assembly, 6-section
24J814	Air/oil manifold assembly, 3-section without air sensor
24J815	Air/oil manifold assembly, 4-section without air sensor
24J816	Air/oil manifold assembly, 5-section without air sensor
24J817	Air/oil manifold assembly, 6-section without air sensor

### Accessories

Part Number	Description
562994	Air/Oil Spray Nozzle, 3/16 in OD tube inlet x 1/8 in NPT male outlet – 0.6 scfm (17 sclm) air volume per nozzle
16A171	3/16 in OD Nylon tubing, 100 ft (30 m), 2-tube, black/orange
556644	1/8 in NPT x 3/16 in OD compression fittings – for MSP valve outlet ports
105474	Air Solenoid, 24VDC/120VAC
234412	Air Filter, 1/4 in NPT inlet/outlet

# ACCESSORIES

---

	Page
Lubricant Spray . . . . .	165
Zone Valves . . . . .	166
Reset Indicators . . . . .	167
Automatic Relief Indicator . . . . .	168
Rupture Indicator . . . . .	169
Rupture to Atmosphere Indicator . . . . .	170
Magnetic Visual Indicator . . . . .	171
Broken Line Indicator . . . . .	172
Filters . . . . .	173-174
Brushes . . . . .	174
Installation Accessories	
Straight and Angle Swivels . . . . .	175-176
Steel Fittings . . . . .	177-182
Steel Swivel Adapters . . . . .	183-184
Steel JIC Fittings . . . . .	185-190
Stainless Steel Fittings . . . . .	191-192
Stainless Steel Swivel Adapters . . . . .	193
Stainless Steel JIC Fittings . . . . .	194-196
Check Valves . . . . .	197-202
Pressure Sensors . . . . .	203
Pressure Gauges . . . . .	204
Other Fittings and Accessories . . . . .	205-206
Hoses, Tubing and Fittings . . . . .	207-219

## Air-Lube Spra-Control Valve

The Graco Trabon Spra-Control Valve automatically allows pressurized air to enter the air-lube mixing nozzle when supplied with lubricant under pressure. The Spra-Control Valve also shuts off the pressurized air supply to the nozzle when the lubricant pressure ceases. Lubricant, oil or grease can be supplied directly from the pump, as in the case of a single isolated spray; it can also be supplied from injectors or divider valves which feed several Spra-Control Valves. In some cases where multipurpose lubricant is used, bearing taps and gear sprays may be served by the same pump and manifold system. Air-lube nozzles providing round or flat cone spray patterns are of the non-clogging external mix type.

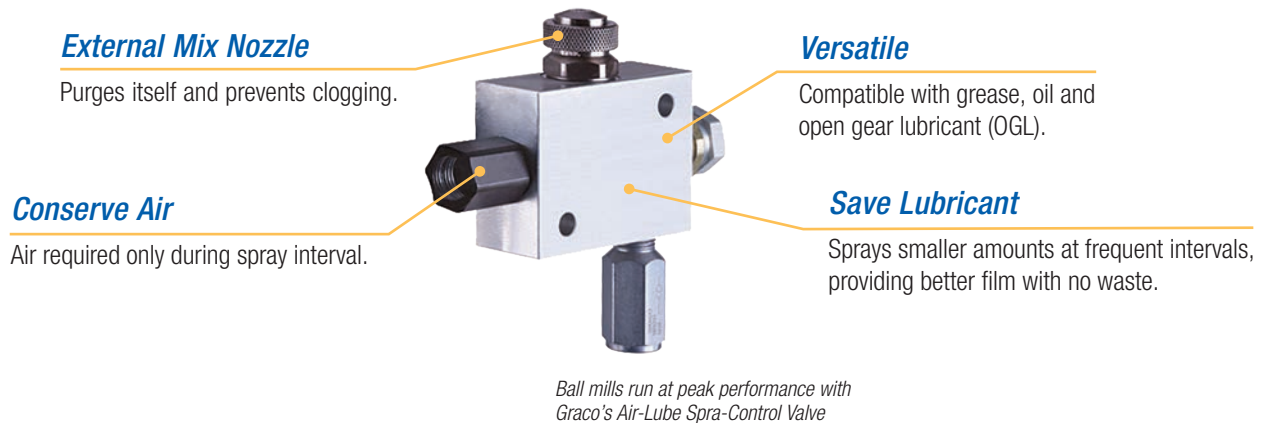

### Typical Applications

- Ball mills, rolling dryers, chains, conveyors, open gears
- Not to be used with G3, G-Mini or other low flow pumps

### Typical Fluids

- Oil – minimum of 100 SUS at 100°F
- Grease – NLGI #1 at any temperature, NLGI #2 at 32°F or above

### Technical Specifications

Material	Aluminum
Minimum Air Pressure	20 psi (1.4 bar)
Maximum Air Pressure	150 psi (10.3 bar)
Spray Pattern	4 in or 8 in (10.2 cm or 20.3 cm)
Instruction Manual	3A3114

## Ordering Information

### Spra-Control Valves

Part Number	Description
563275	Air-lube control valve and nozzle assembly – 4 in spray diameter, round pattern
563276	Air-lube control valve and nozzle assembly – 8 in spray diameter, flat/oblong pattern

### SG-2 Spray System Components

Part Number	Description
563129	Air Oil Mixing Tee
562994	Spray Nozzle for air/oil systems – use with mixing tee 563129 or any MSP air oil manifold
555727	Spare Compression Ferrule
555728	Spare Compression Nut

## Zone Valves

### Features and Benefits

- Designed to custom fit lubrication systems and control when sections or zones of the system will receive lubricant
- Available normally closed and normally open
- 24 VDC models meet typical application requirements

### Ordering Information

Zone Valves	
24P976	Two-way valve, 24 VDC, normally open, Deutsch cable, 3,500 psi (241 bar)
24T296	Two-way valve, 24 VDC, normally closed, Deutsch cable, 3,500 psi (241 bar)



24P976

## Features and Benefits

- Provides quick troubleshooting tool with visual indication
- No tools for reset or parts to replace after indication
- Easy information on blocked lines, high system pressure or blocked bearings

## Technical Specifications

Reset w/Memory psi (bar)	250 (17)	500 (35)	750 (52)	1,000 (69)	1,500 (103)	2,000 (138)	2,500 (172)
MJ	•	•	•	•	•	•	
MSP	•	•	•	•	•	•	•
MXP	•	•	•	•	•	•	•
MX	•	•	•	•	•	•	•
MGO					•		



563242

Simple point troubleshooting with visual indication

## Ordering Information

Divider Valve Reset Indicator w/Memory for MJ, MSP, MHH and MXP	
563231	250 psi (17 bar)
563232	500 psi (35 bar)
563233	750 psi (52 bar)
563234	1,000 psi (69 bar)
563235	1,500 psi (103 bar)
563236	2,000 psi (138 bar)
563237	2,500 psi (172 bar)
563238	3,500 psi (241 bar)
Divider Valve Reset Indicator w/Memory and O-Ring Seal for MX	
563239	250 psi (17 bar)
563240	500 psi (35 bar)
563241	750 psi (52 bar)
563242	1,000 psi (69 bar)
563243	1,500 psi (103 bar)
563244	2,000 psi (138 bar)
563245	2,500 psi (172 bar)
Divider Valve Reset Indicators w/Memory and O-Ring Seal for MSP, MHH and MXP	
563252	250 psi (17 bar)
563253	500 psi (35 bar)
563254	750 psi (52 bar)
563255	1,000 psi (69 bar)
563256	1,500 psi (103 bar)
563257	2,000 psi (138 bar)
563258	2,500 psi (172 bar)
563261	3,000 psi (207 bar)
563262	5,000 psi (345 bar)
563263	3,500 psi (241 bar)
Divider Valve Reset Indicators w/Memory and O-Ring Seal for MGO	
564200	1,500 psi (103 bar)

# Automatic Relief Indicator

## Features and Benefits

These performance indicators pinpoint lube line blockages but allow the lube system to continue to supply lubrication to points that are not blocked.

- Allows machine to continue to run while non-critical bearings are lubricated
- No time or effort required for reset after blockage is cleared
- Easy information on blocked lines, high system pressure or blocked bearings

## Typical Applications

- Works with MSP, MX, MXP, MJ and MHH divider valves

## Technical Specifications

Auto Relief psi (bar)	750 (52)	1,000 (69)	1,250 (86)	1,500 (103)	2,000 (138)	2,500 (172)	3,000 (207)
MJ	•	•		•	•		
MSP	•	•	•	•	•	•	•
MXP	•	•	•	•	•	•	•
MX		•		•	•	•	•



563159

*Keep your machine running while lubrication gets to critical points*

## Ordering Information

Divider Valve Automatic Relief Indicators for MX	
563156	750 psi (52 bar)
563157	1,000 psi (69 bar)
563158	1,500 psi (103 bar)
563159	2,000 psi (138 bar)
563160	2,500 psi (172 bar)
563161	3,000 psi (207 bar)
Divider Valve Automatic Relief Indicators for MSP, MHH, MXP and MJ	
563162	150 psi (10 bar)
563375	600 psi (41 bar)
563163	750 psi (52 bar)
563164	1,000 psi (69 bar)
563166	1,500 psi (103 bar)
563167	2,000 psi (138 bar)
563168	2,500 psi (172 bar)
563169	3,000 psi (207 bar)
Divider Valve Automatic Relief Indicators with O-Ring Seal for MSP, MHH and MXP	
563170	750 psi (52 bar)
563171	1,000 psi (69 bar)
563172	1,250 psi (86 bar)
563173	1,500 psi (103 bar)
563174	2,000 psi (138 bar)
563175	2,500 psi (172 bar)
563176	3,000 psi (207 bar)

## Features and Benefits

Used on MH divider valve applications where lube system pressures exceed 2,500 psi.

- High pressure from blockage causes a disk to rupture
- Lubricant forces an indicator pin to protrude, indicating the blockage
- High pressure backs up through the system and trips a switch to shut the system off
- When fault is corrected, disk must be replaced and pin reset

## Typical Applications

- Works with MHH divider valves

## Ordering Information

Divider Valve Rupture Indicators w/Memory	
563220	3,700 psi (255 bar)
563228	2,800 psi (193 bar)
564355	4,600 psi (317 bar)
563223	5,500 psi (379 bar)
563225	6,400 psi (441 bar)
563229	2,800 psi (193 bar) with o-ring seal
563221	3,700 psi (255 bar) with o-ring seal
563222	4,600 psi (317 bar) with o-ring seal
563224	5,500 psi (379 bar) with o-ring seal
563226	6,400 psi (441 bar) with o-ring seal
Replacement Rupture Disks	
557422	2,800 psi (193 bar)
557423	3,700 psi (255 bar)
557424	4,600 psi (317 bar)
557425	5,500 psi (379 bar)
557427	6,400 psi (441 bar)
557428	7,300 psi (503 bar)
557429	8,200 psi (565 bar)



563229

*Know quickly when critical bearings aren't getting lubricated*

# Rupture to Atmosphere Indicator

## Features and Benefits

- Used in conjunction with system pressure switch – can warn of a fault while allowing lube system to continue to deliver to critical bearings
- Requires replacement of the rupture disk to restart the lube system
- Easy information on blocked lines, high system pressure or blocked bearings



563191

*Blockages are easy to detect with the simple Rupture to Atmosphere indicator*

Rupture to Atmosphere psi (bar)	1,450 (100)	1,750 (121)	2,050 (141)	2,350 (162)	2,950 (203)	3,250 (224)
MJ		•		•	•	•
MSP		•		•	•	•
MX	•	•	•	•	•	

## Ordering Information

Rupture-to-Atmosphere Indicators for MJ, MSP, MHH and MXP	
564059	1,750 psi (121 bar)
563191	2,350 psi (162 bar)
563192	2,950 psi (203 bar)
563193	3,250 psi (224 bar)
563194	5,000 psi (345 bar)
563218	6,400 psi (441 bar)
563219	7,300 psi (503 bar)
563217	5,500 psi (379 bar)
Rupture-to-Atmosphere Indicators for MX	
563179	1,450 psi (100 bar)
563182	1,750 psi (121 bar)
563183	2,050 psi (141 bar)
563184	2,350 psi (162 bar)
563185	2,950 psi (203 bar)
563186	1,450 psi (100 bar), with spud assembly
563187	1,750 psi (121 bar), with spud assembly
563188	2,350 psi (162 bar), with spud assembly
Replacement Rupture Packs of 6 (11/16 in / 17.5 mm diameter disks)	
563962	1,450 psi (100 bar) – yellow
563963	1,750 psi (121 bar) – red
563964	2,050 psi (141 bar) – orange
563965	2,350 psi (162 bar) – aluminum
563966	2,950 psi (203 bar) – blue
Replacement Rupture Packs of 25 (3/8 in / 9.5 mm diameter disks)	
563954	1,450 psi (100 bar) – yellow
563955	1,750 psi (121 bar) – red
563956	2,050 psi (141 bar) – orange
563957	2,350 psi (162 bar) – aluminum
563958	2,650 psi (183 bar) – pink
563959	2,950 psi (203 bar) – blue
563960	3,250 psi (224 bar) – purple
563961	5,000 psi (345 bar) – brown

## Features and Benefits

Six steel balls in a clear sleeve follow a magnet which moves with the cycling piston, providing a clear visual indication of lube cycles.

## Ordering Information

Divider Valve Cycle Indicators and Switches	
563251	MS/MHH visual cycle indicator assembly – o-ring seal
563260	MX/MXP visual cycle indicator assembly



563251

## Cycle Switch

- Monitors piston movement to ensure completed lubrication cycle – must have cycle indicator pin
- Provides positive feedback based on actual metering piston movement
- Mounts to MJ, MSP, MXP, or MX divider with cycle pin option with simple install
- Able to be set for normally open or normally closed operation

## Technical Specifications

Voltage	Amp Rating
125/250/480 VAC .....	15A
125 VDC .....	1/2A
250 VDC .....	1/4A
24 VDC .....	.6A*

\*non-inductive



563272

*Integrates to controllers, starters or PLCs*

## Ordering Information

Cycle Switches	
563270	MD-2, cycle switch, bracket assembly
563271	MD-3, cycle switch, bracket assembly
564356	MD-4, cycle switch, bracket assembly
563269	MGO cycle switch (SPDT), bracket assembly
557781	Replacement cycle switch for 563269, 563270, 563271, 564356, 563272
564357	MJ/MS/MHH/MXP cycle switch (DPDT) bracket assembly
563272	MJ/MS/MHH/MXP cycle switch (SPDT) bracket assembly
563273	MJ/MS/MHH/MXP cycle switch (SPDT) bracket assembly – moisture resistant
557546	Replacement bracket – 563272, 563273, 564357
260067	1/2 in NPT cord grip for use with switch 557781

# Broken Line Indicators

## Features and Benefits

- Monitors lube line integrity to ensure lubricant is delivered to critical bearings
- Provides a visual or electronic indication
- Works with terminating oil or grease systems as well as recirculating systems

## Technical Specifications

	BLI500	BLI1000	BLI1500
Simulator Pressure	60 psi (4.1 bar)	100 psi (6.9 bar)	150 psi (10.3 bar)
Minimum Pump Pressure	1,000 psi (69.0 bar)	1,500 psi (103.4 bar)	2,500 psi (172.4 bar)
Application	Recirculating Oil	Recirculating Oil or Terminating Oil	Grease



563079

*The only device that provides visual indication that bearing lines are intact*

## Ordering Information

Broken Line Indicators										
System Type	BLI Rating	Simulator Rating	$\Delta P$	Pressure Switch Setting (psi)	Pump Relief Valve (psi)	Blowout Disk (psi)	Minimum Pump Capacity (psi)	BLI Kit Part Number	BLI Part Number	Simulator Part Number
Re-Circulating Oil	500	60	440	400	700	N/A	1,000	563078	563068	563075
Re-Circulating Oil	1,000	100	900	850	1,400	N/A	1,500	563079	563069	563076
Terminating Oil	1,000	100	900	850	N/A	1,450	2,000	563079	563069	563076
Terminating Grease	1,500	150	1,350	1,300	N/A	2,350	2,500	563080	563070	563077

## Ordering Information

All filter ports are female both end (fbe) unless otherwise stated. For more details, search [www.graco.com](http://www.graco.com) for brochure L15200.

MSP Inlet Oil Filters – Typically used as a secondary filter at the inlet of MSP divider valve assemblies.				
Part Number	Type	Max Pressure PSI (bar)	Ports	Micron Rating
563074	MSP zero-leak inlet "last chance" filter/restrictor	3,500 (241)	1/4-18 NPSF f x 1/4-18 NPTF m	90
563073	MSP zero-leak and shunt "last chance" filter		9/16-18 SAE-ORB female x male	
564342	MSP standard and zero-leak inlet filter		1/4-19 BSPP female x male	
563480	ZMSP modular filter block	3,000 (207)	Mounts on base 563479	25

Replacement Elements For Legacy Single and Dual Cartridge Filters – Use to replace string filters and pleated elements in legacy Trabon/Manzel canister filters.			
Part Number	Dimensions	Micron Rating	Where used – legacy filter part number
557803	2-5/8 in (67 mm) OD x 3-5/8 in (92 mm) L	10	183-000-001, 183-000-041, 183-000-141
557804		25	183-000-011, 183-000-051, 183-000-151
557805		50	50 micron alternate for 3-5/8 in elements (above)
557806	2-5/8 in (67 mm) OD x 9-5/8 in (244 mm) L	10	183-000-071, 183-000-111, 183-000-201
557807		25	183-000-081, 183-000-121, 183-000-211
557808		50	50 micron alternate for 9-5/8 in elements (above)
557811		1	1 micron alternate for 9-5/8 in elements (above)

Spin-On Oil Filters – Low pressure, high flow oil filters for applications up to 20 gpm (76 lpm). Typical applications include return lines in recirculating systems and fill lines.					
Part Number	Type	Max Pressure PSI (bar)	Ports	Replacement Element	Micron Rating
563095	Assembly with external 150 PSI (10.3 bar) relief	200 (13.8)	3/4-14 NPT	563093	10
564343	Assembly 563095 with fill stud and mounting bracket				
563096	Assembly with external 150 PSI (10.3 bar) relief				
563099	Assembly with external 150 PSI (10.3 bar) relief	150 (10.3)	3/4-14 BSPP (ISO 1179-1)	563097	25
563100	Assembly with external 150 PSI (10.3 bar) relief		M27x2 (ISO 6149)		

Spare Parts for Spin-On Oil Filters	
Part Number	Type
563162	150 PSI external relief valve, 1/8 NPT
558927	Filter mounting bracket

# Filters and Brushes

## Ordering Information

**In-Line Oil Filter – High-Pressure** – Use with Trabon and G-series pumps in medium duty applications. Miniature Meter-Flo and Modu-Flo oil tanks include a bracket designed to receive these filters. Always mount plug end down, so the contaminants fall out with the element when it's changed. Use bleed ports on top to purge air.

Part Number	Max Pressure PSI (bar)	Ports	Replacement Element	Micron Rating
563511	7,500 (517)	1/4-18 NPTF	563509	10
563512			563510	25
563516		1/4-19 BSPP (ISO 1179)	563509	10
563515			563510	25

**In-Line Grease/Heavy Oil Strainer – High-Pressure** – Use with Trabon and G-series pumps in medium duty applications. Install on reservoir fill line or near pump outlet to protect system from contaminants. Always mount plug end down, so the contaminants fall out with the element when it's changed. Use bleed ports on top to purge air.

Part Number	Type	Max Pressure PSI (bar)	Ports	Replacement Element	Micron Rating (Mesh Rating)
563508	Heavy oil strainer	7,500 (517)	1/4-18 NPTF	557701	44 (325)
563507	Grease strainer		1/4-18 NPTF	557700	149 (100)
564406			1/4-19 BSPP (ISO 1179)		

**Fill Point Strainers with Removable Element** – Installs in fill port on reservoirs with 1/4 in NPT thread.

Part Number	Type	Max Pressure PSI (bar)	Ports	Replacement Element	Micron Rating (Mesh Rating)
563103	Oil	3,000 (207)	1/4-18 NPSF f x 1/4-18 NPTF m	557154	44 (325)
563102	Grease			557153	149 (100)

**Barrel Pump Fill Line Filter** – Small inline filter for use as a fill filter for barrel pump modules including Fire-Ball and Dyna-Star families.

Part Number	Type	Max Pressure PSI (bar)	Ports	Replacement Element	Micron Rating
77X523	Inline fill line filter	5,000 (344)	3/8-18 NPTF female inlet x male outlet	77X541	400

**“Red Alert” Grease Filter** – Ideal for use as a fill line filter for barrel pump modules including Fire-Ball and Dyna-Star families. The indicator provides gradual warning of a dirty element.

Part Number	Type	Max Pressure PSI (bar)	Ports	Replacement Element	Micron Rating
17L366	36 in <sup>2</sup> steel mesh filter, 2 gpm (7.57 lpm) flow capacity	3,000 (207)	3/4-14 NPT	129031	380

### Oil Brushes

Part Number	Material	Dimensions	Maximum Temperature	Thread
124089	Horsehair	3/4 in (20 mm) diameter	176°F (80°C)	1/4 in-19 BSPP female
124090		1.2 in (30 mm) x 1.6 in (40 mm)		



124089



124090

## Go for a Spin

The Trabon Straight and Angle Swivels are available in standard ball bearing or compact types. Primarily designed for medium to high pressure service in centralized oil and grease systems, these swivels provide a simple and inexpensive means of making line connections between either stationary, or oscillating surfaces.

### Ball Bearing Swivels

Turn freely at high pressure without binding and should always be used if space permits. Stems and nuts are hardened to minimize wear.

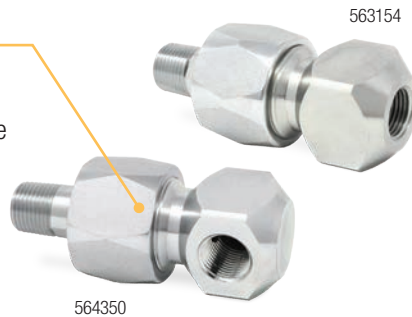

### Typical Fluids

- Oil or Grease up to NLGI #2

### Technical Specifications

Material	Carbon Steel
Packing	Buna
Maximum RPM	1800

### Ordering Information

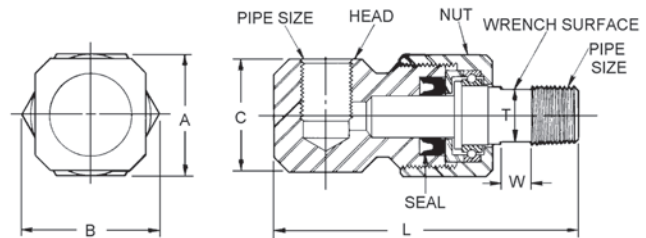

### Straight and Angle Ball Bearing Swivels

Pipe Thread	Part Number		Maximum Pressure PSI (Bar)	Dimension in Inches (mm)						
	90° Angle	Straight		Ball Diameter	Hex Nut (A)	Hex Nut (B)	Square Head (C)	Length (L)	Flat (T)	Flat (W)
1/8 in-27	563212	563213	1,500 (103.5)	0.09 (2.3) qty 14	0.875 (22.2)	1.01 (25.7)	0.75 (19.1)	2.28 (57.9)	0.31 (7.9)	0.25 (6.4)
1/4 in-18	563214	563215	1,500 (103.5)	0.09 (2.3) qty 18	1.00 (25.4)	1.15 (29.2)	0.875 (22.2)	2.75 (69.9)	0.44 (11.1)	0.31 (7.9)
3/8 in-18	563153	564349	3,000 (207)	Ball Bearing	1.375 (34.9)	1.62 (41.1)	1.125 (28.6)	3.93 (99.8)	0.56 (14.3)	0.37 (9.5)
1/2 in-14	564350	563154	3,000 (207)	Ball Bearing	1.75 (44.5)	2.03 (51.6)	1.50 (38.1)	4.50 (114.3)	0.75 (19.0)	0.44 (11.1)
3/4 in-14	—	564351	3,000 (207)	Ball Bearing	1.875 (47.6)	2.18 (55.4)	1.75 (44.5)	5.37 (136.4)	0.94 (23.8)	0.50 (12.7)

# Installation Accessories – Straight and Angle Swivels

## Compact Swivels

Manufactured without ball bearings and are not intended for rotary, or oscillating movement. Should be used only for positioning a connection, or where occasional movement is required.

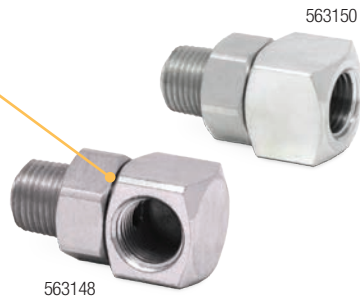

### Typical Fluids

- Oil or Grease up to NLGI #2

### Technical Specifications

Material	Plated or 303 Stainless
Packing	Buna

## Ordering Information

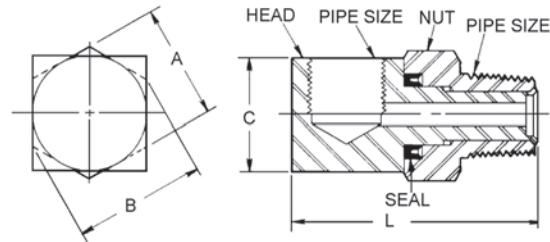

## Straight and Angle Compact Swivels

Pipe Thread	Part Number		Maximum Pressure PSI (Bar)	Material of Construction	Dimension in Inches (mm)			
	90° Angle	Straight			Hex Nut (A)	Hex Nut (B)	Square Head (C)	Length (L)
1/8 in-27	563148	563150	500 (34.5)	Carbon Steel	0.563 (14.3)	0.65 (16.5)	0.563 (14.3)	1.12 (28.4)
1/8 in-27	563149	–	500 (34.5)	303 Stainless	0.563 (14.3)	0.65 (16.5)	0.563 (14.3)	1.12 (28.4)
1/4 in-18	563146	563147	500 (34.5)	Carbon Steel	0.75 (19.1)	1.06 (26.9)	0.75 (19.1)	1.62 (41.1)

## Ordering Information

### Pipe Thread Steel Fittings

#### 45° Street Elbows

Male Thread	Female Thread	Maximum Pressure PSI (Bar)	Part Number
1/4 in-18 NPT	1/4 in-18 NPT	3,500 (241)	119789
1/4 in-18 NPT	1/4 in-18 NPT	5,000 (345)	121283
3/8 in-18 NPT	3/8 in-18 NPT	4,000 (276)	116756
1/2 in-14 NPT	1/2 in-14 NPT	4,000 (276)	116755
3/4 in-14 NPT	3/4 in-14 NPT	5,000 (345)	113445
1 in-11.5 NPT	1 in-11.5 NPT	4,200 (290)	123888

#### 45° Street Elbows – Zero Radius

Male Thread	Female Thread	Maximum Pressure PSI (Bar)	Part Number
1/4 in-28 SAE tapered	1/8 in-27 NPTF	–	557954
1/8 in-27 NPT	1/8 in-27 NPT	–	557395
1/4 in-18 PTF SAE Short	1/4 in-18 PTF SAE extra short	–	560532



#### 90° Street Elbows

Male Thread	Female Thread	Maximum Pressure PSI (Bar)	Part Number
1/8 in-27 NPT	1/8 in-27 NPT	5,000 (345)	112307
1/4 in-18 NPT	1/4 in-18 NPT	4,000 (276)	118137
3/8 in-18 NPT	3/8 in-18 NPT	4,500 (310)	111856
3/4 in-14 NPT	3/4 in-14 NPT	3,000 (207)	122327
1 in-11.5 NPT	1 in-11.5 NPT	4,200 (290)	123889
1.25 in-11.5 NPT	1.25 in-11.5 NPT	6,000 (414)	C38324

#### 90° Street Elbows – Zero Radius

Male Thread	Female Thread	Maximum Pressure PSI (Bar)	Part Number
1/4 in-28 SAE tapered	1/8 in-27 NPTF	–	15K784
1/8 in-27 PTF SAE short*	1/8 in-27 PTF SAE short*	–	15K783
1/8 in-27 NPT	1/8 in-27 NPT	3,600 (248)	100839
1/8 in-27 NPTF	1/4 in-18 NPSF	–	560530
1/8 in-28 BSPT	1/8 in-27 PTF SAE short*	–	17K061
1/4 in-18 NPTF	1/4 in-18 NPSF	–	15M045
1/4 in-18 NPTF	1/8 in-27 PTF SAE short*	–	560533
1/4 in-18 NPT	1/4 in-18 NPT	7,500 (517)	100840
3/8 in-18 NPT	1/4 in-18 NPT	7,250 (500)	164259
3/8 in-18 NPT	3/8 in-18 NPT	7,250 (500)	155699
1/2 in-14 NPT	3/8 in-18 NPT	7,250 (500)	166999
1/2 in-14 NPT	1/2 in-14 NPT	7,400 (510)	158683
1/2 in-14 NPT	1/2 in-14 NPT	3,000 (207)	115764
3/4 in-14 NPT	3/4 in-14 NPT	7,250 (500)	166590



\*1/8 in-27 PTF SAE short thread is common on grease nipples (Zerks).

# Installation Accessories – Steel Fittings

## Ordering Information

### Pipe Thread Steel Fittings

#### 90° Street Elbows Extension Fittings – Zero Radius

Male Thread	Female Thread	Total Length	Part Number
1/8 in-27 NPT	1/8 in-27 NPT	1.4 in (35.6 mm)	191892
1/8 in-27 NPT	1/8 in-27 NPT	2.0 in (50.8 mm)	160701

#### Hex Nipples – Standard and Reducing

Male Thread (A)	Male Thread (B)	Maximum Pressure PSI (Bar)	Part Number
1/8 in-27 NPT	1/8 in-27 NPT	6,000 (414)	C20477
1/4 in-18 NPT	1/8 in-27 NPT	4,000 (276)	16Y235
1/4 in-18 NPT	1/8 in-27 NPT	6,000 (414)	16D939
1/4 in-18 NPT	1/8 in-27 NPT	7,500 (517)	151519
1/4 in-18 NPTF	1/8 in-27 NPTF	–	556408
1/4 in-18 NPT	1/4 in-18 NPT	7,500 (517)	156971
1/4 in-18 NPTF	1/4 in-18 NPTF	–	555453
3/8 in-18 NPT	1/8 in-27 NPT	–	156296
3/8 in-18 NPT	1/4 in-18 NPT	4,000 (276)	123379
3/8 in-18 NPT	1/4 in-18 NPT	6,000 (414)	157350
3/8 in-18 NPT	1/4 in-18 NPT	10,000 (689)	165198
3/8 in-18 NPT	3/8 in-18 NPT	7,250 (500)	156849
1/2 in-14 NPT	1/4 in-18 NPT	7,400 (510)	162449
1/2 in-14 NPT	3/8 in-18 NPT	7,400 (510)	159239
1/2 in-14 NPT	3/8 in-18 NPT	7,400 (510)	16F255
1/2 in-14 NPT	1/2 in-14 NPT	7,400 (510)	158491
1/2 in-14 NPT	1/2 in-14 NPT	6,000 (414)	C20485
3/4 in-14 NPT	3/8 in-18 NPT	4,000 (276)	194048
3/4 in-14 NPT	1/2 in-14 NPT	6,000 (414)	157191
3/4 in-14 NPTF	1/2 in-14 NPTF	6,000 (414)	C20461
3/4 in-14 NPTF	3/4 in-14 NPTF	5,500 (379)	C20487
3/4 in-14 NPT	3/4 in-14 NPT	7,250 (500)	175013
3/4 in-14 NPT	3/4 in-14 NPT	7,250 (500)	160032
1 in-11.5 NPT	3/4 in-14 NPT	3,000 (207)	158555
1 in-11.5 NPT	1 in-11.5 NPT	3,000 (207)	C20489
1 in-11.5 NPT	1 in-11.5 NPT	4,500 (310)	17G388
1 in-11.5 NPT	1 in-11.5 NPT	6,000 (414)	131526
1.25 in-11.5 NPTF	3/4 in-14 NPT	3,000 (207)	124508
1.25 in-11.5 NPTF	1 in-11.5 NPTF	5,000 (345)	C20465
1.25 in-11.5 NPTF	1.25 in-11.5 NPTF	3,000 (207)	C20490
1.5 in-11.5 NPT	1 in-11.5 NPT	3,000 (207)	17G711
9/16 in-18 SAE-ORB (Buna-N)	9/16 in-18 SAE-ORB (Buna-N)	6,000 (414)	131169



555453



156296



156849

## Ordering Information

### Pipe Thread Steel Fittings

#### Hex Couplings – Standard and Reducing

Female Thread (A)	Female Threads (B)	Maximum Pressure PSI (Bar)	Part Number
1/8 in-27 NPSF	1/8 in-27 NPSF	–	560528
1/8 in-27 NPT	1/8 in-27 NPT	–	100451
1/4 in-18 NPT	1/4 in-18 NPT	7,250 (500)	113093
3/8 in-18 NPT	1/4 in-18 NPT	6,000 (414)	132139
3/8 in-18 NPT	3/8 in-18 NPT	7,250 (500)	162024
1/2 in-14 NPT	1/2 in-14 NPT	7,250 (500)	158581
3/4 in-14 NPT	3/4 in-14 NPT	4,000 (276)	16P292
1 in-11.5 NPT	1 in-11.5 NPT	3,000 (207)	100474
1.5 in-11.5 NPT	1 in-11.5 NPT	3,000 (207)	116650



560528

#### Reducing Bushings

Male Thread	Female Thread	Maximum Pressure PSI (Bar)	Part Number
1/4 in-18 NPTF	1/8 in-27 NPTF	–	556402
1/4 in-18 NPT	1/8 in-27 NPT	–	100030
3/8 in-18 NPT	1/4 in-18 NPT	7,250 (500)	159841
3/8 in-18 NPT	1/4 in-18 NPT	6,000 (414)	118758
3/8 in-18 NPT	1/4 in-18 NPT	6,000 (414)	129535
3/8 in-18 NPTF	1/8 in-27 NPTF	–	556403
3/8 in-18 NPTF	1/4 in-18 NPTF	–	556404
1/2 in-14 NPTF	1/8 in-27 NPTF	–	556405
1/2 in-14 NPTF	3/8 in-18 NPTF	–	556406
1/2 in-14 NPT	1/4 in-18 NPT	7,250 (500)	100206
1/2 in-14 NPT	3/8 in-18 NPT	3,000 (207)	18B302
1/2 in-14 NPT	3/8 in-18 NPT	4,000 (276)	158212
1/2 in-14 NPT	3/8 in-18 NPT	6,000 (414)	100081
3/4 in-14 NPT	1/4 in-18 NPT	5,000 (345)	100615
3/4 in-14 NPTF	1/4 in-18 NPTF	–	558794
3/4 in-14 NPT	1/4 in-18 NPT	7,250 (500)	C19681
3/4 in-14 NPT	3/8 in-18 NPT	5,000 (345)	100505
3/4 in-14 NPT	1/2 in-14 NPT	5,000 (345)	100896
3/4 in-14 NPT	1/2 in-14 NPT	5,000 (345)	C19685
1 in-11.5 NPT	1/2 in-14 NPT	4,500 (310)	100380
1 in-11.5 NPT	3/4 in-14 NPT	6,000 (414)	158586
1.25 in-11.5 NPT	1/2 in-14 NPT	6,000 (414)	C19660



556403



158586

# Installation Accessories – Steel Fittings

## Ordering Information

### Pipe Thread Steel Fittings

#### Expanding Bushings

Male Thread	Female Thread	Maximum Pressure PSI (Bar)	Part Number
1/4 in-28 SAE tapered	1/8 in-27 NPT	–	557955
1/8 in-27 NPT	1/4 in-18 NPT	–	556416
1/8 in-27 NPT	1/4 in-18 NPT	–	159840
1/8 in-27 NPT	3/8 in-18 NPT	–	156580
1/4 in-18 NPT	3/8 in-18 NPT	8,000 (552)	150287
1/4 in-18 NPT	1/2 in-14 NPT	–	159842
3/8 in-18 NPT	1/2 in-14 NPT	4,000 (276)	156022
1/2 in-14 NPT	3/4 in-14 NPT	7,250 (500)	16T315



557955

#### Extension Fittings – Straight

Male Thread	Female Thread	Total Length	Part Number
1/4 in-18 PTF SAE short	1/8 in-27 NPTF	0.75 in (19.1 mm)	557392
1/8 in-27 NPT	1/8 in-27 NPT	1.0 in (25.4 mm)	150171
1/8 in-27 NPTF	1/8 in-27 NPSF	1.25 in (31.75 mm)	557393
1/8 in-27 NPT	1/8 in-27 NPSF	2.5 in (63.5 mm)	563178
3/8 in-18 NPT	1/4 in-18 NPT	2.75 in (69.9 mm)	162718
3/8 in-18 NPT	3/8 in-18 NPT	1.5 in (38.1 mm)	150286



557392

#### Adapter Fittings

Male Thread	Female Thread	Shape	Part Number
1/8 in-28 BSPT	1/8 in-27 PTF SAE short	90° Elbow – Zero Radius	17K061
1/8 in-28 BSPT	1/8 in-27 NPTF	Straight – 1.08 in (22.4 mm) L	17G422
1/8 in-28 BSPT	1/8 in-27 NPSF	Straight – 1.25 in (31.8 mm) L	17K062
M6 x0.75	1/8 in-27 NPTF	Straight – 1.04 in (26.5 mm) L	131430
M10 x1	1/8 in-27 NPTF	Straight – 1.25 in (31.8 mm) L	131466
9/16 in-18 SAE-ORB (Buna-N)	1/4 in-18 NPT	Straight Adapter	129764
9/16 in-18 SAE-ORB (Buna-N)	3/8 in-18 NPT	90° Elbow Adapter	127104



17K061



17G422

#### Tee Fittings – Female

Thread	Maximum Pressure PSI (Bar)	Part Number
1/8 in-27 NPT	3,000 (207)	C19466
1/4 in-18 NPT	5,000 (345)	104984
3/8 in-18 NPT	4,500 (310)	100483
3/4 in-14 NPT	6,000 (414)	132019
1-1/4 in NPT	6,000 (414)	C19491

#### Tee Fittings – Male

Thread	Maximum Pressure PSI (Bar)	Part Number
1/4 in-18 NPT	3,900 (269)	113548
3/8 in-18 NPT	4,000 (276)	113786

## Ordering Information

### Pipe Thread Steel Fittings

#### Tee Fittings – Male Branch

Thread	Maximum Pressure PSI (Bar)	Part Number
1/8 in-27 NPT zero radius	6,000 (414)	164815
1/8 in-27 NPTF	5,000 (345)	558795
1/4 in-18 NPTF	5,000 (345)	556407
3/8 in-18 NPTF	4,500 (310)	128567
1/2 in-14 NPT	3,500 (241)	125644
3/4 in-14 NPT	3,000 (207)	125548



164815



556407

#### Tee Fittings – Male Run (Street Tees)

Thread	Maximum Pressure PSI (Bar)	Part Number
1/8 in-27 NPTF	5,000 (345)	556419
1/4 in-18 NPTF	6,000 (414)	556420
3/8 in-18 NPTF	4,500 (310)	128568
1/2 in-14 NPTF	3,000 (207)	107128
3/4 in-14 NPT	3,000 (207)	16F259



556419

#### Cross Fittings – FFFF Porting

Thread	Maximum Pressure PSI (Bar)	Part Number
1/4 in-18 NPTF	5,000 (345)	17T246
3/8 in-18 NPTF	4,000 (276)	512420
3/4 in-14 NPT	3,000 (207)	U70015
1 in-11.5 NPT	6,000 (414)	121163

#### Cross Fittings – FFFM Porting

Thread	Maximum Pressure PSI (Bar)	Part Number
1/4 in-18 NPTF	5,000 (345)	133643
3/8 in-18 NPTF	4,500 (310)	133644



133643

#### Anchor Fittings

Thread	Shape	Part Number
1/8 in-27 NPSF	Cross	560543
1/4 in-18 NPSF	Cross	560542
1/8 in-27 NPSF	Straight	560540
1/4 in-18 NPSF	Straight	560541
1/2 in-14 NPSF	Straight	558910
1/4 in-18 NPSF	Straight – Double	561430



560543

# Installation Accessories – Steel Fittings

## Ordering Information

### Pipe Thread Steel Fittings

#### Plugs

Thread	Head Shape	Maximum Pressure PSI (Bar)	Part Number
1/8 in-27 NPT	Hex	–	556410
1/8 in-27 NPTF	None (Socket)	–	557349
1/8 in-28 BSPP (Buna-N)	Socket	5,801 (400)	558799
1/4 in-18 NPT	Hex	–	555808
1/4 in-18 NPT	Square	–	111697
1/4 in-18 NPTF	None (Socket)	–	557391
1/4 in-18 NPTF	Square	6,000 (414)	100509
1/4 in-18 PTF SAE short	None (Socket)	7,250 (500)	100721
1/4 in-19 BSPP (Buna-N)	Socket	5,801 (400)	556427
3/8 in-18 NPT	Hex	–	556411
3/8 in-18 NPT	None (Socket)	5,000 (345)	127099
3/8 in-18 NPTF	Square	–	100040
3/8 in-18 NPTF	None (Socket)	7,250 (500)	101754
7/16-20 SAE-ORB (Fluoroelastomer)	Socket	7,500 (517)	567251
1/2 in-14 NPTF	Square	6,000 (414)	100737
1/2 in-14 NPTF	Hex	3,000 (207)	125222
1/2 in-14 PTF SAE short	None (Socket)	7,250 (500)	100361
3/4 in-14 NPT	Square	3,000 (207)	104663
9/16-18 SAE-ORB (Buna-N)	Socket	6,000 (414)	129752
9/16-18 SAE-ORB (Fluoroelastomer)	Socket	5,000 (345)	15H304
3/4-16 SAE-ORB (Fluoroelastomer)	Socket	5,000 (345)	295607
7/8-14 SAE-ORB (Fluoroelastomer)	Socket	–	556424



## Ordering Information

### Swivel Adapters

- Female NPSM swivels allow for easy clocking of the fitting.
- Not a “live” swivel; position is stationary after tightened.

### Straight Swivel Adapters, mbf

Rigid Thread (Male)	Swivel Thread (Female)	Maximum Pressure PSI (Bar)	Part Number
1/8 in	1/4 in	10,000 (689)	208434
1/4 in	1/8 in	5,000 (345)	125783
1/4 in	1/4 in	10,000 (689)	156823
1/4 in	3/8 in	7,500 (517)	157705
3/8 in	3/8 in	7,500 (517)	155665
3/8 in	1/2 in	7,500 (517)	162505
1/2 in	3/8 in	7,500 (517)	158256
1/2 in	1/2 in	7,250 (500)	156684
1/2 in	3/4 in	4,000 (276)	113344
3/4 in	3/4 in	6,000 (414)	157785
1 in	3/4 in	4,500 (310)	202965
1 in	1 in	2,000 (138)	160022
1 in	1 in	3,000 (207)	116648
1 in	1 1/4 in	3,000 (207)	116745



156823

### Straight Swivel Adapters, fbe

Rigid End (Female)	Swivel Thread (Female)	Maximum Pressure PSI (Bar)	Part Number
1/4 in	1/4 in	10,000 (689)	155570
3/8 in	1/4 in	7,500 (517)	159153
3/8 in	3/8 in	7,400 (510)	156173
1/2 in	1/4 in	6,000 (414)	155653
1/2 in	3/8 in	3,500 (241)	161077
1/2 in	1/2 in	7,250 (500)	155865
3/4 in	3/4 in	5,000 (345)	156172
1 in	1 in	2,000 (138)	158383

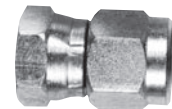

155570

### 90° Elbow Swivel Adapters, mbf

Rigid Thread (Male)	Swivel Thread (Female)	Maximum Pressure PSI (Bar)	Part Number
1/4 in	1/4 in	5,000 (345)	155541
3/8 in	1/4 in	7,000 (483)	155495
3/8 in	3/8 in	5,000 (345)	155494
3/8 in	1/2 in	3,500 (241)	217430
1/2 in	3/8 in	4,000 (276)	161037
1/2 in	1/2 in	5,000 (345)	155470
3/4 in	3/4 in	2,250 (155)	160327



155494

# Installation Accessories – Steel Swivel Adapters

## Ordering Information

### Swivel Adapters

- Female NPSM swivels allow for easy clocking of the fitting.
- Not a “live” swivel; position is stationary after tightened.

### 90° Elbow Swivel Adapters, fbe

Rigid End (Female)	Swivel Thread (Female)	Maximum Pressure PSI (Bar)	Part Number
1/8 in	1/8 in	6,000 (414)	C19005
1/4 in	1/4 in	5,000 (345)	157676
3/8 in	3/8 in	4,000 (276)	155677
3/8 in	1/2 in	3,500 (241)	159801
1/2 in	1/2 in	3,500 (241)	157416
3/4 in	3/4 in	2,250 (155)	156589



155677

### 45° Elbow Swivel Adapters, mbf

Rigid Thread (Male)	Swivel Thread (Female)	Maximum Pressure PSI (Bar)	Part Number
1/4 in	1/4 in	5,000 (345)	114030
3/8 in	3/8 in	4,000 (276)	161889
1/2 in	1/2 in	3,500 (241)	222297
3/4 in	3/4 in	2,200 (152)	105281



161889

### Female Tee: Rigid Branch, Swivel Runs

Rigid Branch (Female)	Swivel Runs (Female)	Maximum Pressure PSI (Bar)	Part Number
1/4 in	1/4 in	5,000 (345)	119783
1/4 in	3/8 in	4,000 (276)	127518

## Ordering Information

### JIC Fittings – Carbon Steel

#### JIC Male Straight Nipples

Male Thread (A)	Male Thread (B)	Maximum Pressure PSI (Bar)	Part Number
JIC-4	JIC-4	7,500 (517)	123251
JIC-6	JIC-6	6,000 (414)	125778
JIC-6	JIC-8	4,500 (310)	123684
JIC-6	JIC-10	3,500 (241)	123683
JIC-8	JIC-8	5,000 (345)	124451
JIC-10	JIC-10	5,000 (345)	130993
JIC-10	JIC-12	5,000 (345)	130996

#### JIC Male Straight Adapters

Male Thread (A)	Male Thread (B)	Maximum Pressure PSI (Bar)	Part Number
JIC-3	1/8 in-27 NPT	6,000 (414)	124403
JIC-4	1/8 in-27 NPT	6,000 (414)	555749
JIC-4	1/4 in-18 NPT	6,000 (414)	556762
JIC-5	1/8 in-27 NPTF	5,000 (345)	125572
JIC-5	1/4 in-18 NPTF	5,000 (345)	117455
JIC-5	1/4 in-18 NPT	5,000 (345)	119998
JIC-5	3/8 in-18 NPT	5,000 (345)	122406
JIC-5	1/2 in-20 SAE-ORB	6,000 (414)	127130
JIC-6	1/4 in-18 NPTF	4,500 (310)	101909
JIC-6	1/4 in-18 NPT	6,000 (414)	122722
JIC-6	1/4 in-18 NPT	5,000 (345)	116704
JIC-6	3/8 in-18 NPT	5,000 (345)	114337
JIC-6	3/8 in-18 NPT	5,000 (345)	117832
JIC-6	1/2 in-14 NPT	6,000 (414)	16V432
JIC-6	7/16 in-20 SAE-ORB (Fluoroelastomer)	6,000 (414)	122720
JIC-6	9/16 in-18 SAE-ORB (Buna-N)	6,000 (414)	129763
JIC-6	9/16 in-18 SAE-ORB (Fluoroelastomer)	6,000 (414)	127131
JIC-8	1/4 in-18 NPT	5,000 (345)	121310
JIC-8	1/4 in-18 NPT	4,500 (310)	122992
JIC-8	1/4 in-18 NPT	5,000 (345)	116703
JIC-8	3/8 in-18 NPT	4,500 (310)	117833
JIC-8	3/8 in-18 NPT	5,000 (345)	121311
JIC-8	1/2 in-14 NPT	5,000 (345)	121319
JIC-8	1/2 in-14 NPT	6,000 (414)	124287
JIC-8	3/4 in-14 NPT	5,500 (379)	124286
JIC-8	3/4 in-14 NPT	5,000 (345)	124913
JIC-8 (Long Leg)	3/4 in-16 SAE-ORB (Buna-N)	6,000 (414)	122970
JIC-8	9/16 in-18 SAE-ORB (Buna-N)	4,500 (310)	120185
JIC-10	1/4 in-18 NPT	5,000 (345)	116702
JIC-10	3/8 in-18 NPT	5,000 (345)	116765



555749



117832



129763

# Installation Accessories – Steel JIC Fittings

## Ordering Information

### JIC Fittings – Carbon Steel

#### JIC Male Straight Adapters (Cont.)

Male Thread (A)	Male Thread (B)	Maximum Pressure PSI (Bar)	Part Number
JIC-10	1/2 in-14 NPT	5,000 (345)	15Y925
JIC-10	1/2 in-14 NPT	4,000 (276)	C20768
JIC-10	3/4 in-14 NPT	5,000 (345)	15Y934
JIC-10	1 in-11.5 NPT	4,500 (310)	130992
JIC-12	3/8 in-18 NPT	4,500 (310)	116766
JIC-12	1/2 in-14 NPT	5,000 (345)	132440
JIC-12	3/4 in-14 NPT	5,000 (345)	124406
JIC-12	3/4 in-14 NPT	3,500 (241)	C20708
JIC-12	1 in-11.5 NPT	5,000 (345)	123135
JIC-16	1/2 in-14 NPT	4,500 (310)	124288
JIC-16	1/2 in-14 NPT	4,500 (310)	125662
JIC-16	3/4 in-14 NPT	4,500 (310)	125661
JIC-16	1 in-11.5 NPT	5,000 (345)	123854
JIC-16	1.25 in-11.5 NPT	3,000 (207)	124968
JIC-20	1 in-11.5 NPT	3,500 (241)	15D936
JIC-20	1.25 in-11.5 NPT	3,000 (207)	125660

#### JIC Male x NPT Female Straight Adapter Fittings

Male Thread	Female Thread	Maximum Pressure PSI (Bar)	Part Number
JIC-4	1/4 in-18 NPT	6,000 (414)	127093
JIC-5	1/8 in-27 NPT	5,500 (379)	16U878
JIC-6	1/8 in-27 NPT	5,500 (379)	16U879
JIC-8	1/4 in-18 NPT	6,000 (414)	125403
JIC-8	3/4 in-18 NPTF	5,000 (345)	124903
JIC-10	1/2 in NPTF	5,000 (345)	126976

#### JIC Female Swivel Straight Adapter Fittings

Useful for mounting a pressure gauge to an Electric Grease Jockey (EGJ) system.

Female Thread (A)	Female Thread (B)	Maximum Pressure PSI (Bar)	Part Number
JIC-6	1/4 in-18 NPT female	5,000 (345)	133645

#### JIC Female Swivel Union Fittings

Female threads both include swivel nut.

Female Thread (A)	Female Thread (B)	Maximum Pressure PSI (Bar)	Part Number
JIC-8	JIC-8	5,500 (379)	123896
JIC-10	JIC-10	5,500 (379)	123897

## Ordering Information

### JIC Fittings – Carbon Steel

#### JIC Female Swivel by Male Straight Adapter Fittings

Female thread includes swivel nut.

Female Thread	Male Thread	Maximum Pressure PSI (Bar)	Part Number
JIC-4	1/8 in-27 NPT	6,000 (414)	17L875
JIC-4	1/4 in-18 NPT	6,000 (414)	17K615
JIC-5	1/8 in-27 NPT	5,000 (345)	117635
JIC-5	1/4 in-18 NPT	6,000 (414)	122963
JIC-6	1/8 in-27 NPT	5,000 (345)	117634
JIC-6	1/4 in-18 NPT	6,000 (414)	122721
JIC-6	1/4 in-18 NPT	5,000 (345)	117506
JIC-6	3/8 in-18 NPT	5,000 (345)	17V731
JIC-6	3/8 in-18 NPT	5,000 (345)	126327
JIC-6	1/2 in-14 NPT	6,000 (414)	126432
JIC-6	7/16 in-20 SAE-ORB	6,000 (414)	122717
JIC-8	1/2 in-14 NPT	5,000 (345)	126329
JIC-8	7/8 in-14 SAE-ORB	5,000 (345)	17U325
JIC-10	1/2 in-14 NPT	5,000 (345)	126330
JIC-16	1 in-11.5 NPT	3,600 (248)	124434

#### JIC Expanding Bushings

Male Thread	Female Thread	Maximum Pressure PSI (Bar)	Part Number
JIC-5	JIC-8	5,000 (345)	117502
JIC-6	JIC-10	5,000 (345)	117677
JIC-6	JIC-8	5,000 (345)	122398
JIC-4	JIC-8	6,000 (414)	17L898
JIC-4	JIC-10	5,000 (345)	17L899
JIC-8	JIC-12	5,000 (345)	17U385

#### JIC 90° Street Elbows

Male Thread	Female Thread	Maximum Pressure PSI (Bar)	Part Number
JIC-3	JIC-3	5,000 (345)	124405
JIC-4	JIC-4	7,500 (517)	122718
JIC-6	JIC-6	6,000 (414)	122719
JIC-8	JIC-8	5,000 (345)	122967
JIC-8	JIC-8	5,000 (345)	16W608

#### JIC 90° Bulkhead Elbows

Male Thread (A)	Male Thread (B)	Maximum Pressure PSI (Bar)	Part Number
JIC-8	JIC-8	6,000 (414)	122400
JIC-8	JIC-8	6,000 (414)	17G704

# Installation Accessories – Steel JIC Fittings

## Ordering Information

### JIC Fittings – Carbon Steel

#### JIC Male 90° Adapter Elbows

Male Thread (A)	Male Thread (B)	Maximum Pressure PSI (Bar)	Part Number
JIC-4	1/8 in-27 NPT	–	556763
JIC-4	1/4 in-18 NPT	–	556764
JIC-4	7/16 in-20 SAE-ORB (Fluoroelastomer)	6,000 (414)	122711
JIC-5	1/4 in-18 NPT	6,000 (414)	131236
JIC-6	1/4 in-18 NPT	6,000 (414)	122311
JIC-6	3/8 in-18 NPT	6,000 (414)	120064
JIC-6	3/8 in-18 NPT	6,000 (414)	261840
JIC-6	7/16 in-20 SAE-ORB (Buna-N)	–	110792
JIC-6	7/16 in-20 SAE-ORB (Buna-N)	4,500 (310)	19B332
JIC-6	9/16 in-18 SAE-ORB (Buna-N)	6,000 (414)	129755
JIC-6 (Long Leg)	9/16 in-18 SAE-ORB (Fluoroelastomer)	5,000 (345)	124941
JIC-6 (Long Leg)	9/16 in-18 SAE-ORB (Fluoroelastomer)	6,000 (414)	16V434
JIC-6	3/4-16 SAE-ORB	6,000 (414)	17U308
JIC-8	3/8 in-18 NPT	5,000 (345)	125926
JIC-8	3/8 in-18 NPT	6,000 (414)	125643
JIC-8	1/2 in-14 NPT	5,000 (345)	121486
JIC-8	1/2 in-14 NPT	6,000 (414)	123094
JIC-8	3/4 in-14 NPT	4,000 (276)	124905
JIC-8	9/16 in-18 SAE-ORB (Buna-N)	5,000 (345)	121321
JIC-8	9/16 in-18 SAE-ORB (Buna-N)	5,500 (379)	118896
JIC-8	3/4 in-16 SAE-ORB (Buna-N)	5,000 (345)	121312
JIC-8	3/4 in-16 SAE-ORB (Buna-N)	6,000 (414)	122968
JIC-8	7/8 in-14 SAE-ORB (Buna-N)	5,000 (345)	17U319
JIC-8	7/8 in-14 SAE-ORB (Buna-N)	5,500 (379)	122520
JIC-12	3/4 in-14 NPT	4,000 (276)	104099
JIC-12	1 in-11.5 NPT	4,000 (276)	C20694
JIC-16	1/2 in-14 NPT	4,000 (276)	120804
JIC-16	1 in-11.5 NPT	4,000 (276)	C20686

#### JIC Male x NPT Female 90° Adapter Elbows

Male Thread	Female Thread	Maximum Pressure PSI (Bar)	Part Number
JIC-8	1/2 in-14 NPTF	3,000 (207)	16W609
JIC-10	1/2 in-14 NPTF	3,000 (207)	16W610

## Ordering Information

### JIC Fittings – Carbon Steel

#### JIC Male 45° Adapter Elbows

Male Thread (A)	Male Thread (B)	Maximum Pressure PSI (Bar)	Part Number
JIC-5	1/4 in-18 NPT	6,000 (414)	123788
JIC-6	1/4 in-18 NPT	6,000 (414)	123787
JIC-6	1/2 in-14 NPT	6,000 (414)	126431
JIC-6	9/16 in-18 SAE-ORB (Fluoroelastomer)	5,000 (345)	24P548
JIC-6	9/16 in-18 SAE-ORB (Buna-N)	5,000 (345)	126961
JIC-8	3/8 in-18 NPT	5,000 (345)	122533
JIC-8	1/2 in-14 NPT	5,000 (345)	117556
JIC-8	3/4 in-16 SAE-ORB (Fluoroelastomer)	6,000 (414)	17Y236
JIC-10	1/2 in-14 NPT	5,000 (345)	117557
JIC-10	3/4 in-16 SAE-ORB (Fluoroelastomer)	5,000 (345)	17Y235

#### JIC Male x Female 45° Elbows

Male Thread	Female Thread	Maximum Pressure PSI (Bar)	Part Number
JIC-5	JIC-5	5,000 (345)	127128
JIC-6	JIC-6	5,000 (345)	127129
JIC-6	JIC-6	5,000 (345)	129872
JIC-8	JIC-8	6,000 (414)	123528



129872

#### JIC Male (2) x NPT Male Run Adapter Tees

Male Thread (2)	NPT Thread	Maximum Pressure PSI (Bar)	Part Number
JIC-6	3/8 in Run	6,000 (414)	131817
JIC-8	1/2 in-14 NPTF	6,000 (414)	17V389
JIC-16	1 in Run	5,000 (345)	124408

#### JIC Female Caps

Thread	Maximum Pressure PSI (Bar)	Part Number
JIC-4	5,000 (345)	127325
JIC-6	5,000 (345)	127326
JIC-8	6,000 (414)	123140
JIC-8	–	120112
JIC-12	–	120170

#### JIC Male x NPT Male Bulkhead Fittings

Male Thread (A)	Male Thread (B)	Maximum Pressure PSI (Bar)	Part Number
JIC-8 with nut	3/8 in-18 NPTF	6,000 (414)	122401
JIC-8 with nut	1/2 in-14 NPTF	6,000 (414)	16W611

# Installation Accessories – Steel JIC Fittings

## Ordering Information

### JIC O-Ring Face Seal (ORFS) Adapter Fittings

#### JIC Male Straight Adapter

Male Thread (A)	Male Thread (B)	Maximum Pressure PSI (Bar)	Part Number
9/16-18 SAE-ORFS (Buna-N)	1/8 in NPT Male	6,000 (414)	2009011

#### JIC Male 90° Adapter Elbow

Male Thread (A)	Male Thread (B)	Maximum Pressure PSI (Bar)	Part Number
9/16-18 SAE-ORFS (Buna-N)	1/8 in NPT Male	6,000 (414)	2009010

## Ordering Information

### Pipe Thread Stainless Steel Fittings

#### 45° Street Elbows

Male Thread	Female Thread	Maximum Pressure PSI (Bar)	Part Number
1/4 in-18 NPT	1/4 in-18 NPT	5,000 (345)	113933

#### 90° Street Elbows

Male Thread	Female Thread	Maximum Pressure PSI (Bar)	Part Number
1/8 in-27 NPT	1/8 in-27 NPT	5,000 (345)	128054
1/8 in-27 NPTF	1/8 in-27 NPTF	5,000 (345)	502820
3/8 in-18 NPT	3/8 in-18 NPT	4,000 (276)	112026
3/4 in-14 NPT	3/4 in-14 NPT	3,000 (207)	122763
1 in-11.5 NPT	1 in-11.5 NPT	3,000 (207)	U70234
1.25 in-11.5 NPT	1.25 in-11.5 NPT	6,000 (414)	119900

#### 90° Street Elbows – Zero Radius

Male Thread	Female Thread	Maximum Pressure PSI (Bar)	Part Number
1/8 in-27 NPT	1/8 in-27 NPT	-	297085
1/4 in-18 NPTF	1/4 in-18 NPSF	-	560531
1/4 in-18 NPT	1/4 in-18 PTF SAE Short	9,000 (620)	166866
1/2 in-14 NPT	1/2 in-14 NPT	4,500 (310)	166242

#### 90° Male Elbows

Male Thread (A)	Male Thread (B)	Maximum Pressure PSI (Bar)	Part Number
3/8 in-18 NPT	1/4 in-18 NPT	5,000 (345)	114504
3/8 in-18 NPT	3/8 in-18 NPT	5,000 (345)	15E279
1/2 in-14 NPT	1/2 in-14 NPT	5,000 (345)	114506

#### Hex Couplings

Female Thread	Maximum Pressure PSI (Bar)	Part Number
1/4 in-18 NPT	5,000 (345)	110336
1/2 in-14 NPT	3,000 (207)	124586

#### Hex Nipples – Standard and Reducing

Male Thread (A)	Male Thread (B)	Maximum Pressure PSI (Bar)	Part Number
1/4 in-18 NPT	1/8 in-27 NPT	6,000 (414)	111643
1/4 in-18 NPT	1/4 in-18 NPT	7,200 (496)	121907
1/2 in-14 NPT	1/2 in-14 NPT	5,000 (345)	114373
3/4 in-14 NPT	1/2 in-14 NPT	7,250 (500)	16R883
3/4 in-14 NPT	3/4 in-14 NPT	7,250 (500)	16R882
1 in-11.5 NPT	1/2 in-14 NPT	5,000 (345)	503086
1 in-11.5 NPT	3/4 in-14 NPT	6,000 (414)	131525
1 in-11.5 NPT	3/4 in-14 NPT	5,400 (372)	15M805
1 in-11.5 NPT	1 in-11.5 NPT	6,000 (414)	131524

# Installation Accessories – Stainless Steel Fittings

## Ordering Information

### Pipe Thread Stainless Steel Fittings

#### Reducing Bushings

Male Thread	Female Thread	Maximum Pressure PSI (Bar)	Part Number
3/8 in-18 NPT	1/4 in-18 NPT	3,000 (207)	125214
1/2 in-14 NPT	1/4 in-18 NPT	3,000 (207)	122656
1/2 in-14 NPT	1/4 in-18 NPT	6,000 (414)	122767
3/4 in-14 NPT	1/4 in-18 NPT	6,000 (414)	15M861
3/4 in-14 NPT	1/4 in-18 NPT	5,000 (345)	516308
3/4 in-14 NPT	3/8 in-18 NPT	3,000 (207)	500352
3/4 in-14 NPT	1/2 in-14 NPT	6,000 (414)	16C475
3/4 in-14 NPT	1/2 in-14 NPT	6,000 (414)	502033
1 in-11.5 NPT	3/4 in-14 NPT	3,000 (207)	502851
1.25 in-11.5 NPT	3/4 in-14 NPT	5,000 (345)	127119

#### Expanding Bushings

Male Thread	Female Thread	Maximum Pressure PSI (Bar)	Part Number
1/4 in-18 NPT	3/8 in-18 NPT	5,000 (345)	512351
1/4 in-18 NPT	1/2 in-14 NPT	5,200 (359)	16H491
1/4 in-18 NPT	1/2 in-14 NPT	3,000 (207)	124814
1/4 in-18 NPT	3/4 in-14 NPT	4,300 (296)	16J975
3/8 in-18 NPT	1/2 in-14 NPT	3,000 (207)	123024
3/4 in-14 NPT	1 in-11.5 NPT	3,600 (248)	15X886

#### Tee Fittings – Male

Male Threads (3)	Maximum Pressure PSI (Bar)	Part Number
3/8 in-18 NPT	7,500 (517)	116400
3/4 in-14 NPT	3,000 (207)	122844

#### Tee Fittings – Male Branch

Male Thread	Maximum Pressure PSI (Bar)	Part Number
1/4 in-18 NPT	5,000 (345)	185281
1/2 in-14 NPT	3,500 (241)	517434

#### Tee Fittings – Male Run (Street Tees)

Male Thread	Maximum Pressure PSI (Bar)	Part Number
1/4 in-18 NPT	5,000 (345)	125215
3/8 in-18 NPTF	4,000 (276)	108673
1/2 in-14 NPT	3,000 (207)	124844
3/4 in-14 NPT	3,000 (207)	16C637
3/4 in-14 NPT	3,000 (207)	123514

#### Cross Fittings – FFFF Port

Female Thread	Maximum Pressure PSI (Bar)	Part Number
1/4 in-18 NPT	5,000 (345)	110191

#### Plugs

Thread	Head Shape	Maximum Pressure PSI (Bar)	Part Number
1/8 in-27 NPTF	None (Socket)	7,200 (496)	555457
1/8 in-28 BSPT	None (Socket)	–	114172
1/4 in-18 PTF SAE short	None (Socket)	–	101970

## Ordering Information

### Swivel Adapters

- Female NPSM swivels allow for easy clocking of the fitting.
- Not a “live” swivel; position is stationary after tightened.

### Straight Stainless Steel Swivel Adapters, mbf

Rigid Thread (Male)	Swivel Thread (Female)	Maximum Pressure PSI (Bar)	Part Number
1/4 in	1/4 in	10,000 (689)	24W865
3/8 in	1/4 in	6,000 (414)	121908
3/4 in	1/2 in	3,500 (241)	123980

### Straight Stainless Steel Swivel Adapters, fbe

Rigid End (Female)	Swivel Thread (Female)	Maximum Pressure PSI (Bar)	Part Number
3/4 in	3/4 in	4,000 (276)	15X983

### 90° Elbow Stainless Steel Swivel Adapters, mbf

Rigid Thread (Male)	Swivel Thread (Female)	Maximum Pressure PSI (Bar)	Part Number
1/8 in	1/4 in	5,000 (345)	114446
3/8 in	3/8 in	5,000 (345)	207123
1/2 in	1/2 in	5,000 (345)	114874

### 45° Elbow Stainless Steel Swivel Adapters, mbf

Rigid Thread (Male)	Swivel Thread (Female)	Maximum Pressure PSI (Bar)	Part Number
3/8 in	3/8 in	4,600 (317)	209029

# Installation Accessories – Stainless Steel JIC Fittings

## Ordering Information

### JIC Fittings – Stainless Steel

#### JIC Male 90° Adapter Elbows

Male Thread (A)	Male Thread (B)	Maximum Pressure PSI (Bar)	Part Number
JIC-5	1/4 in-18 NPT	–	114247
JIC-5	3/4 in-16 SAE-ORB (Buna-N)	5,000 (345)	123108
JIC-6	3/8 in-18 NPT	5,000 (345)	114484
JIC-6	1/4 in-18 NPT	5,000 (345)	122786
JIC-8	3/8 in-18 NPT	4,000 (276)	125297
JIC-8	3/8 in-18 NPT	6,000 (414)	125494
JIC-8	1/4 in-18 NPT	6,000 (414)	124813
JIC-8	1/2 in-14 NPT	6,000 (414)	124885
JIC-8	3/4 in-16 SAE-ORB (Fluoroelastomer)	6,000 (414)	126565
JIC-16	1/2 in-14 NPT	4,000 (276)	U70588

#### JIC 90° Street Elbows

Male Thread	Female Thread	Maximum Pressure PSI (Bar)	Part Number
JIC-5	JIC-5	6,000 (414)	122715

#### JIC 45° Street Elbows

Male Thread	Female Thread, with Swivel	Maximum Pressure PSI (Bar)	Part Number
JIC-4	JIC-4	–	121041
JIC-6	JIC-6	–	121042
JIC-8	JIC-8	–	121043
JIC-12	JIC-12	–	121044

#### JIC Male 45° Adapter Elbows

Male Thread (A)	Male Thread (B)	Maximum Pressure PSI (Bar)	Part Number
JIC-8	1/2 in-14 NPT	–	123106
JIC-10	1/2 in-14 NPT	–	123107

#### JIC Female Straight Adapter Fittings

Female Thread (A)	Female Thread (B)	Maximum Pressure PSI (Bar)	Part Number
JIC-6	1/4 in-18 NPT	5,000 (345)	124820
JIC-6	1/2 in-14 NPT	5,000 (345)	124152
JIC-10	1/2 in-14 NPT	5,000 (345)	126979

#### JIC Nipples – Standard and Reducing

Male Thread (A)	Male Thread (B)	Maximum Pressure PSI (Bar)	Part Number
JIC-3	JIC-3	5,000 (345)	124845
JIC-4	JIC-4	9,000 (621)	123553
JIC-5	JIC-5	7,200 (496)	124726
JIC-6	JIC-6	7,200 (496)	125779
JIC-8	JIC-6	7,200 (496)	126366
JIC-8	JIC-8	7,200 (496)	125781
JIC-12	JIC-8	3,500 (241)	129133
JIC-12	JIC-12	6,000 (414)	124435
JIC-16	JIC-16	4,800 (331)	126418

## Ordering Information

### JIC Fittings – Stainless Steel

#### JIC Male Straight Adapter Nipples

Male Thread (A)	Male Thread (B)	Maximum Pressure PSI (Bar)	Part Number
JIC-3	1/4 in-18 NPT	6,000 (414)	124846
JIC-4	1/8 in-27 NPT	6,000 (414)	124803
JIC-4	1/4 in-18 NPT	6,000 (414)	124961
JIC-5	1/4 in-18 NPT	4,500 (310)	123596
JIC-5	1/4 in-18 NPT	6,000 (414)	122727
JIC-5	7/16 in-20 SAE-ORB (Buna-N)	6,000 (414)	124221
JIC-6	1/4 in-18 NPT	4,500 (310)	123597
JIC-6	1/4 in-18 NPT	6,000 (414)	122991
JIC-6	3/8 in-18 NPT	5,000 (345)	112100
JIC-6	3/4 in-16 SAE-ORB (Buna-N)	6,000 (414)	126170
JIC-8	1/4 in-18 NPT	4,500 (310)	123598
JIC-8	3/4 in-14 NPT	2,500 (172)	125296
JIC-8	1/2 in-14 NPT	6,000 (414)	16C398
JIC-8	3/8 in-18 NPT	6,000 (414)	16C399
JIC-8	3/4 in-16 SAE-ORB (Fluoroelastomer)	7,200 (496)	126562
JIC-10	1/4 in-18 NPT	4,500 (310)	123599
JIC-10	1/2 in-14 NPT	3,000 (207)	503931
JIC-12	1/4 in-18 NPT	5,000 (345)	116712
JIC-12	3/4 in-14 NPT	5,000 (345)	123417
JIC-12	3/4 in-14 NPT	5,000 (345)	15M863
JIC-12	1 in-11.5 NPT	5,000 (345)	123136
JIC-16	3/4 in-14 NPT	5,000 (345)	124315
JIC-16	1 in-11.5 NPT	4,500 (310)	U70933

#### JIC NPT Male x JIC Female Straight Adapter Fittings

Male Thread	Female Thread	Maximum Pressure PSI (Bar)	Part Number
1/4 in-18 NPT	JIC-4	6,000 (414)	126243
1/4 in-18 NPT	JIC-5	6,000 (414)	122737
1/4 in-18 NPT	JIC-5	5,000 (345)	262205
1/4 in-18 NPT	JIC-6	5,000 (345)	262206
1/4 in-18 NPT	JIC-6	5,000 (345)	122961
1/4 in-18 NPT	JIC-8	5,000 (345)	262208
1/4 in-18 NPT	JIC-10	5,000 (345)	262210
1/2 in-14 NPT	JIC-8	5,000 (345)	127600
3/4 in-14 NPT	JIC-12	5,000 (345)	124433

#### JIC Male x NPT Female Straight Adapter Fittings

Male Thread	Female Thread	Maximum Pressure PSI (Bar)	Part Number
JIC-6	1/4 in-18 NPTF	6,000 (414)	124967
JIC-8	1/4 in-18 NPT	4,500 (310)	129134
JIC-8	1/2 in-14 NPTF	5,000 (345)	126975

# Installation Accessories – Stainless Steel JIC Fittings

## Ordering Information

### JIC Fittings – Stainless Steel

#### JIC Reducing Bushings

Male Thread	Female Thread	Maximum Pressure PSI (Bar)	Part Number
JIC-12	JIC-8	3,500 (241)	17T211

#### JIC Expanding Bushings

Male Thread	Female Thread	Maximum Pressure PSI (Bar)	Part Number
JIC-8	JIC-12	3,500 (241)	128442
JIC-5	JIC-8	5,000 (345)	16A361
JIC-6	JIC-10	5,000 (345)	16A362

#### JIC Bulkhead Elbow Fitting

- SST elbow with 1.25 inch (32 mm) hex head
- Use with nut 102300 and washer 114830 (nut and washer are carbon steel)

Male Thread	Female Thread	Maximum Pressure PSI (Bar)	Part Number
JIC-6 (Long Leg)	3/8 in-18 NPT	5,000 (345)	192889

Incoming flow pushes the ball from the valve seat, compressing the spring and permitting lubricant to flow through the check valve to the lube points. When flow stops, the spring expands, re-seating the ball and creating a positive seal. Compact and easy to install. Include a symbol stamped on the body to indicate flow direction.

## Single Ball Check Valves

- Designed with the standard ball and spring principle.
- Positive seal prevents leakage and backflow.

## Typical Applications

- Compressor lubrication systems
- Hydraulic systems

## Typical Fluids

- Oil or grease

## Technical Specifications

Thread Type	Maximum Temperature	Maximum Operating Pressure	Materials			
			Body	Spring	Ball	O-Ring
Pipe Thread	500°F (206°C)	5,000 PSI (345)	Steel	Steel	Steel	N/A
SAE-ORB	250°F (121°C)	3,500 PSI (242)	303 SST	Steel	Steel	See Below
BSPP	250°F (121°C)	5,000 PSI (345)	Steel	Steel	Steel	See Below

## Ordering Information

### Pipe Thread Single Ball Check Valves

#### Outlet Check Valves

- May be installed in the outlet ports of MSP, MHH and MX/MXP divider valves.
- Male inlet, female outlet.

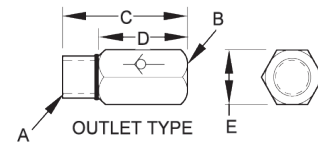

Part Number	Male Inlet Thread (A)	Female Outlet Thread (B)	Nominal Cracking Pressure PSI (bar)	Dimensions in (mm)		
				Length (C)	Length (D)	Hex (E)
563195	1/8-27 NPTF	1/8-27 NPSF	10 (0.7)	1.28 (32.5)	0.91 (23.0)	0.56 (14.2)
563196	1/8-27 NPTF	1/8-27 NPSF	35 (2.4)	1.28 (32.5)	0.91 (23.0)	0.56 (14.2)
563197	1/8-27 NPTF	1/8-27 NPSF	130 (9.0)	1.28 (32.5)	0.91 (23.0)	0.56 (14.2)
563198	1/8-27 NPTF	1/8-27 NPSF	250 (17.2)	1.28 (32.5)	0.91 (23.0)	0.56 (14.2)
563206	1/4-18 NPTF	1/4-18 NPSF	10 (0.7)	1.63 (41.4)	1.13 (28.7)	0.69 (17.5)
563207	1/4-18 NPTF	1/4-18 NPSF	35 (2.4)	1.63 (41.4)	1.13 (28.7)	0.69 (17.5)

#### Inlet Check Valves

- Typically installed in the inlet ports of MSP, MHH and MX/MXP divider valves, or into a lubrication point.
- Female inlet, male outlet.
- "Reverse" check valves.

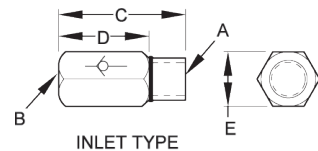

Part Number	Female Inlet Thread (A)	Male Outlet Thread (B)	Nominal Cracking Pressure PSI (bar)	Dimensions in (mm)		
				Length (C)	Length (D)	Hex (E)
563199	1/8-27 NPSF	1/8-27 NPTF	15 (1.0)	1.31 (33.3)	0.94 (23.8)	0.56 (14.2)
563200	1/8-27 NPSF	1/8-27 NPTF	35 (2.4)	1.31 (33.3)	0.94 (23.8)	0.56 (14.2)
563201	1/8-27 NPSF	1/8-27 NPTF	60 (4.1)	1.31 (33.3)	0.94 (23.8)	0.56 (14.2)
563210	1/4-18 NPSF	1/4-18 PTF SAE short	10 (0.7)	1.75 (44.5)	1.25 (31.8)	0.69 (17.5)
563211	1/4-18 NPSF	1/4-18 PTF SAE short	35 (2.4)	1.75 (44.5)	1.25 (31.8)	0.69 (17.5)

# Installation Accessories – Check Valves

## Ordering Information

### Single Ball Check Valves (Cont.)

#### SAE-ORB Thread

##### Outlet Check Valves

Part Number	Male Inlet Thread (A)	Female Outlet Thread (B)	Nominal Cracking Pressure PSI (bar)	Dimensions in (mm)			O-Ring Material
				Length (C)	Length (D)	Hex (E)	
563054	7/16-20	7/16-20	35 (2.4)	1.56 (39.7)	1.20 (30.5)	0.63 (15.9)	Buna-N
563055	9/16-18	9/16-18	35 (2.4)	1.69 (42.8)	1.30 (33.0)	0.75 (19.1)	Fluoroelastomer

#### BSPP “G” Thread

##### Outlet Check Valve

Part Number	Male Inlet Thread (A)	Female Outlet Thread (B)	Nominal Cracking Pressure PSI (bar)	Dimensions in (mm)			O-Ring Material
				Length (C)	Length (D)	Hex (E)	
258299	1/8 in-28	1/8 in-28	35 (2.4)	1.27 (32.3)	0.97 (24.6)	0.63 (15.9)	Buna-N

##### Inlet Check Valves

Part Number	Female Inlet Thread (A)	Male Outlet Thread (B)	Nominal Cracking Pressure PSI (bar)	Dimensions in (mm)			O-Ring Material
				Length (C)	Length (D)	Hex (E)	
563057	1/4 in-19	1/4 in-19	35 (2.4)	1.79 (45.5)	1.35 (34.3)	1.0 (25.4)	Buna-N (Buna-N)

### Double Ball Check Valves

- Designed for high pressure applications where reverse leakage must be kept to a minimum.
- Also used to isolate parts of circuits and to prevent fluid drainage due to gravity.
- A relatively stiff bias spring in these valves serves to increase the reliability of circuits designed to detect a blockage or reduction in lubricant flow.

#### Typical Applications

- Compressor lubrication systems
- Hydraulic systems

#### Technical Specifications

Maximum Temperature	400°F (204°C)
Maximum Operating Pressure	8,000 PSI (552 bar)
Nominal Cracking Pressure	110 PSI (7.6 bar)
Materials	316 SST Body, 440 SST Balls, SST Spring, Fluoroelastomer O-Ring

#### Typical Fluids

- Oil or grease

## Ordering Information

### Double Ball Check Valves

Part Number	Female Inlet Thread (A)	Male Outlet Thread (B)	Dimensions in (mm)	
			Length (C)	Length (E)
562647	1/8-27 NPTF	1/8-27 NPTF	3.0 (76.2)	0.75 (19.1)
562649	1/4-18 NPTF	1/8-27 NPTF	3.2 (81.5)	0.75 (19.1)

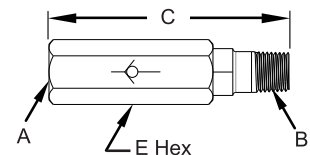

# Installation Accessories – Soft Seat Check Valves – Stainless Steel

## Soft Seat Check Valves – Stainless Steel

- A poppet and soft ball check design improves check valve reliability.
- The “double ball” check valve contains a poppet and soft ball check, as well as a conventional steel ball back-up for added protection.
- Provides optimum sealing against reverse flow.

## Typical Applications

- Lubrication systems
- Hydraulic systems

## Technical Specifications

Maximum Temperature	400°F (204°C)
Maximum Operating Pressure	7,500 PSI (517 bar)
Materials	316 SST Body, Steel Springs, See below for ball(s)

## Typical Fluids

- Oil or grease

## Ordering Information

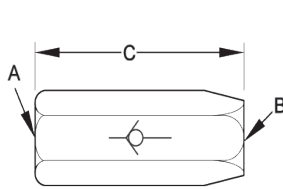

Style A

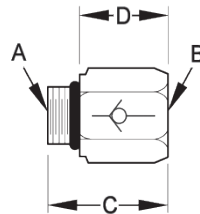

Style B

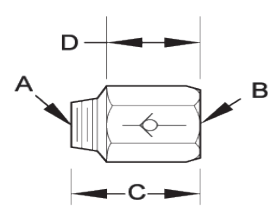

Style C

## Soft Seat Check Valves – Stainless Steel

### Style A

- Female both ends.
- Tapered at outlet end to help identify flow direction.
- 50 PSI (3.5 bar) nominal cracking pressure.

Part Number	Type	Female Inlet Thread (A)	Female Outlet Thread (B)	Dimensions in (mm)		Ball Material
				Length (C)	Hex	
563046	Single	1/4-18 NPSF	1/4-18 NPSF	1.94 (49.3)	0.75 (19.1)	Fluoroelastomer
563060	Double	1/4-18 NPSF	1/4-18 NPSF	2.41 (61.2)	0.75 (19.1)	Buna-N*
563061	Double	1/4-18 NPSF	1/4-18 NPSF	2.41 (61.2)	0.75 (19.1)	Fluoroelastomer*

\*Second ball is made of chrome steel.

### Style B

- Includes Buna-N O-Ring at base of male thread.
- 32 PSI (2 bar) nominal cracking pressure.

Part Number	Male Inlet Thread (A)	Female Outlet Thread (B)	Dimensions in (mm)			Ball Material
			Length (C)	Length (D)	Hex	
563052	7/16-20 SAE Male	7/16-20 SAE	1.56 (39.6)	1.20 (30.4)	0.63 (15.9)	Fluoroelastomer

### Style C

- 50 PSI (3.5 bar) nominal cracking pressure.

Part Number	Male Inlet Thread (A)	Female Outlet Thread (B)	Dimensions in (mm)		
			Length (C)	Length (D)	Hex
563048	1/8-27 NPTF	1/8-27 NPSF	1.13 (28.7)	0.94 (23.9)	0.56 (14.2)

# Installation Accessories – Soft Seat Check Valves – Carbon Steel

## Soft Seat Check Valves – Carbon Steel

- A poppet and soft ball check design improves check valve reliability.
- The “double ball” check valve contains a poppet and soft ball check, as well as a conventional steel ball back-up for added protection.
- Provides optimum sealing against reverse flow.

### Typical Applications

- Lubrication systems
- Hydraulic systems

### Technical Specifications

Maximum Temperature	400°F (204°C)
Maximum Operating Pressure	100 PSI (6.9 bar)
Cracking Pressure	32 PSI (2 bar)
Materials	Steel Body and Spring, Fluoroelastomer Ball

### Typical Fluids

- Oil or grease

## Ordering Information

## Soft Seat Check Valves – Carbon Steel

### Style C

- 50 PSI (3.5 bar) nominal cracking pressure.

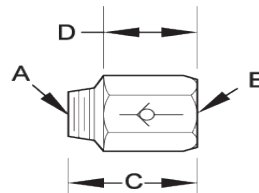

Part Number	Female Inlet Thread (A)	Female Outlet Thread (B)	Dimensions in (mm)		
			Length (C)	Length (D)	Hex
563048	1/8-27 NPTF	1/8-27 NPSF	1.13 (28.7)	0.94 (23.9)	0.56 (14.2)

# Installation Accessories – Twin Tandem Check Valves

## Twin Tandem Check Valves

- Incorporates both a garter type check valve and a standard ball and spring type check valve.
- The garter check valve has a soft seat elastic garter band that permits uninterrupted flow and seals unwanted back flow.

## Technical Specifications

Maximum Temperature	400°F (204°C)
Maximum Operating Pressure	5,000 PSI (345 bar)
Nominal Cracking Pressure	75 ± 15 psi (5.2 ± 1.0 bar)
Materials	303 SST Body, 440 SST Ball, 302 SST Spring, Aluminum Gaskets, Fluoroelastomer Garter

## Typical Applications

- Lubrication systems
- Hydraulic systems

## Typical Fluids

- Oil or grease

## Ordering Information

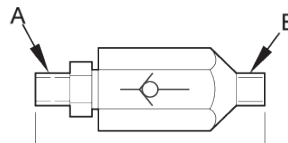

## Tandem Twin Check Valves

Part Number	Male Inlet Thread (A)	Male Outlet Thread (B)	Dimensions in (mm)	
			Length	Hex
563203	1/4-18 PTF SAE short	1/8-27 NPTF	2.25 (57.2)	0.68 (17.1)
563205	1/4-18 PTF SAE short	1/4-18 NPTF	2.25 (57.2)	0.68 (17.1)

Note: for applications requiring a 90 degree connection, order 1/4 in elbow fitting 560531 separately.

# Installation Accessories – Brass Double Ball Check Valve

## Brass Double Ball Check Valve

- Typically used as inlet check valve.
- Two of the conventional spring & ball type checks are combined to provide maximum protection against system back flow/leakage.

### Technical Specifications

Maximum Temperature	500°F (260°C)
Maximum Operating Pressure	3,800 PSI (262 bar)
Nominal Cracking Pressure	40 +/- 20 PSI (2.8 +/- 1.4 bar)
Materials	Brass Body, 440 SST Balls, 302 SST Springs

### Typical Applications

- Lubrication systems
- Hydraulic systems

### Typical Fluids

- Oil or grease

## Ordering Information

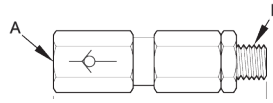

### Double Brass Ball Check Valve

Part Number	Male Inlet Thread (A)	Male Outlet Thread (B)	Dimensions in (mm)	
			Length	Hex
563058	1/4 in NPSF	1/4-18 PTF SAE short	3.56 (90.4)	0.75 (19.1)

## Pressure Sensors for Lubrication Systems

Provide positive indication to the lubrication controller when a Parallel system has achieved the required pressure.  
Can also be used to trigger a high pressure alarm when used in Series Progressive systems (requires capable controller).

### Ordering Information

#### Pipe Thread

#### Pressure Switches

- Options for pressures up to 5,800 PSI.
- May be wired Normally Open or Normally Closed.



24K414

Part Number	Rising Pressure Range PSI (Bar)	Pressure Connection	Electrical Connection	Enclosure Rating	Approvals	Switch Type	Voltage Range	Special Features
24K414	290 to 5,800 (20 to 400)	1/4 NPT male	M12	IP67	UL, CE	PNP transistor	9.6 to 32 VDC	M12 connector allows for plug-and-play wiring to G3 Max via cable 124333 (sold separately); LED lights visually display pressure switch status. Instruction Manual number 3A1827.
557829	400 to 4,700 (28 to 324)	1/4 NPT male	Flying Leads – 5 ft (1.5 m)	NEMA 4	UL, CE	SPDT	Up to 30 VDC; Up to 250 VAC	Factory set at 1,150 PSI (79 Bar); replacement part for Modu-Flo kit 563328, and Miniature Meter-Flo (MMF) pump packages. Instruction Manual number 3A0471.
115124	280 to 3,000 (19 to 207)	1/4 NPT female	Flying Leads – 18 in (46 cm)	NEMA 3	CE	SPDT	Up to 250 VDC; Up to 480 VAC	Factory set at 2,500 PSI (172 Bar)
24N181	580 to 5,800 (40 to 400)	1/4 NPT female	DIN Form A	NEMA 4, IP65	CE	SPDT	Up to 24 VDC; Up to 250 VAC	Factory set at 3,500 PSI (241 Bar)
25U286	3,500 (241)	1/4 or 3/8 NPT male	DT04-3P	NEMA 6, IP67	UL, CSA, CE, CRN, RoHS	SPDT	Up to 24 VDC; Up to 125 VAC	Factory set at 3,500 PSI (241 Bar), non-adjustable, 1/4 NPT male. Kit includes switch, mating 10 ft (3 m) wiring harness, and 3/8 NPT male x 1/4 NPT female adapter fitting.

#### Pressure Transducers

- Analog signal communicates real time pressure level.
- Compatible with G3 Max Gen 2 pumps (AC and DC), and GLC X lubrication controller.

Part Number	Rising Pressure Range PSI (Bar)	Pressure Connection	Electrical Connection	Enclosure Rating	Approvals	Output Signal	Excitation Voltage	Special Features
25U285	0 to 5,000 (0 to 345)	3/8 NPT male – mates to GL-1 and GCI injectors	DT04-3P	NEMA 4X, IP67	CE, RoHS, UL	0.5 to 4.5 VDC	9 to 36 VDC	Use with GLC X controller to add analog pressure sensing to EDS and Fire-Ball pumps! Also compatible with G3 Max Gen 2 pumps. Kit includes transducer and mating 10 ft (3 m) wiring harness. G3 Max requires connector 124594.
2010651	0 to 5,000 (0 to 345)	1/4 NPT male – mates to GL-32 and GL-43 injectors	M12	NEMA 6X, IP67	CE, RoHS, UL	0.5 to 4.5 VDC	9 to 36 VDC	M12 connector pin assignments match "P" input of the G3 Max Gen 2 pumps; use cable 124333 for easy, plug-and-play wiring. Use cable 126331 to connect to GLC X controller.

# Installation Accessories – Pressure Gauges

## Ordering Information



115523



100960



557864

### Air Pressure Gauges

Part Number	Scale PSI (bar/MPa)	Dial Diameter in (mm)	Fill	Case Material	Fitting Material	Fitting Location	Graco Branded?	Application Notes
110319	0-200 (14/1.4)	1.5 (40)	Dry		Brass	Bottom	Yes	1/8 in NPT
100960	0-200 (14/1.4)	2 (50)	Dry		Brass	Bottom	Yes	1/4 in NPT
24E691	0-200 (14/1.4)	2 (50)	Dry		Brass	Bottom	Yes	1/4 in NPT, suitable for use with air and oil
116383	0-160 (-/-)	0.91(23)	Dry	Black ABS	Brass	Center-Back	No	1/8 in NPT, “micro” air pressure gauge
127379	0-160 (11/-)	1.5 (40)	Dry			Center-Back	No	1/8 in NPT
101689	0-200 (14/1.4)	2 (50)	Dry		Brass	Center-Back	Yes	1/4 in NPT

### Oil and Grease Pressure Gauges

- 1/4 in NPT male thread

Part Number	Scale PSI (bar/MPa)	Dial Diameter in (mm)	Fill	Case Material	Fitting Material	Fitting Location	Graco Branded?	Application Notes
24E691	0-200 (14/1.4)	2 (50)	Dry		Brass	Bottom	Yes	Suitable for use with Air and Oil
112564	0-1500 (100/10)	2.5 (63)	Liquid	SST	SST	Bottom	Yes	Provides better resolution at lower pressures
17L706	0-3000 (210/-)	2.5 (63)	Liquid	SST	SST	Bottom	Yes	Tee into G3 or G-Mini outlet.
2007096	0-5000 (350/35)	2.5 (63)	Liquid	SST	Bronze	Bottom	Yes	Included with Lube Master (LMxxxx) packages. Tee into G3 or G-Mini outlet.
551387	0-10,000(690/69)	2.5 (63)	Liquid	SST	SST	Bottom	Yes	
112567	0-1500 (100/10)	2.5 (63)	Liquid	SST	Brass	Center-Back	Yes	Option for G3 vent valves on oil systems
557278	0-1500 (100/-)	2 (50)	Dry		Brass	Center-Back	No	Included with Miniature Meter-Flo (MMxxxx) packages
557864	0-3000 (210/-)	2.44 (62)	Dry		Bronze	Center-Back	No	Included with most Modu-Flo baseplate manifold kits, and many other Trabon pump packages
557866	0-3000 (210/-)	2.5 (63)	Liquid	SST	Brass	Center-Back	No	Installed option on some MVB packages
113641	0-3000 (200/20)	2.5 (63)	Liquid	SST	SST	Center-Back	Yes	Option for G3 vent valves on grease systems
115523	0-5000 (350/35)	2.5 (63)	Liquid	SST	Brass	Center-Back	Yes	Option for G3 vent valves on grease systems
113654	0-5000 (350/35)	2.5 (63)	Liquid	SST	SST	Center-Back	Yes	Option for G3 vent valves on grease systems
558298	0-10,000(690/-)	2.5 (63)	Liquid	SST	SST	Center-Back	No	Installed option on some MVB packages

### G-Series Gauge Kits

- For use with series progressive divider valve or pump-to-point systems.

Part Number	Description
25U706	G-Series Gauge and Relief Valve Adapter Kit – includes 5,000 psi/350 bar gauge (2007096), street cross fitting (133643) and 1/4 NPT x NPSM swivel fitting (156823). Allows connection of gauge, relief valve and outlet fitting to pump outlet. NPSM swivel fitting installs in the G-Series pump outlet for easy clocking of the complete assembly. Relief valve sold separately – choose from one of the options on page 22.
2008155	G-Series Gauge and Return-to-Reservoir Adjustable Pressure Relieve Valve Kit – includes all of the parts in kit 25U706, plus adjustable PRV with elbows and tubing to plumb back to the reservoir of a G3 or G-Mini pump.



25U706

## Ordering Information

### Mounting Weld Studs

Part Number	Thread	Thread Length
127512	1/4 in-20	0.71 in (18.0 mm)
127513	1/4 in-20	0.96 in (24.4 mm)
127514	1/4 in-20	1.2 in (30.5 mm)
17D024	1/4 in-20	2 in (50.8 mm)
17D023	3/8 in-16	1.25 in (30.5)



127512

### Mounting Weld Stud Fixture

Part Number	Description
17J423	MSP/MHH Weld Stud Fixture – attach studs to the jig before welding to ensure perfect alignment. For 3-valve to 8-valve assemblies

### P-Clamps

Part Number	Clamp ID inches (mm)	Mounting Hole
128006	0.38 (9.5)	0.40 in (10.3 mm)
127012	0.38 (9.5)	0.28 in (7.1 mm)
557944	0.50 (12.7)	0.28 in (7.1 mm)
127515	1.50 (38.1)	0.28 in (7.1 mm)



128006

### Fill Studs for Grease Reservoirs

Part Number	Description
24M644	1/4 QD style with cap, 1/4 in NPT male thread – accessory for G3 and G-Mini pumps
557874	1/4 QD style, 1/4 in NPT male thread
557880	1/4 QD style, 3/8 in NPT male thread – replacement part for Grease Jockey (pneumatic), LubePro and CDS pumps
557875	Cap for 1/4 QD, black PVC with retaining loop
100854	"Giant" Button Head, 1/4 in NPT male thread
557374	Trabon-style Fill Stud
557373	Cap for Trabon-style Fill Stud



24M644

### Mating Couplers

Part Number	Description
121474	1/4 in QD x 1/4 in NPT female coupler. Mates to 1/4 QD fill studs above.
200021	Giant Button Head coupler, 1/8 NPT female
558906	Mates to Trabon-style Fill Stud 557374



121474

# Installation Accessories – Other Fittings and Accessories

## Ordering Information

### Grease Nipples (Zerks)

Part Number	Description
557969	Grease Zerk Cover
555888	1/8 in NPT, 5,000 PSI, straight, leakproof
556429	1/8 in NPTF, 5,000 PSI, 90°, leakproof, Buna-N
100054	1/8 in NPTF, 10,000 PSI, straight with check ball
557968	1/8 in NPT, 65°
100848	1/4 in NPT, 10,000 psi, 67° with check ball
130883	M5, 10,000 PSI, straight with check ball
15M037	Press-to-Fit – 1/8 in NPSF female fitting – use to replace drive-type Zerks



557969



555888

### Grease Nipple Adapters (Zerk Adapters)

- Use with drive type or metric threaded grease nipples if re-tapping is not possible.

Part Number	Description
556448	Straight, wrench-on, 1/8 in NPT female – after being placed on a Zerk and a mating fitting is installed, adapter cannot be removed from the grease nipple.
563776	90°, press-on, includes 3/16 inch compression fitting



556448

### Cable Ties

Part Number	Description
563770	Standard duty, black nylon, 11.5 in length, 100 pack
17K063	Heavy duty, black nylon, UV Resistant, 14 in length x 0.30 in width, 100 pack

### Vice Block Tool

Part Number	Description
127145	For use with 1/8 in, 1/4 in, 3/8 in and 1/2 in ID hose



127145

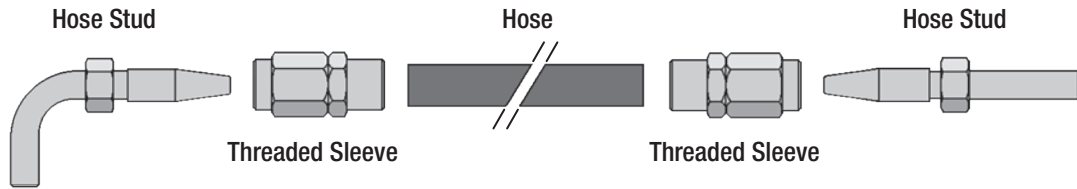

## Ordering Information

### 8.6 mm OD Hoses and Accessories

#### 8.6 mm OD Hose

- Polyamid inner
- Braided synthetic fiber reinforcement
- Anti-abrasion polyurethane cover, stabilized to UV rays
- 5/32 in (4 mm) ID
- Maximum working pressure 4,000 psi (276 bar)
- Working temperature range: -40°F to 212°F (-40°C to 100°C)

	Part Number	Length ft (m)
	<b>Non-Filled</b>	
	17S552	82 (25)
	17S553	164 (50)
	17S554	328 (100)
	17S555	656 (200)
<b>Filled with NLGI #2 Grease</b>		
	133281	32.8 (10)
	133282	98.4 (30)
	130938	164 (50)



#### Spiral Wrap Hose Guard

- Nylon
- 9 mm ID
- Working temperature range: -40°F to 212°F (-40°C to 100°C)

	Part Number	Length ft (m)
		123147

#### 6 mm OD Hose Studs

- For use with compression fittings
- Field-installable hose end fittings for use with 8.6 mm OD hose
- Maximum working pressure 3,000 psi (207 bar)

	Part Number	Description
	17R565	Straight hose stud
	17R566	90° elbow hose stud
	17L648	Threaded sleeve



# Installation Accessories – Hoses, Tubing and Fittings

## Ordering Information

### 8.6 mm OD Hoses and Accessories (Cont.)















#### 6 mm OD G-Lock hose studs

- For use with 6 mm G-Lock push-to-connect fittings
- Field-installable hose end fittings for use with 8.6 mm OD hose
- Maximum working pressure 2,000 psi (138 bar)

	Part Number	Description
	17L649	Straight hose stud
	17L650	90° elbow hose stud
	17L648	Threaded sleeve

#### 6 mm compression fittings

- Mate to 6 mm OD hose studs 17R565 and 17R566
- Can also be used with 6 mm OD steel tubing
- Not for use with nylon or other plastic tubing
- Maximum working pressure 3,000 psi (207 bar)





	Part Number	Description
	17L550	CSP outlet fitting with check valve
	17T780	1/8 NPT male straight
	17T781	1/8 NPT male elbow 90°
	17T782	1/4 NPT male straight
	17T783	1/4 NPT male elbow 90°
	17L548	1/8 BSPT male straight
	17L546	1/8 BSPT male elbow 90°
	17R571	1/4 BSPT male straight
	17R572	1/4 BSPT male 90°
	17R573	M6 tapered male straight
	17R574	M6 tapered male elbow 90°
	17R575	M8 tapered male straight
	17R576	M8 tapered male elbow 90°
	17R577	M10 tapered male straight
	17R578	M10 tapered male elbow 90°

## Ordering Information

### 8.6 mm OD Hoses and Accessories (Cont.)



#### 6mm G-Lock Fittings

- Mate to 6 mm OD G-Lock hose studs 17L649 and 17L680
- Push-to-connect for quick and easy installation
- Not for use with tubing
- Maximum working pressure 2,000 psi (138 bar)

	Part Number	Description
	17L545	1/8 BSPT male straight
	17L449	1/8 BSPT male elbow 90°
	17R569	1/4 BSPT male straight
<i>Image Coming Soon</i>	17R570	1/4 BSPT male elbow 90°
	17Y689	1/8 NPT male straight
<i>Image Coming Soon</i>	17L458	CSP outlet fitting with check valve

#### Threaded Fittings

- Field-installable hose end fittings for use with 8.6 mm OD hose
- With swivel, for ease of installation
- Maximum working pressure 3,000 psi (207 bar)

	Part Number	Description
	17Y690	JIC-4 female, with sleeve
	17Y691	1/8-27 NPT male, with sleeve

# Installation Accessories – Hoses, Tubing and Fittings

## Ordering Information

### 1/8 in ID Hoses and Accessories

#### 1/8 in ID Hose

- Thermoplastic hose
- Braided with polyurethane cover
- 0.327 in (8.3 mm) OD
- Maximum working pressure 3,000 psi (207 ba)
- Maximum temperature 212°F (100°C)

	Part Number	Length ft (m)
	128679	82 (25)
	128572	100 (30)
	128573	125 (38)
	128570	200 (61)
	128571	400 (122)
	128862	2000 (610)



#### Spiral Wrap Hose Guard

- Nylon
- 3/8 in (9.5 mm) ID
- 0.055 in (1.4 mm) wall thickness
- Working temperature range: -40°F to 212°F (-40°C to 100°C)

	Part Number	Length ft (m)
	128579	160 (49)
	2006075	200 (60)
	128580	325 (99)

#### Threaded Fittings

- Field-installable hose end fittings for use with 1/8 in ID hose
- With swivel, for ease of installation
- Maximum working pressure 3,000 psi (207 bar)





	Part Number	Description
	128561	JIC-4 female, with sleeve
	128562	1/8-27 NPT male, with sleeve
	133090	1/8-27 NPT male, with sleeve, Stainless Steel

## Ordering Information

### 1/8 in ID Hoses and Accessories (Cont.)



#### 1/4 in OD G-Lock Hose Studs

- For use with 1/4 in diameter G-Lock push-to-connect fittings
- Field-installable hose end fittings for use with 1/8 in ID hose
- Maximum working pressure 3,000 psi (207 bar)



	Part Number	Description
	25M496	90° elbow hose stud, with sleeve
	17L437	90° elbow hose stud, bare (without sleeve)
	25M497	Straight hose stud, with sleeve
	17L438	Straight hose stud, bare (without sleeve)
	17L647	Threaded sleeve

#### 1/4 in diameter G-Lock Fittings

- Mate to 1/4 in OD G-Lock hose studs (above)
- Push-to-connect for quick and easy installation
- Not for use with tubing
- Maximum working pressure 2,000 psi (138 bar)

	Part Number	Description
	17L442	1/8 NPT male straight
	17L547	1/4 NPT male straight
	17L441	CSP outlet fitting with check valve

#### 1/8 in ID Hose Accessories

	Part Number	Description
	128006	P-Clamp
	17L941	Hose Repair Kit – includes qty 4 of fitting 128561 and two JIC-4 nipples.

# Installation Accessories – Hoses, Tubing and Fittings

## Ordering Information

### 1/4 in ID Hoses and Accessories

#### 1/4 in ID Hose

- Thermoplastic hose
- Braided with polyurethane cover
- 0.476 in (12.1 mm) OD
- Maximum working pressure 2,750 psi (207 bar)
- Maximum temperature 212°F (100°C)

	Part Number	Length ft (m)
	128682	60 (18)
	128680	80 (24)
	128572	100 (30)
	128573	125 (38)
	130281	250 (76)
	131164	500 (152)



#### Spiral Wrap Hose Guard

- Nylon
- 1/2 in (12.7 mm) ID
- 0.051 inch (1.3 mm) wall thickness
- Working temperature range: -40°F to 212°F (-40°C to 100°C)



	Part Number	Length ft (m)
	128581	80 (24)
128582	100 (30)	

#### Threaded Fittings

- Field-installable hose end fittings for use with 1/4 in ID hose
- With swivel, for ease of installation
- Maximum working pressure 3,000 psi (207 bar)

	Part Number	Description
	128563	JIC-4 female, with sleeve
	128565	1/8-27 NPT male, with sleeve
	128564	1/4-18 NPT male, with sleeve



### 1/4 in ID Hose Accessories

	Part Number	Description
	557944	P-Clamp, 9/32 in mounting hole
	17L942	Hose Repair Kit – includes qty 4 of fitting 128563 and two JIC-4 nipples.

## Ordering Information

### 3/8 in ID Hose

- Synthetic rubber inner
- Braided steel wire reinforcement
- Synthetic rubber cover
- 3/4 in (4 mm) OD,
- Maximum working pressure: 4,750 psi (330 bar),
- Working temperature range: -40°F to 212°F (-40°C to 100°C)

	Part Number	Description
	17P336	100 ft (30 m)
	17P337	Field-Installable Swivel Hose End Fitting, 3/8 in ID Hose, #6 JIC, SAE 9/16-18 female
	117832	Straight adapter fitting, JIC-6 male x 3/8 in NPT male

Refer to the "Steel Fittings" section for more JIC fitting options.

### 6mm OD Tubing and Accessories

#### 6mm OD Tubing

- Nylon
- 0.12 in (3 mm) ID
- Maximum working pressure: 1,000 psi (69 bar)
- Working temperature range: -40°F to 212°F (-40°C to 100°C)

	Part Number	Length ft (m)
	17S556	82 (25)
	17S557	164 (50)
	17S558	328 (100)
	17S559	656 (200)
	25N013	82 (25) – Filled with Lithium EP2 grease

# Installation Accessories – Hoses, Tubing and Fittings

## Ordering Information

### 6mm OD Tubing and Accessories (Cont.)



#### 6mm Push-to-Connect Fittings

- Push-to-connect for quick and easy installation
- For Nylon tubing only; not for use with metal tubing or hose studs
- Maximum working pressure: 1,000 psi (69 bar)

	Part Number	Description
	130966	1/8 NPT male straight
	17R567	1/8 BSPT male straight
	17L457	M6 tapered male straight
	17L456	M8 tapered male straight
	17L455	M10 tapered male straight
	130965	1/8 NPT male elbow 90°
	17R568	1/8 BSPT male elbow 90°
	17L448	M6 tapered male elbow 90°
	17L447	M8 tapered male elbow 90°
	17L446	M10 tapered male elbow 90°
	17L543	CSP outlet fitting with check, 800 psi (55 bar) maximum
<i>Image Coming Soon</i>	17V721	Straight union fitting

#### 6mm Compression Fittings

- Compression fit ensures a secure connection
- Suitable for use with 6 mm OD nylon or steel tubing
- Maximum working pressure: 3,000 psi (207 bar)



	Part Number	Description
	17T783	1/4 NPT male elbow 90°
	17R572	1/4 BSPT male elbow 90°

## Ordering Information



### 1/8 in OD Tubing and Accessories

#### 1/8 in OD Tubing

- Nylon
- 0.073 inch (1.85 mm) ID
- Maximum working pressure: 625 psi (43 bar)
- Working temperature range: -60°F to 200°F (-51°C to 93°C)

	Part Number	Description
	127554	Tube, 1/8 in OD, 625 psi, 100 ft (30 m)
	127551	1/8 NPT compression fitting

### 1/8 in Street Elbows – Zero Radius

	Part Number	Description
	15K783	90° Elbow – 1/8-27 PTF SAE short
	557395	45° Elbow – 1/8-27 NPT

### 3/16 in OD Tubing and Accessories

#### 3/16 in OD Tubing

- Grease Jockey Lube Point Tubing
- Also used with air/oil spray nozzle 562994
- Nylon
- 1/10 inch (2.54 mm) ID
- Maximum working pressure: 800 psi (55 bar)
- Working temperature range: -60°F to 200°F (-51°C to 93°C)

#### Single Non-Filled Tubes – Black

	Part Number	Length ft (m)
	561131	60 (18)
	16A169	100 (30)
	128268	500 (152)
	2008771	5,000 (1,524)

#### Single Filled (Charged) Tubes – Black

	Part Number	Length ft (m)
	564086	10 (3)
	563786	15 (4.6)
	15W165	30 (9)

# Installation Accessories – Hoses, Tubing and Fittings

## Ordering Information

### 3/16 in OD Tubing and Accessories (Cont.)

#### Single Filled (Charged) Tubes – Orange

- Filled (charged) with NLGI #00 grease

<i>Image Coming Soon</i>	Part Number	Length ft (m)
	563789	15 (4.6)

#### Double Tubes – One Black, One Orange with Black Cover

	Part Number	Length ft (m)
	16A171	100 (30)

#### Double Filled (Charged) Tubes – One Black, One Orange with Black Cover

- Filled (charged) with NLGI #00 grease

	Part Number	Length ft (m)
	563984	10 (3)
	563788	15 (4.6)
	564090	30 (9)

#### Triple Tubes – One Black, One Orange, One Blue with Black Cover

	Part Number	Length ft (m)
	16A172	100 (30)

#### Triple Filled (Charged) Tubes – One Black, One Orange, One Blue with Black Cover

- Filled (charged) with NLGI #00 grease







	Part Number	Length ft (m)
	563994	10 (3)
	563783	15 (4.6)
	563796	30 (9)

## Ordering Information

### 3/16 in OD Tubing and Accessories (Cont.)

#### Brass Compression Fittings for 3/16 in OD Nylon or Copper Tubing

- With captive ferrule for easy alignment

	Part Number	Description
	556644	Straight Connector, 1/8 in-27 NPT male
	562995	Straight Connector, 1/4 in-28 SAE tapered male
	556638	Elbow, 1/8 in-27 NPT male
	556647	Union Fitting
	556642	Straight Connector, 1/8 in-27 NPT female
	556660	Spare Nut, with captive ferrule
	563776	Zerk Adapter, elbow, wrench-on aluminum body with brass compression fitting

#### Push-to-Connect Fittings for 3/16 in OD Nylon Tubing

- Not for use with metal tubing or hose studs

	Part Number	Description
	556661	Straight Connector, 1/8 in-27 NPT male

# Installation Accessories – Hoses, Tubing and Fittings

## Ordering Information



### 1/4 in OD Tubing and Accessories

#### 1/4 in OD Tubing

- Nylon
- 0.150 inch (3.9 mm) ID
- Maximum working pressure: 625 psi (43 bar)
- Working temperature range: -60°F to 200°F (-51°C to 93°C)



	Part Number	Length ft (m)
	127555	100 (30)

#### Brass Compression Fittings for 1/4 in OD Nylon or Copper Tubing

	Part Number	Description
	127553	Straight Connector, 1/8 in-27 NPT male, with captive ferrule
	556634	Elbow, 1/8 in-27 NPTF male, 3-piece
	555726	Elbow, 1/4 in-18 NPTF male, 3-piece

#### Push-to-Connect Fittings for 1/4 in OD Nylon Tubing

- Not for use with metal tubing or hose studs

	Part Number	Description
	17L653	Straight Connector, 1/8 in-27 NPT male
	17L652	Elbow, 1/8 in-27 NPTF male
	17L440	CSP outlet fitting with check, p-t-c

#### Compression Fitting for 1/4 in OD Nylon Tubing

- For nylon tubing only; not for use with metal tubing or hose studs
- Carbon steel body and nut
- Brass compression ferrule and clamping ring
- Maximum working pressure 1,000 psi (69 bar)

	Part Number	Description
	17L692	CSP outlet fitting with check, compression

## Ordering Information

### 5/16 in OD Tubing and Accessories

#### 5/16 in OD Tubing

- Grease Jockey Mainline Tubing
- Nylon
- 0.191 in (4.85 mm) ID
- Maximum working pressure 375 psi (26 bar)
- Working temperature range: -40°F to 200°F (-40°C to 93°C)

	Part Number	Length ft (m)
	561134	30 (9)
	25T847	40 (12)
	561132	60 (18)
	561133	164 (50)

#### Brass Compression Fittings for 5/16 in OD Nylon or Copper Tubing

- With captive ferrule for easy alignment

	Part Number	Description
	556656	Tube Insert – required at each connection to support inside of tubing when compressed
	557963	20-pack of tube insert 556656
	556643	Straight Connector, 1/8 in-27 NPT female
	556645	Straight Connector, 1/8 in-27 NPT male
	556646	Straight Connector, 1/4 in-18 NPT male
	556639	Elbow, 1/8 in-27 NPTF male
	556640	Elbow, 1/4 in-18 NPTF male
	556636	Tee, 5/16 in tube female runs x 1/8 in-27 NPTF male branch
	556648	Union Fitting
	556637	Union Tee
	556666	Spare Nut, with captive ferrule

#### Bulkhead Coupling

- Brass
- 1/8 in NPTF female both ends
- Maximum working pressure 375 psi (26 bar)
- Male thread 5/8 in-18 (15.9 mm) diameter
- 1.5 in (38.1 mm) length
- Maximum surface thickness 0.89 in (22.6 mm)
- Maximum pressure 1000 psi (68 bar)

	Part Number	Description
	557950	1/8 in NPTF female





# MANZEL®

---

	Page
MBL Box Lubricators . . . . .	222-226
MB Specialty Box Lubricators . . . . .	227
GBL 7500 Pump . . . . .	228
Model HP-15™ High Pressure Lubricators . . . . .	229
Model HP-50™ High Pressure Lubricators . . . . .	230
MVB Pump. . . . .	231
MVB Box Lubricator Configurator. . . . .	232
Lube-Line Alert . . . . .	233
Pneumatic/Electric Lube Sentry Valve . . . . .	234
Balancing Valve . . . . .	235

## Features and Benefits

- Provide a proven, cost-effective way to assemble customized oil systems that meet specific requirements by using standard modular components
- Increase opportunities to standardize lube system components and reduce lube maintenance and service costs
- Dependable and backed by the industry's most comprehensive international distributor network—with application expertise, parts stocks, and factory-trained service nearby, wherever you are located



## Typical Fluids Handled

- Mineral oil base or synthetics

## Typical Applications

- Provide lubrication to cylinder walls, bearings and other moving parts of equipment such as refineries, injection and storage, general manufacturing, air systems, and food processing equipment

Application	Industry	Use
Compressors	Petrochemical, Refineries, Gas Transmission, Injection and Storage, Cold Storage, General Manufacturing, Air Systems	Lubricate cylinder walls and piston shaft packing
Edgers, Planers, Band Saws	Lumber	Lubricate slides and ways. Blade coolant.
Mixers	Rubber	Used in the bleeding process and to lubricate dust stop seals
Can Lid Presses	Food Processing	Lubricate high-speed bearings
Band Saws	Lumber	Saw guides

## Modularity

Force Feed Box Lubricators provide true modularity that permits customizing a pump-to-point lubrication system from off-shelf components. The modular variables consist of the following categories of components:

- Pumps
- Reservoir
- Reservoir Heaters
- Reservoir Oil Level Controls
- Drives
- Shaft Rotation Alarm
- Motor and Motor Mounting Bases

In addition to these Force Feed Box Lubricator components, Graco offers a complete line of auxiliary equipment. Also, MBL pumping packages can be used with divider valves in a series progressive installation. Graco's performance-proven products that may be used with Modular Box Lubricators are listed on the next page along with the respective literature number.

## Description

A basic pump-to-point system is shown in the illustration which depicts six pumps mounted on a common reservoir from which each pump is dispensing oil to a single lubrication point. These pumps are operated by individual cams on one common drive shaft.

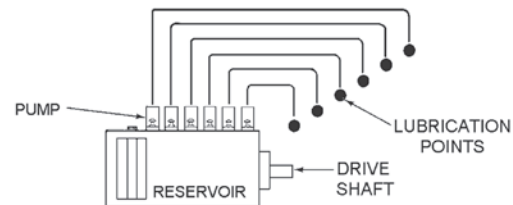

**Pump-to-Point System**

## Interchangeability, Conversion and Retrofits

Graco GBL 7500 Pumps have been designed to be easily interchangeable with other manufacturers' pumps. For details contact your local Graco representative or call on us for system design and application assistance.

## MBL Force Feed Box Lubricator = True Modularity

Wide choice of standard modular components helps you meet application requirements more exactly without the added costs of a custom system.

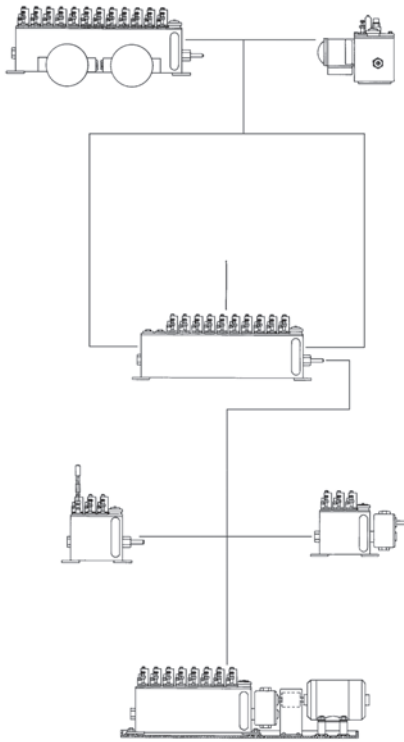

## Pumps

Graco GBL 7500 pumps for pressures up to 7,500 psi.

- 24J391 – GBL 7500 Suction Pump, 3/16 in
- 24J392 – GBL 7500 Suction Pump, 1/4 in
- 24J393 – GBL 7500 Suction Pump, 3/8 in

- Ideal for heavy duty applications
- Interchangeable with pumps from competitive lubricators
- Suction (vacuum feed) pumps are available installed
- Pressure feed and gravity feed pumps are sold separately
- See Instruction Manual 3A2257 for more information

## Alarm Pump

Shaft Rotation/Low Level alarm based on GBL 7500 pump.

- Available as part number 24K466.
- Mounts in a pump slot
- Order separately for field installation.

## Reservoirs and Mounting Bases

Eight reservoir capacities are available to hold from 4 to 40 pints and accommodate from 1 to 24 pumps. Blank cover assemblies included on unused pump stations. Eight sizes of motor mounting bases are available to accommodate the various reservoir sizes.

## Reservoir Accessories

Automatic fill, low level, and electric heater options.

## Drive Options

Over a dozen drive options are available from direct drive to a reduction ratio of 400:1. Options provide left- or right-hand end of reservoir mounting, end rotary drives, end ratchet drives and gear reducers. For details, see pages 224 and 225. See page 227 for MB60 (60:1) and MB118 (118:1) specialty box lubricators

## Motors

Single- and three-phase motors are available at ratings of 1/3, 1/4 and 1/2 HP, for 115/230 volt or 230/460 volt, in explosion-proof, TEFC or TENV configuration. Some motor configurations are available foot-mounted and/or face-mounted.

## “Smart” Part Numbers

- Graco part numbers are 6-digits long
- MBL Smart Part Numbers start with “MB”
- The next four letters each specify one or more options:
  - Option A: Reservoir and Motor Mounting Base
  - Option B: Pump Style and Monitor
  - Option C: Pump Quantity
  - Option D: Drive
- MBabcd – replace lower case letters with selections offered in **Smart Menu Code** to form a **Smart Part Number**

## Literature

L54000	Lube Line Alert
L15831	Lube Sentry
L15825	Check Valves
L15200	In-Line Filters
L10103	MH Modular Divider Valves
3A2100	Modular Box Lubricator (MBL) Instruction Manual
3A2257	GBL7500 pumps Instruction Manual
352389	Manzel MB60 & MB118 flyer
3A2953	Center Drive Box Lubricator Instruction Manual

# Manzel® MBL Pump/Reservoir Combinations

**NOTE:** LH option currently available only on MBL-G01, G02, G03, and G04 drives. All part numbers on the chart below use “OA” to indicate assemblies with NO pumps. Refer to Smart Code ordering details.

 = Not compatible

		Reservoirs Without Motor Mounting Bases								Reservoirs Combined With Motor Mounting Bases							
		T1	T2	T3	T4	T5	T6	T7	T8	T1 + P1	T2 + P2	T3 + P3	T4 + P4	T5 + P5	T6 + P6	T7 + P7	T8 + P8
		4 pint / 2 feed	6 pint / 3 feed	8 pint / 5 feed	12 pint / 8 feed	16 pint / 12 feed	24 pint / 16 feed	32 pint / 20 feed	40 pint / 24 feed	4 pint / 2 feed	6 pint / 3 feed	8 pint / 5 feed	12 pint / 8 feed	16 pint / 12 feed	24 pint / 16 feed	32 pint / 20 feed	40 pint / 24 feed
G01R	Direct, 1:1	MBA0AA	MBB0AA	MBC0AA	MBD0AA	MBE0AA	MBF0AA	MBG0AA	MBH0AA								
G02R	End Ratchet	MBA0AB	MBB0AB														
G03R	37.5:1 Ratchet	MBA0AC	MBB0AC														
G04R	75:1 Ratchet	MBA0AD	MBB0AD														
G01L	Direct, 1:1	MBA0AE	MBB0AE	MBC0AE	MBD0AE	MBE0AE	MBF0AE	MBG0AE	MBH0AE								
G02L	End Ratchet	MBA0AF	MBB0AF														
G03L	37.5:1 Ratchet	MBA0AG	MBB0AG														
G04L	75:1 Ratchet	MBA0AH	MBB0AH														
G05R	25:1 End Rotary	MBA0AJ	MBB0AJ	MBC0AJ	MBD0AJ	MBE0AJ				MBJOAJ	MBKOAJ	MBLOAJ	MBMOAJ	MBNOAJ			
G06R	50:1 End Rotary	MBA0AK	MBB0AK	MBC0AK	MBD0AK	MBE0AK				MBJOAK	MBKOAK	MBLOAK	MBMOAK	MBNOAK			
G07R	100:1 End Rotary	MBA0AL	MBB0AL	MBC0AL	MBD0AL	MBE0AL				MBJOAL	MBKOAL	MBLOAL	MBMOAL	MBNOAL			
G08R	200:1 End Rotary	MBA0AM	MBB0AM	MBC0AM	MBD0AM	MBE0AM				MBJOAM	MBKOAM	MBLOAM	MBMOAM	MBNOAM			
G09R	400:1 End Rotary	MBA0AN	MBB0AN	MBC0AN	MBD0AN	MBE0AN				MBJOAN	MBKOAN	MBLOAN	MBMOAN	MBNOAN			
G18R	400:1 Heavy Duty														MBPOAY	MBROAY	MBSOAY

## MBL Smart Code Ordering Menu

MB – X – X – X – X

### Reservoir (Smart Code Option A)

Code	Former Code(s)	Description	Code	Former Code(s)	Description
A	T1	4 pt, 2 pump stations max	J	T1 and P1	4 pt, 2 pump stations max, motor mount base
B	T2	6 pt, 3 pump stations max	K	T2 and P2	6 pt, 3 pump stations max, motor mount base
C	T3	8 pt, 5 pump stations max	L	T3 and P3	8 pt, 5 pump stations max, motor mount base
D	T4	12 pt, 8 pump stations max	M	T4 and P4	12 pt, 8 pump stations max, motor mount base
E	T5	16 pt, 12 pump stations max	N	T5 and P5	16 pt, 12 pump stations max, motor mount base
F	T6	24 pt, 16 pump stations max	P	T6 and P6	24 pt, 16 pump stations max, motor mount base*
G	T7	32 pt, 20 pump stations max	R	T7 and P7	32 pt, 20 pump stations max, motor mount base*
H	T8	40 pt, 24 pump stations max	S	T8 and P8	40 pt, 24 pump stations max, motor mount base*

\*Cannot use double reduction or right angle drives.

### Pump Size – GBL 7500 Suction Pumps (Smart Code Option B)

Code	Former Code(s)	Description
0	00	No pumps
1	76/88B	3/16 in Suction Pump 24J391
2	76/88C	1/4 in Suction Pump 24J392
3	76/88E	3/8 in Suction Pump 24J393
4	76/88B and F3	3/16 in Suction Pump plus RENS Level Controller
5	76/88C and F3	1/4 in Suction Pump plus RENS Level Controller
6	76/88E and F3	3/8 in Suction Pump plus RENS Level Controller
7	76/88B and F4	3/16 in Suction Pump plus GARZO Level Controller
8	76/88C and F4	1/4 in Suction Pump plus GARZO Level Controller
9	76/88E and F4	3/8 in Suction Pump plus GARZO Level Controller

#### NOTES:

1. When pump quantity is less than maximum pump stations of specified reservoir, a blank cover assembly is installed at Graco.
2. When low level is specified, deduct one pump for each option.
3. When ordering a ratchet drive, the maximum number of pumps allowable is 3.

### Pump Quantity (Smart Code Option C)

Code	Qty	Code	Qty	Code	Qty	Code	Qty	Code	Qty	Code	Qty
A	0	E	4	J	8	N	12	T	16	X	20
B	1	F	5	K	9	P	13	U	17	Y	21
C	2	G	6	L	10	R	14	V	18	Z	22
D	3	H	7	M	11	S	15	W	19		

### Drive Options (Smart Code Option D)

Code	Former Code	Description	Code	Former Code	Description
A	G01R	Direct End Rotary (50 rpm max)	J	G05R	Double Reduction End Rotary 25:1
B	G02R	End Ratchet (without drive arm 563005)	K	G06R	Double Reduction End Rotary 50:1
C	G03R	End Rotary Ratchet 37-1/2:1 – max input of 800 RPM	L	G07R	Double Reduction End Rotary 100:1
D	G04R	End Rotary Ratchet 75:1 – max input of 800 RPM	M	G08R	Double Reduction End Rotary 200:1
E	G01L	Direct End Rotary	N	G09R	Double Reduction End Rotary 400:1
F	G02L	End Ratchet (without drive arm 563005)	Y	G18R	400:1 Ratio Gear Reducer**
G	G03L	End Rotary Ratchet 37-1/2:1 – max input of 800 RPM			
H	G04L	End Rotary Ratchet 75:1 – max input of 800 RPM			

\*\*Drive requires motor mounting base; can only be used with reservoir options P, R, and S.

# Manzel® MBL Box Lubricator Accessories

## Ordering Information

Manzel® MBL Box Lubricator Motors	
558289	M2 – 1/4 hp, 1,725 rpm, 115/230V, 1 ph., TENV, Foot-Mounted (56F)
558293	M3 – 1/4 hp, 1,725 rpm, 115/230V, 1 ph., Hazardous Area, Class 1, Group D, Foot-Mounted (56F)
558290	M5 – 1/4 hp, 1,725 rpm, 230/460V, 3 ph., TENV, Foot-Mounted (56F)
558292	M6 – 1/4 hp, 1,725 rpm, 230/460V, 3 ph., Hazardous Area, Class 1, Group D, Foot-Mounted (56F)
558294	M7 – 1/2 hp, 1,725 rpm, 115/230V, 1 ph., Hazardous Area, Class 1, Group C, Severe Duty, Tropical Insulation, Face-Mounted or Foot-mounted (56C with feet)
558291	M10 – 1/2 hp, 1,725 rpm, 230/460V, 3 ph., 60Hz, Class 1, Group D, Face-Mounted (56C)
557271	M11 – 1/2 hp, 1,725 rpm, 115/230V, 1 ph., 60Hz, TEFC, Face-Mounted (56C)
557270	M12 – 1/2 hp, 1,725 rpm, 230/460V, 3 ph., 60Hz, TEFC, Face-Mounted (56C)

Note: Heavy Duty drive "Y" (G18R) requires 56C, face-mount. Normally a 1/2 hp motor would be used because more pumps are being operated by the HD drives.

Auto-Fill Options	
559037	F1 Gravity Supply

Note: F2 – obsolete, use F1 instead. F3 – ordered with pumps (see page 133). F4 – ordered with pumps (see page 133).

Low Level Switches	
563013	L1 – Low Level Switch Hazardous Area. Class 1, Group C and D; Class 2 Group, E, F and G.
564015	L2 – Low Level, 10 Watts at 120 VAC, SPST Reed Switch, NC

Shaft Rotation Arm	
24K466	GBL 7500 Suction Alarm Pump

Heater Options	
557207	120 VAC Electric Heater, Hazardous Area, Class 1, Group B, one-prong heater. Can be installed in 1 in NPT port on MBL reservoirs.
557208	240 VAC Electric Heater, Hazardous Area, Class 1, Group B, one-prong heater. Can be installed in 1 in NPT port on MBL reservoirs.

Note: Former codes H3, H4 and H6 use 557207. For H1, H2 and H5, contact factory for details about part number 564058 (two prong heater) Class 1, Group D

## Long Life and Durability

Leak-proof welded steel reservoir and solid steel, hardened cams. Double-supported cam shafts and gear drives to eliminate cantilevered assemblies and high load capacity needle bearings and ball bearings.

### MB118 Box Lubricators

- “Model 55” 118:1 reduction drive
- 4 or 6 pump stations max, use with any GBL 7500 pumps
- Maximum input speed 1,800 rpm
- Instruction Manual number 3A3006

### MB60 Box Lubricators

- Rear 60:1 reduction drive
- Perfect for bolt-on gas compressor box lubrication solutions
- 2 or 4 pump stations max, use with gravity-fed or pressure-fed GBL 7500 pumps
- Maximum input speed 1,800 rpm
- Instruction Manual numbers 3A2953, 334210



## Ordering Information

### MB118 Box Lubricators

#### 4 Pint (1.9 L), 4 Pump Capacity

For triplex mud pumps

Drive End		GBL 7500 Pumps*		Maximum Output Pressure
Left Hand	Right Hand	Quantity	Size	
25R513	24W633	0	N/A	N/A
25R557	24W636	3	1/4 in	6,000 psi (414 bar)

#### 6 Pint (2.8 L), 6 Pump Capacity

For quintuplex mud pumps

Right Hand Drive End	GBL 7500 Pumps*		Maximum Output Pressure
	Quantity	Size	
24W634	0	N/A	N/A
24W635	5	1/4 in	6,000 psi (414 bar)

### MB60 Box Lubricators

#### 2 Pint (0.95 L), 2 Pump Capacity

Left Rear Drive

Mount Orientation		GBL 7500 Pumps*	
Floor	Wall	Quantity	Size
24V068	25A071	0	N/A

#### 6 Pint (2.8 L), 4 Pump Capacity

Center Rear Drive

Drive Shaft		GBL 7500 Pumps*	
Keyway	Tang	Quantity	Size
24U750	24N724	0	N/A

\*See page 228 for GBL 7500 part numbers and more tech specs, including metric conversions.

# Manzel® GBL 7500 Pump

## Features and Benefits

Each GBL 7500 single-piston pump is mechanically driven from a camshaft in the reservoir. They are adjustable from 1 to 27 drops per stroke and develop pressures up to 7500 psi (517 bar), depending on the piston size. All working parts are totally enclosed away from dirt, water, and impurities and are self-lubricated at all times by the fluid in the reservoir. Rugged construction for high performance and durability with easy to adjust pump output.

## Typical Applications

- Compressors

## Typical Fluids Handled

- Mineral or synthetics oil

## Technical Specifications

Piston Size		Max Outlet Pressure			Drops/Stroke		Cubic Inch/Stroke		Cubic cm/Stroke		Strokes/minute	
inches	mm	PSI	MPa	bar	Min.	Max.	Min.	Max.	Min.	Max.	Min.	Max.
3/16	4.8	7500	51.7	517	0	7	0	0.014	0	0.229	3	50
1/4	6.4	6000	41.4	414	0	12	0	0.024	0	0.393	3	50
3/8	9.5	3500	24.1	241	0	27	0	0.054	0	0.885	3	50

## Ordering Information

GBL 7500	
24J391	3/16 in (4.8 mm) suction
24J392	1/4 in (6.4 mm) suction
24J393	3/8 in (9.5 mm) suction
24J394	3/16 in (4.8 mm) gravity
24J395	1/4 in (6.4 mm) gravity
24J396	3/8 in (9.5 mm) gravity
24J397	3/16 in (4.8 mm) pressure
24J398	1/4 in (6.4 mm) pressure
24J399	3/8 in (9.5 mm) pressure
24K466	Suction alarm pump
GBL Accessories and Spare Parts	
564332	Outlet Check Valve Assembly – maintains prime when changing out pumps
126070	Replacement Pump Gasket – used by all pumps
24T306	Sight Glass Replacement Kit – for use with suction, gravity and alarm pumps
563101	Replacement Suction Strainer – for use with suction and alarm pumps



## Features and Benefits

The high pressure lubricator comprises one to six integral sight and pump assemblies in a cast iron reservoir. The unit is designed for direct connection to an electric motor/speed reducer power source. A Manzel® terminal check valve is recommended in the lubrication system. When required to maintain proper oil viscosity, the reservoir can be fitted with an electric heater.

## Typical Applications

- Multi-stage gas compression

## Typical Fluids Handled

- Mineral or synthetic oil

## Technical Specifications

Number of Feeds	Max. Pressure	Reservoir Capacity (Quarts) (1)	Plunger Diameter (inches)	Drops Per Stroke		Cubic Inches Per Stroke		Cubic cm Per Stroke		Strokes Per Minute	
				Min.	Max.	Min.	Max.	Min.	Max.	Min.	Max.
1-6	18,000	7	1/4	1	4	0.002	0.008	0.033	0.113	3	36

## Ordering Information

562918	HP-15 6 feed gear box without pumps
562919	HP-15 6 feed gear box with 6 HP-15 pumps
562951	HP-15 pump
564151	HP-15 sight glass kit – includes sight “glass” made of polyamide, o-ring and rubber plug
563113	HP-15 plunger and cylinder assembly
564336	Check valve – 3/8 in OD tube compression fittings on both ends. Use in line or as the lubrication point.



562951

# Manzel® HP-50™ High Pressure Lubricator

## Features and Benefits

- Operating pressures to 60,000 psi for lubricating compressor and circulator cylinder walls, heavily loaded bearings and other moving parts
- Single plunger force feed design is highly efficient for injecting lubricants and/or compatible fluids into high pressure systems
- Vacuum sight feeds on self-contained pumping units show output of lubricant to individual lubrication points
- All working parts are totally enclosed and self-lubricated
- Individual pumping units easily removed for service
- Feed rate infinitely variable from minimum to maximum with simple hand adjustment

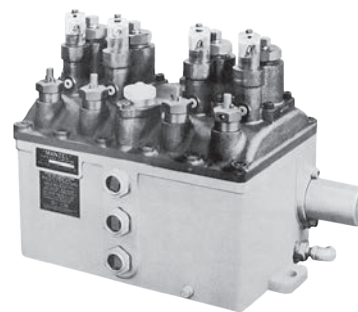

## Typical Applications

- Compressors and industrial equipment

## Typical Fluids Handled

- Mineral or synthetic oil

## Technical Specifications

Number of Feeds	Max. Pressure	Reservoir Capacity (Quarts) (1)	Plunger Diameter (Inches)	Drops Per Stroke		Cubic Inches Per Stroke		Cubic cm Per Stroke		Strokes Per Minute	
				Min.	Max.	Min.	Max.	Min.	Max.	Min.	Max.
1-4	60,000	9	1/4	1	4	0.002	0.008	0.033	0.113	3	36

## Ordering Information

HP-50 Pump	
562952	HP-50 Pump Assembly
HP-50 Lubricator Boxes	
564276	HP-50 Lubricator without Pumps or Options
562925	HP-50 Lubricator with 4 Pumps
562926	HP-50 Lubricator with 2 Pumps
562927	HP-50 Lubricator with 4 Pumps, Provision for Flange Mounted Auto Fill, and Nitrogen Purge Port
562928	HP-50 Lubricator with 4 Pumps, Low Level and Shaft Rotation Alarm
562929	HP-50 Lubricator with 4 Pumps, Provisions for Flange Mounted Auto Fill and Low Level in Fill Plate
564277	HP-50 Lubricator with 4 Pumps and Steam Heater
564278	HP-50 Lubricator with 3 Pumps and Steam Heater
564279	HP-50 Lubricator with 4 Pumps, Provision for Flange Mounted Auto Fill, Nitrogen Purge and Shaft Rotation/Low Level Alarm on Left
564280	HP-50 Lubricator with 4 Pumps, Provision for Flange Mounted Auto Fill, Nitrogen Purge and Shaft Rotation/Low Level Alarm on Right

564282	HP-50 Lubricator with 4 Pumps, Shaft Rotation and Low Level Alarm
564283	HP-50 Lubricator with 4 Lubricator Boxes with 15 Pumps, Provision for Center Mounted Motor and Base
258262	HP-50 Lubricator with 4 Pumps and Low Level
258263	HP-50 Lubricator with 4 Pumps, Provisions for Flange Mounted Auto Fill and Low Level in Fill Plate, and Proximity Switch Shaft Rotation Indicator on Right
HP-50 Accessories	
563111	HP-50 plunger and cylinder
564336	HP-50 check valve
558881	Electric heater, 120/240 VAC
563020	Shaft rotation alarm
563024	Low level
556808	Ren Oil Level Controller/Auto-fill, 5 psi maximum
558221	Garzo Oil Level Controller/Auto-fill, 70 psi maximum, Class 1, Groups C and D, Division I

### Features and Benefits

The MVB lubrication system is a single line, series progressive system which divides pump output into predetermined proportional amounts and distributes these amounts to points of lubrication.

- One main supply from single pump
- Central monitoring of normal operation
- Automatic proportioning of lubricant through positive displacement valves
- Quick indication of problem areas

### Typical Applications

- Compressors and reciprocating engines

### Typical Fluids Handled

- Oil

### Technical Specifications

Output per Pump in Pints (Liters) per Day

Single Camshaft rpm (pump strokes per min)	1/4 piston				3/8 piston			
	Min. Output Adj.		Max. Output Adj.		Min. Output Adj.		Max. Output Adj.	
	0.12456*(constant)		0.59832		0.29909*(constant)		1.4902	
20	2.49	(1.18)	11.97	(5.66)	5.98	(2.83)	29.92	(14.15)
30	3.74	(1.77)	17.95	(8.49)	8.97	(4.24)	44.88	(21.23)
40	4.98	(2.36)	23.93	(11.32)	11.96	(5.66)	59.84	(28.30)
50	6.23	(2.95)	29.92	(14.15)	14.95	(7.07)	74.80	(35.38)
60	7.47	(3.53)	35.90	(16.98)	17.95	(8.49)	89.76	(42.46)
70	8.72	(4.12)	41.88	(19.81)	20.94	(9.90)	104.72	(49.53)

\*Constant X strokes per minute = output in pints per day. For 2 and 3 lobe cams, multiply camshaft RPM times 2 or 3.

### Ordering Information

563565	MVB 0.250 in (6.35 mm) Piston Pump
563566	MVB 0.375 in (9.53 mm) Piston Pump
563920	Seal kit for MVB pump
563919	3/8 in piston and sleeve replacement
563918	1/4 in piston and sleeve replacement
557824	25 micron filter replacement element
557827	10 micron filter replacement element



563565



MVB Box lubricator

Compressor Lubrication

# Manzel® MVB Box Lubricator Configurator

## Ordering Menu Code

MV – X – X – X – X

### Drive

**Code (Former Code) – Description**

A	(DAA) Ratchet Drive (102-2)
B	(DAB) Standard Drive (203-2)
C	(DAC) Standard Drive (207-2)
D	(DAD) Reverse Drive (303-2)
E	(DAE) 90-Degree Drive (401-2)
F	(DAF) Vertical Drive (501-2)
G	(N/A) Tandem Drive

### Gear Box Ratio and Mounting Base Option

**Code (Former Code) – Description**

A	(RAA) 1:1 Ratio Gear Box
D	(RAB) 1:2 Ratio Gear Box
E	(RAC) 2:1 Ratio Gear Box
H	(RAD) 1:3 Ratio Gear Box

**Code (Former Code) – Description**

J	(RAE) 3:1 Ratio Gear Box
M	(RAF) 1:4 Ratio Gear Box
N	(RAG) 4:1 Ratio Gear Box
S	(RAH) 1:8 Ratio Gear Box

**Code (Former Code) – Description**

T	(RAJ) 8:1 Ratio Gear Box
U	(RAJ-KOA) 8:1 Ratio Gear Box with a KOA Base
W	(RAK) 16:1 Ratio Gear Box
X	(RAK-KOA) 16:1 Ratio Gear Box with a KOA Base

### Pump Station One Configuration\*

Code	Cam Style	Pump Size	Gauge PSI	Relief PSI	Code	Cam Style	Pump Size	Gauge PSI	Relief PSI
A	Single Lobe	No Pump	None	None	K	Double Lobe	1/4 in	10,000	4,600
B	Single Lobe	1/4 in	None	6,400	L	Double Lobe	3/8 IN	None	1,750
C	Single Lobe	1/4 in	3,000	2,350	M	Double Lobe	3/8 IN	3,000	1,750
D	Single Lobe	1/4 in	10,000	6,400	N	Triple Lobe	No Pump	None	None
E	Single Lobe	3/8 in	None	2,350	P	Triple Lobe	1/4 in	None	3,700
F	Single Lobe	3/8 IN	3,000	2,350	R	Triple Lobe	1/4 in	3,000	2,350
G	Double Lobe	No Pump	None	None	S	Triple Lobe	1/4 in	10,000	3,700
H	Double Lobe	1/4 in	None	4,600	T	Triple Lobe	3/8 IN	None	1,450
J	Double Lobe	1/4 in	3,000	2,350	U	Triple Lobe	3/8 IN	3,000	1,450

\*Former codes AOA and AOC referred to 1/4 in pump. Former codes AOB and AOD referred to 3/8 in pump. Former code POA referred to standard (2,350 psi) blowout indicator. Former codes GOA, GOB, GOC, and GOD referred to gauge options; choose from standard gauge options shown above.

### Pump Station Two Configuration\*\*

Code	Cam Style	Pump Size	Gauge PSI	Relief PSI	Code	Cam Style	Pump Size	Gauge PSI	Relief PSI
A	Single Lobe	No Pump	None	None	K	Double Lobe	1/4 in	10,000	4,600
B	Single Lobe	1/4 in	None	6,400	L	Double Lobe	3/8 IN	None	1,750
C	Single Lobe	1/4 in	3,000	2,350	M	Double Lobe	3/8 IN	3,000	1,750
D	Single Lobe	1/4 in	10,000	6,400	N	Triple Lobe	No Pump	None	None
E	Single Lobe	3/8 in	None	2,350	P	Triple Lobe	1/4 in	None	3,700
F	Single Lobe	3/8 IN	3,000	2,350	R	Triple Lobe	1/4 in	3,000	2,350
G	Double Lobe	No Pump	None	None	S	Triple Lobe	1/4 in	10,000	3,700
H	Double Lobe	1/4 in	None	4,600	T	Triple Lobe	3/8 IN	None	1,450
J	Double Lobe	1/4 in	3,000	2,350	U	Triple Lobe	3/8 IN	3,000	1,450

\*\*Former codes BOA and BOC referred to 1/4 in pump. Former codes BOB and BOD referred to 3/8 in pump. Former code HOA referred to standard (2,350 psi) blowout indicator. Former codes JOA, JOB, JOC, and JOD referred to gauge options; choose from standard gauge options shown above.

**NOTE: Motors for KOA base with 8:1 or 16:1 drives:**

- 558289 (MOA) - 1/4 HP, 115/230 VAC, 60 Hz, single-phase, 1,725 rpm, TENV, 56F
- 558290 (MOB) - 1/4 HP, 230/460 VAC, 60 Hz, three-phase, 1,725 rpm, TENV, 56F

Pump Station One is located on the left side, above the sight glass, for all MVB configurations.

## Features and Benefits

- Indicates Flow or No-Flow at any point in the system ahead of the Lube-Line Alert inlet. Not affected by discharge pressure.
- Operates under continuous or intermittent low-flow rates
- Universal use – operates in any air free force feed lubrication system—any make lubricator
- Sensitive to a wide range of flow from .006 cubic inches to 190 cubic inches per minute
- Many type lubricants and viscosities—mineral or synthetic
- Time delay adjustment to compensate for viscosity and/or flow rate. Quick and easy to adjust.
- Explosion-proof – UL and CSA Listed for Class I Groups C and D and Class II Groups E, F and G. Division 1 and 2 when installed as per NEC 501.
- For connection to any electrical warning system—lights, sound devices, machinery shut-off relays, telephones, etc.
- A low-level and shaft rotation



563030

## Technical Specifications

UL and CSA Electrical Ratings.....	Single pole, Throw magnetically operated switch, 115 VAC, 60Hz, 10 watt, 28 VDC, 0.5 amp Resistive, 28 VDC, 0.5 amp Inductive
Maximum Switch Rating.....	350 VAC/VDC, 50 watt, 2 amp
Maximum Operating Pressure.....	10,000 psi
Minimum Pressure Drop Access Alert .....	150 psi
Flow Rate .....	0.006 in <sup>3</sup> to 190 in <sup>3</sup> /min @ 100 SUS 0.006 in <sup>3</sup> to 75 in <sup>3</sup> /min @ 2,000 SUS
Fluid Viscosity.....	100 to 9,000 SUS
Weight .....	0.6 lbs

## Ordering Information

Lube-Line Alert	
563030	N.C. Configuration w/Check Valves for 1/4 in O.D. Tube
563032	N.O. Configuration w/Check Valves and Fittings for 1/8 in NPTF Connections
Inlet Check Valves	
563042	with 1/4 in O.D. Tube Fitting (supplied with 563030)
563041	with 7/16-20 Straight Female Thread (supplied with 563032)
Outlet Check Valves	
563044	with 1/4 in O.D. Tube Fitting (supplied with 563030)
563043	with 7/16-20 Straight Female Thread (supplied with 563032)
Fittings	
556624	7/16-20 Straight Male Thread x 1/8 in NPTF (2 supplied with 563032)
Springs	
556944	Standard Springs (installed at factory)
556939	Light Spring for Low Flow Applicator*
Repair Parts	
556812	Switch Assembly

\*When using the Light Spring 556939, fluid viscosity should not exceed 350 SUS.

# Pneumatic/Electric Lube Sentry Valve

## Features and Benefits

The Lube Sentry Valve provides automatic warning and shutdown of compressors, pumps and engines when oil is not flowing properly to primary dividers in series type lube systems.

- Absence of check valves to avoid trapping contamination from included solids in the lubricant
- Bolted-together components simplifying maintenance. The microswitch assembly on the pneumatic valve can be removed without disturbing existing lines or shutting down the equipment being lubricated.

## Technical Specifications

Material.....	Steel
Max Pressure .....	6,000 psi (414 bar)
Flow Rate (per day) .....	4 to 400 pints (1.89 to 189.2 liters)
Pressure Drop.....	250 psi (17 bar)
Seals.....	Fluoroelastomer
Lubricant.....	Oil (450-2,000 SUS)
Net Weight .....	0.5 lb (2.265 kg)
Operating Temperature .....	-20°F to 180°F (-29°C to 82°C)
Air Pressure (Max Pneumatic Valve) .....	125 psi (9 bar)
Electrical Rating .....	5 amps @ 125/250 VAC
	A,B or C @ 28 VDC, A- Inductive - 3 amp, B- Resistive - 5 amp, C- Max Inrush - 15 amp

## Ordering Information

563506	Pneumatic Lube Sentry, Complete
563503	Pneumatic Valve
563502	Actuator
563505	Electric Lube Sentry, Complete
563504	Switch Assembly



## Features and Benefits

The Graco® Balancing Valve assists divider valves to accurately proportion lubricant at high differential pressures. It is recommended for use when a pressure difference greater than 1,000 PSI exists between two or more of the points in a Graco divider valve system.

- Balancing valve is not affected by downstream pressure, assures accurate flow to all lubrication points
- Balancing valve is field adjustable. Reduces on-site inventory costs as one model meets all your system needs.
- Balancing valve is in-line mounted, so it lowers installation costs
- Balancing valve uses a wear-resistant tungsten-carbide ball to reduce maintenance costs



## Technical Specifications

Material.....	Steel
Max Operating Pressure.....	6,500 psi
Adjustable.....	From 1,000 to 6,500 psi (Factory set at 3,000 psi)
Operating Temperature.....	-10°F to 250°F (-23°C to 121°C)
Lubricant.....	Oil
Seals.....	Fluoroelastomer
Net Weight.....	1.19 lb (0.54 kg)

## Ordering Information

563230	Balancing Valve
563911	Valve Seal Kit



# ON-ROAD LUBRICATION



	Page
Electric Grease Jockey® . . . . .	237-239
Electric Grease Jockey Manifolds . . . . .	240
Electric Grease Jockey Injectors . . . . .	241
Electric Grease Jockey Accessories . . . . .	242-245
Pneumatic Grease Jockey . . . . .	246-248

## Electric Grease Jockey

The Grease Jockey system increases fleet utilization. It extends component life up to four times because automatic lubrication continuously flushes contaminants and reduces friction. Auto lube supports 50,000 mile service intervals, optimally lubricates when the vehicle needs it the most, and reduces operating costs. Service more vehicles in less time by utilizing modern automatic lubrication within your fleet.



### Ruggedized Construction

U.V., chemical, and high-impact resistant – rigorously tested and field-proven.

### NLGI #2 Compatible

NLGI #000 to #2 and 2,000 psi (138 bar).

### Low Level Signal

Alerts when out of grease.

### Electrical Drive

12 VDC (7 Amp) or 24 VDC (4 Amp) power. Protected against motor burn-out.

### Data Management System\*

Track critical lubrication data. Fast programming.

### Integrated Controls

Includes adjustable ON/OFF times, PIN code lockout and on-panel alerts.

### In-Cab Feedback\*

Tri-color LED system feedback indicator with Manual Run button.



\*DMS version optional equipment

### Technical Specifications

Maximum Pressure	2,000 psi (352 bar)
Power	12 VDC, 24 VDC
Operating Temperature	-40° F to 158° F (-40° C to 70° C)
Reservoir Size	2 liter
Maximum Run Time	30 minutes
Output per Element/Min	0.5 in <sup>3</sup> (8 cm <sup>3</sup> )
Certifications/Standards	IP69K, CE, ROHS, EMC, Pressurized Equipment Directive, National Fluid Power Association
Instruction Manual	3A5082

## How to Select Your Graco Electric Grease Jockey Automatic Lubrication System

Determining the Electric Grease Jockey system best suited to your needs is accomplished by following steps A-D.

On-Road Lubrication Systems

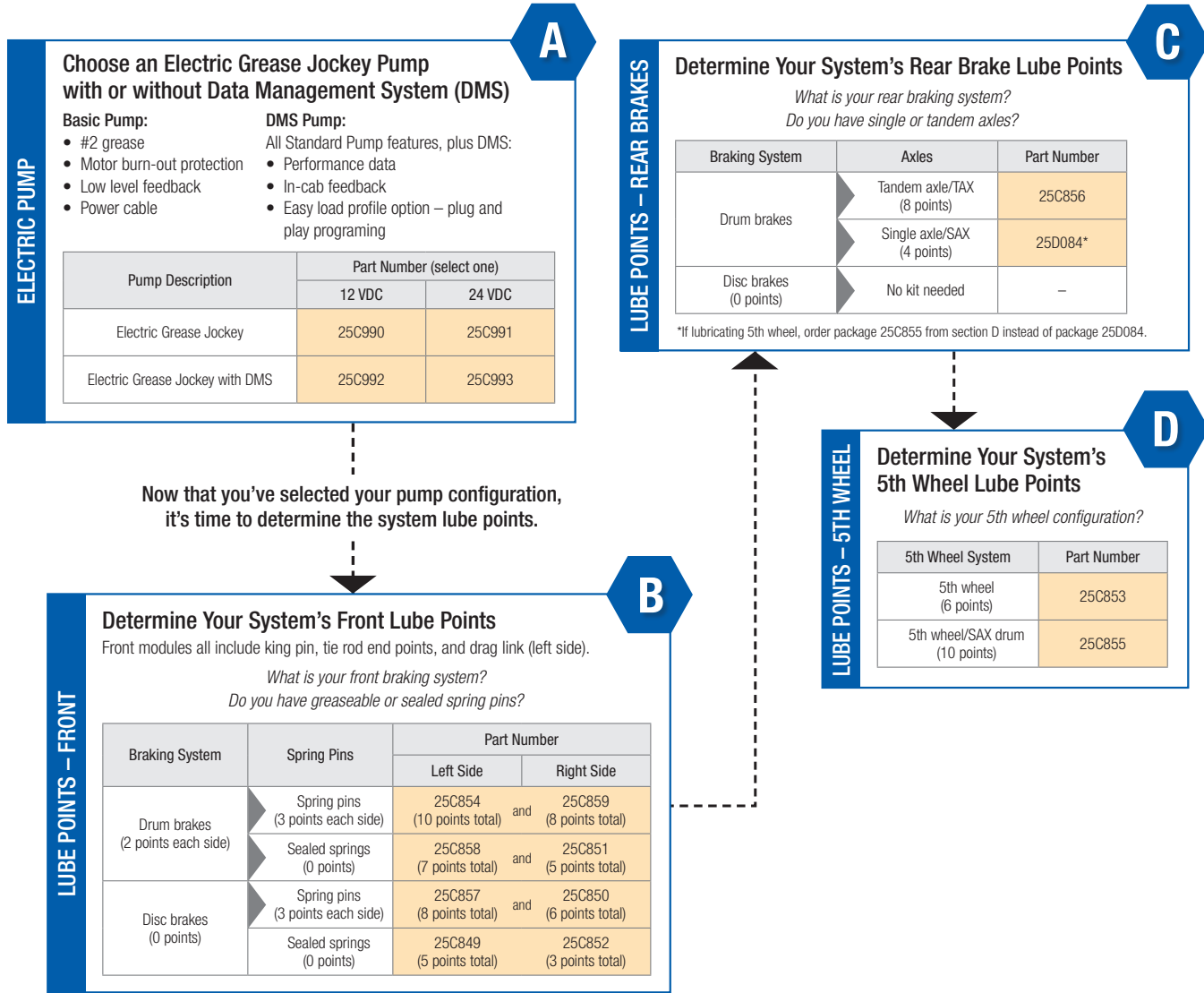

The **NEW G-Mini®** Compact Electric Pump is also suitable for on-road mobile lubrication applications. Refer to pages 13-14 for details.

Ordering Information

Electric Grease Jockey Pump Packages

	Package Number	25C990	25C991	25C992	25C993
Package Includes	Pump	24Z764	24Z959	24Z660	24Z958
	Power	12V	24V	12V	24V
	Data Management System	–	–	Yes	Yes
	Power Cable	129644	129644	127782	127782
	Manual Run Button	–	–	25C981	25C982

Electric Grease Jockey System Installation Kits

	Package Number	Truck with Greaseable Spring Pins			Truck with Sealed Spring Pins (non-greaseable)		
		Drum Brakes		Disc Brakes	Drum Brakes		Disc Brakes
		6 x 4 Tandem Axle	4 x 2 Single Axle		6 x 4 Tandem Axle	4 x 2 Single Axle	
		32 Point / 4 Module Kit	28 Point / 3 Module Kit	20 Point / 3 Module Kit	26 Point / 4 Module Kit	22 Point / 3 Module Kit	14 Point / 3 Module Kit
Package Includes	25C971	25C972	25C973	25C974	25C975	25C976	
	12 VDC Grease Jockey pump	25C990			25C990		
	18 ft mainline section/installable end kit	17S970			17S970		
	12 ft mainline section/installable end kit	17S969			17S969		
	6 ft mainline section/installable end kit (qty)	17S968 (2)	17S968 (1)	17S968 (1)	17S968 (2)	17S968 (1)	17S968 (1)
	Mainline tee (qty)	129759 (3)	129759 (2)	129759 (2)	129759 (3)	129759 (2)	129759 (2)
	Mainline elbow (2)	129755			129755		
	Front left meter module	25C854	25C854	25C857	25C858	25C858	25C849
	Front right meter module	25C859	25C859	25C850	25C851	25C851	25C852
	5th wheel meter module	25C853	25C855	25C853	25C853	25C855	25C853
	Rear axle meter module	25C856		–	25C856		–
	3/16 in to 1/8 NPT elbows, 10-Pack (qty)	25C977 (3)	25C977 (3)	25C977 (2)	25C977 (3)	25C977 (2)	25C977
	3/16 in to 1/8 NPT straights, 10-Pack	25C978			25C978		
	1/4-28 SAE to 1/8 NPT (F), 5-Pack	25C979			25C979		
	Mounting bracket	17S107			17S107		
Zip ties, 100-count	17K063			17K063			
Zip ties, looped, 10-count (qty)	25C980 (3)	25C980 (2)	25C980 (1)	25C980 (3)	25C980 (2)	25C980 (1)	

# Electric Grease Jockey® Manifolds

## Customize and Commonize Your Fleet Lubrication

Grease Jockey modular design makes it easy to add or subtract lube points and commonize service parts across your fleet. Modules hold up to 6 or 12 lubrication point meters.

Updated for NLGI #2 Grease

Multiple Mounting and Plumbing Options

Same Pre-Charged, Color Coded Lines and End-Point Fittings

12-Port and 6-Port Options

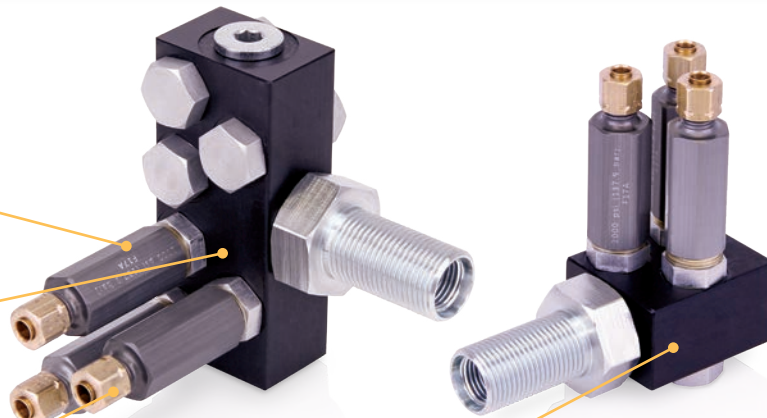





### Ordering Information

#### Build Your Own Module

Part Number	24Z682	24Z683	24Z684	24Z685	24Z686	24Z681
Grease Jockey Injector Size	#0	#1	#2	#3	#4	#8
Output Spacers	0	1	2	3	4	4
Dispense Amount in <sup>3</sup> (cm <sup>3</sup> )	0.002 (0.03)	0.005 (0.08)	0.009 (0.15)	0.012 (0.20)	0.015 (0.25)	0.026 (0.43)
Typical Truck/Trailer Lube Points	S-Cam, Clutch	Slack Adjuster, Pivot Pins	Tie-Rod End, Drag Link	King Pin, Spring Pin	5th Wheel Cylinders	5th Wheel Face Plate

#### Metering Module Service Items and Accessories

	Part Number	Description
<i>Image Coming Soon</i>	25D012	One replacement #3 meter with pre-charged, 15 ft tube
	25D013	Two replacement #3 meters with pre-charged, 15 ft 2-tube bundle
<i>Image Coming Soon</i>	26C105	Two replacement #4 meters with pre-charged 30 ft 2-tube bundle
	15W165	Feed Line, 3/16 in tube, pre-charged, 30 ft, black
	563789	Feed Line, 3/16 in tube, pre-charged, 15 ft, orange
	564090	Feed Line, 3/16 in 2-tube bundle, pre-charged, 30 ft, orange/black

	Part Number	Description
	563796	Feed Line 3/16 in 3-tube bundle, pre-charged, 30 ft, orange/blue/black
<i>Image Coming Soon</i>	24Z808	Manifold meter port plugs with O-rings
	129752	Manifold inlet plugs
	25C988	Bare manifold with stem, nut and washer, 6 port
	25C989	Bare manifold with stem, nut and washer, 12 port

## Injectors Designed for Frequent Medium-Pressure Metering

Designed for frequent metering and includes system pressure monitoring.

### Compression Nut With Captured Ferrule Included

For fast, easy connection to 3/16 in OD tubing.

### Injectors Come In Six Sizes

To meet a wide range of lube requirements.

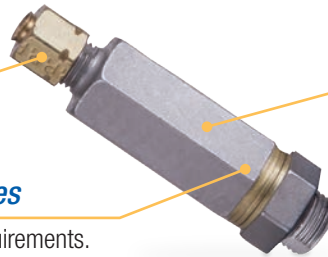

### Adjustable Output Volume

Easy to adjust by adding or removing spacers, design also prevents tampering.

#### Typical Applications

- On road mobile equipment such as trucks, semi-tractors, semi-trailers, and other vehicles and on-highway equipment.

#### Typical Fluids

- Grease up to NLGI #2

#### Technical Specifications

Maximum Operating Pressure	2,000 psi (138 bar)
Minimum Operating Pressure	450 psi (31 bar)
Reset Pressure	250 psi max (17.2 bar)
Maximum Temperature	149°F (65°C)
Cycle Indication	Optional cycle indicator, 563769
Wetted Parts	Aluminum, nitrile rubber (Buna-N), brass, carbon steel, alloy steel
Instruction Manual	312054, 3A5082

### Ordering Information

Part Number	Size #	Output in <sup>3</sup> (cm <sup>3</sup> )	Adjustment Spacers Quantity
24Z682	0	0.002 (0.033)	0
24Z683	1	0.005 (0.082)	1
24Z684	2	0.009 (0.15)	2
24Z685	3	0.012 (0.19)	3
24Z686	4	0.015 (0.25)	4
24Z681	8	0.026 (0.43)	4

### Accessories



Part Number	Description
563769	Injector Cycle Indicator – installs in outlet of each injector, converts outlet to 1/8 in OD tubing
556665	Replacement 1/8 in tube nut for cycle indicator 563769
556660	Replacement 3/16 in tube nut for injector outlets
557901	Injector Outlet Plug – used to disable unneeded injectors without removing from manifold
557898	Output adjustment spacer, brass
556586	Black replacement O-ring for grease injectors
133804	1/8 in NPT outlet adapter for injectors
24Z808	Injector port plugs with O-ring – used to plug unused injector ports

For manifold options, refer to Grease Jockey Accessories sections.



# Electric Grease Jockey® Accessories

## Ordering Information

### Electric Grease Jockey Pump Accessories

	Part Number	Description
	24Z962	Protective pump cover
	25T767	Pump mounting flat bracket with mounting bolts
<i>Image Coming Soon</i>	25T567	Pump mounting offset bracket. For use inside of frame rail; requires 25T767 flat bracket.
<i>Image Coming Soon</i>	557966	Universal "Swiss Cheese" Flat Mounting Adapter
<i>Image Coming Soon</i>	25A170	Fill extension kit
	25C983	Output doubling kit
<i>Image Coming Soon</i>	25C985	Fuse kit, in-line, 12 VDC
<i>Image Coming Soon</i>	25C986	Fuse kit, in-line, 24 VDC

### Electric Grease Jockey Pump Service Items

	Part Number	Description
	24Z764	12 VDC, 2 L, bare pump with vent valve
	24Z959	24 VDC, 2 L, bare pump with vent valve
	24Z660	DMS, 12 VDC, 2 L, bare pump with vent valve
	24Z958	DMS, 24 VDC, 2 L, bare pump with vent valve
<i>Image Coming Soon</i>	25V700	2L G-Mini Jockey, 12V
	25V701	1L G-Mini Jockey, 12V

## Ordering Information

### Electric Grease Jockey Pump Service Items (Cont.)

	Part Number	Description
<i>Image Coming Soon</i>	129644	Power cable, 30 ft (9.1 m), 2-wire CPC to flying leads
	127782	DMS power cable, 30 ft (9.1 m), 5-wire CPC to flying leads
<i>Image Coming Soon</i>	17S477	Power cable, 3 ft (1 m), 2-wire CPC to 2-pin automotive connector
	25C981	Manual run button, 12 VDC
	25C982	Manual run button, 24 VDC
<i>Image Coming Soon</i>	25C987	Electric Grease Jockey pump element
<i>Image Coming Soon</i>	25C965	Vent valve assembly, 12 VDC
<i>Image Coming Soon</i>	25C966	Vent valve assembly, 24 VDC
<i>Image Coming Soon</i>	129801	Vent valve power cable
<i>Image Coming Soon</i>	25V702	G-Mini Jockey Timer with Cable
<i>Image Coming Soon</i>	25V703	GLC 2200 Timer Kit
<i>Image Coming Soon</i>	25V704	Pressure Switch Kit
<i>Image Coming Soon</i>	25V705	Injector Bracket Kit

# Electric Grease Jockey® Accessories

## Ordering Information

### Metering Modules

Front Modules all include king pin and tie rod end points.



	Part Number	Description
	25C849	Left Front – 5 points (Drag Link)
	25C850	Right Front – 6 points (Spring Pins)
	25C851	Right Front – 5 points (Drum Brakes)
	25C852	Right Front – 3 points
	25C853	5th Wheel – 6 points (Plate, Pivot pins)
	25C854	Left Front – 10 points (Spring Pins, Drum Brakes, Drag Link)
	25C855	5th Wheel – 10 points (Single Axle Drum Brakes, Plate, Pivot pins)
	25C856	Tandem axle – 8 points (Drum Brakes)
	25C857	Left front – 8 points (Spring Pins, Drag Link)
	25C858	Left front – 7 points (Drum Brakes, Drag Link)
	25C859	Right Front – 8 points (Spring Pins, Drum Brakes)
	25D084	Single axle – 4 points (Drum Brakes)
	26C081	TAX/5th Wheel – 14 point (Drum Brakes, Plate, Pivot pins) Double Module
	26C101	Drop Axle, 8 Point (King Pins, drum brakes)
	26C100	Drop Axle, 10 Point (King Pins, Tie-rod ends, drum brakes)
	26C104	Dump Body, 10 Point
25D216	6 point (#3) meter module, pre-charged lines	
25D217	12 point (#3) meter module, pre-charged lines	

Notes: **Meter modules do not include end-point fittings.** Customized meter modules available upon request, minimum order 50 units.

### Lubricant

	Part Number	Description
	557941	NLGI #00 grease, 35 lb bucket

### Grease Jockey Fill Pump Kits

	Part Number	Description
	26A318	Mini Fire-Ball 35 lb fill pump kit
	26A319	Mini Fire-Ball 120 lb fill pump kit
	26A320	Mini Fire-Ball 400 lb fill pump kit
	247886	Manual 35 lb fill pump kit
	121474	Coupler, hydraulic quick disconnect, 1/4 in NPT

## Ordering Information

### End-Point Fittings (not included with injector manifolds) and Installation Accessories

	Part Number	Description
	25C977	10 pack of P/N 556638, 3/16 in OD tube to 1/8 NPT elbows
	26A405	200 pack of P/N 556638, 3/16 in OD tube to 1/8 NPT elbows
	25C978	10 pack of P/N 556644, 3/16 in OD tube to 1/8 NPT straight connectors
	26A404	200 pack of P/N 556644, 3/16 in OD tube to 1/8 NPT straight connectors
	25C979	5 pack of P/N 15K740, 1/4-28 SAE (m) to 1/8 NPT(F) elbow, 90°
	26A406	100 pack of P/N 15K740, 1/4-28 SAE (m) to 1/8 NPT(F) elbow, 90°
	556660	3/16 in tube nut sleeve with captivated ferrule
	15K783	1/8 NPT(M) to 1/8 NPT(F) elbow, 90°
	560534	1/8 NPT(M) to 1/8 NPT(F) elbow, 45°
	557392	0.75 in extension, 1/8 NPT(M) to 1/8 NPT(F)
	557393	1.25 in extension, 1/8 NPT(M) to 1/8 NPT(F)
<i>Image Coming Soon</i>	25M544	6 ft conduit sleeve
	17K063	Cable ties, 100 pack
	25C980	Figure-8 cable ties, 10 pack
<i>Image Coming Soon</i>	26C326	Mainline purge adapter, JIC-6 x 1/4 in QD male

## Keep Your Chassis Operating, Even in Harsh On-Road Conditions

Lubricant goes where it's supposed to, automatically, with little or no waste. Field-proven – some of the largest fleets have been using Grease Jockey for decades.



### High-Strength, Shatter-Resistant Reservoir

Utilizes a high-quality, polycarbonate reservoir that is securely mounted to the pump with rigid tie rods for optimal sealing.

### Field-Proven Reliability

Over four decades of over-the-road experience.

### Rugged Cast Aluminum Construction

9:1 pump with 6 lb capacity.

### High-Capacity Fill Port

Saves time and keeps you on the road.

### Digital Control Timer

PIN code lockout keeps your air-powered lubrication system profile safe.



### Technical Specifications

Construction	Cast aluminum body and bracket
Lubricant	NLGI #0, #00 or #000 grease
Output per Cycle	1.5 in <sup>3</sup> (24.6 cm <sup>3</sup> )
Reservoir Capacity	6 lb (2.7 kg), 12 lb (5.4 kg)
Inlet Supply (dry) (air pump)	150 psi (1034 kPa) max; 60 psi (414 kPa) min
Air-to-Lube Ratio (maximum)	9:1
Solenoid Voltage (air)	12 or 24 VDC
Electrical	9 to 32 VDC (12 or 24 VDC Nominal)
Enclosure (air pump)	High-impact sealed plastic
Component Technology	Solid-state
Pump "ON" Time	Programmable: 1 second to 99 minutes
Lube Cycle Frequency	Programmable: 1 minute to 99 hours
Main Supply to Modules	5/16 in O.D. heavywall nylon
Module to Point	3/16 in O.D. heavywall nylon
Operating Pressure (nylon lines)	1,350 psi (9,310 kPa)
Instruction Manual	312054

Ordering Information



Pneumatic Grease Jockey Pumps

	Package Number	563625	563589	563590	563593	563888	563854	563874
Package Includes	Reservoir Size	Pump only	6 lb	12 lb	6 lb	6 lb	6 lb	12 lb
	Fill Port	Straight	Straight	Straight	Elbow	Elbow	Straight	Straight
	Solenoid	–	–	–	–	12 VDC	12 VDC	12 VDC
	Timer/Wiring Harness Kit	–	–	–	–	–	25A118	25A118
	Mounting Plate	–	–	–	–	–	Yes	Yes
	Mainline and Hardware	–	–	–	–	–	Yes	Yes
	Extra Fittings Kit	–	–	–	–	–	Yes	Yes

Pneumatic Grease Jockey System Installation Kits

	Package Number	Truck with Greaseable Spring Pins			Truck with Sealed Spring Pins (non-greaseable)		
		Drum Brakes		Disc Brakes	Drum Brakes		Disc Brakes
		6 x 4 Tandem Axle	4 x 2 Single Axle		6 x 4 Tandem Axle	4 x 2 Single Axle	
		<i>34 Point / 4 Module Kit</i>	<i>28 Point / 3 Module Kit</i>	<i>20 Point / 3 Module Kit</i>	<i>26 Point / 4 Module Kit</i>	<i>22 Point / 3 Module Kit</i>	<i>14 Point / 3 Module Kit</i>
		563814	24Z809	24Z810	24Z811	24Z812	24Z813
Package Includes	12 VDC Grease Jockey Pump and Reservoir	563589 / 563854	24Z526	24Z526	24Z526	24Z526	24Z526
	Front Left Meter Module	563644	24W623	563654	563706	563706	563728
	Front Right Meter Module	563645	563858	563655	24W335	24W335	24H994
	5th Wheel Meter Module	563648	258348	563648	563648	258348	563648
	Rear Axle Meter Module	563646		–	563646		–
	Mounting Bracket	128256	128256	128256	128256	128256	128256
	Control Timer		25A118		25A118		

Accessories

	Part Number	Description
	128256	Mounting bracket
	24W482	Digital control timer for air-powered systems

## How to Select Your Graco Pneumatic Grease Jockey Automatic Lubrication System

Determining the Pneumatic Grease Jockey system best suited to your needs is accomplished by using the following steps.

On-Road Lubrication Systems

A

### Pneumatic Grease Jockey Pump

Pump Description	Part Number
Pneumatic Grease Jockey 9:1 ratio, 6 lb reservoir, 12 VDC, controller, solenoid, mainline, and mounting hardware	563854

Now that you've selected your pump configuration, it's time to determine the system lube points.

B

LUBE POINTS – FRONT LEFT

### Determine Your System's Front Left Lube Points

*What is your front braking system?  
Do you have greaseable or sealed spring pins?*

Braking System	Spring Pins	Part Number
Drum brakes (2 points)	Spring lube (3 points)	563644 (10 points total)
	Sealed springs (0 points)	563706 (7 points total)
Disc brakes (0 points)	Spring lube (3 points)	563654 (8 points total)
	Sealed springs (0 points)	563728 (5 points total)

C

LUBE POINTS – FRONT RIGHT / TRANSMISSION

### Determine Your System's Front Right / Transmission Lube Points

*Does your transmission have lube points? What is your front braking system?  
Do you have greaseable or sealed spring pins?*

Clutch Points	Braking System	Spring Pins	Part Number
2 clutch points	Drum brakes (2 points)	Spring lube (3 points)	563645 (10 pts total)
		Sealed springs (0 points)	563859 (7 pts total)
	Disc brakes (0 points)	Spring lube (3 points)	24X743 (8 pts total)
		Sealed springs (0 points)	563727 (5 pts total)
No clutch points	Drum brakes (2 points)	Spring lube (3 points)	563858 (8 pts total)
		Sealed springs (0 points)	563860 (5 pts total)
	Disc brakes (0 points)	Spring lube (3 points)	563655 (6 pts total)
		Sealed springs (0 points)	24H994 (3 pts total)

D

LUBE POINTS – REAR BRAKES

### Determine Your System's Rear Brake Lube Points

*What is your rear braking system?  
Do you have single or tandem axles?*

Braking System	Axles	Part Number
Drum brakes	Tandem axle/TAX (8 points)	563646
	Single axle/SAX (4 points)	563647*
Disc brakes (0 points)	No kit needed	–

\*If lubricating 5th wheel, order package 258348 from Section E instead of package 563647.

E

LUBE POINTS – 5TH WHEEL

### Determine Your System's 5th Wheel Lube Points

*What is your 5th wheel configuration?*

5th Wheel System	Part Number
5th wheel (6 points)	563648
5th wheel/SAX drum (10 points)	258348

ADDITIONAL SYSTEM PRODUCTS

### Additional Grease Jockey System Products

Product Description	Part Number
Steering assist lube points for front right	563862 (2 points)
Steerable drop axle lube points	564194 (10 points)
Non-steerable drop axle lube points	563856 (6 points)
Dump body kit	563857 (6 points)

## Standard Graco Warranty

### 1-Year Warranty Policy

Graco warrants all equipment manufactured by Graco and bearing its name to be free from defects in material and workmanship on the date of sale by an authorized Graco distributor to the original purchaser for use. With the exception of any special, extended, or limited warranty published by Graco, Graco will, for a period of twelve (12) months from the date of sale, repair or replace any part of the equipment determined by Graco to be defective.

This warranty applies only when the equipment is installed, operated and maintained in accordance with Graco's written recommendations. This warranty does not cover, and Graco shall not be liable for general wear and tear, or any malfunction, damage or wear caused by faulty installation, misapplication, abrasion, corrosion, inadequate or improper maintenance, negligence, accident, tampering, or substitution of non-Graco component parts. Nor shall Graco be liable for malfunction, damage or wear caused by the incompatibility of Graco equipment with structures, accessories, equipment or materials not supplied by Graco, or the improper design, manufacture, installation, operation or maintenance of structures, accessories, equipment or materials not supplied by Graco.

This warranty is conditioned upon the prepaid return of the equipment claimed to be defective to an authorized Graco distributor for verification of the claimed defect. If the claimed defect is verified, Graco will repair or replace free of charge any defective parts. The equipment will be returned to the original purchaser transportation prepaid. If inspection of the equipment does not disclose any defect in material or workmanship, repairs will be made at a reasonable charge, which charges may include the costs of parts, labor, and transportation.

THIS WARRANTY IS EXCLUSIVE, AND IS IN LIEU OF ANY OTHER WARRANTIES, EXPRESS OR IMPLIED, INCLUDING BUT NOT LIMITED TO WARRANTY OF MERCHANTABILITY OR WARRANTY OF FITNESS FOR A PARTICULAR PURPOSE.

Graco's sole obligation and buyer's sole remedy for any breach of warranty shall be as set forth above. The buyer agrees that no other remedy (including, but not limited to, incidental or consequential damages for lost profits, lost sales, injury to person or property, or any other incidental or consequential loss) shall be available. Any action for breach of warranty must be brought within two (2) years of the date of sale.

Graco makes no warranty, and disclaims all implied warranties of merchantability and fitness for a particular purpose in connection with accessories, equipment, materials or components sold but not manufactured by Graco. These items sold, but not manufactured, by Graco (such as electric motors, switches, hose, etc.) are subject to the warranty, if any, of their manufacturer. Graco will provide purchaser with reasonable assistance in making any claim for breach of these warranties.

In no event will Graco be liable for indirect, incidental, special or consequential damages resulting from Graco supplying equipment hereunder, or the furnishing, performance, or use of any products or other goods sold hereto, whether due to a breach of contract, breach of warranty, the negligence of Graco, or otherwise.

# Graco Automatic Lubrication Equipment Extended Warranty

This warranty does not cover, and Graco shall not be liable for, general wear and tear, or any malfunction, damage or wear caused by faulty installation, misapplication, abrasion, corrosion, inadequate or improper maintenance, negligence, accident, tampering, or substitution of non-Graco component parts. Nor shall Graco be liable for malfunction, damage or wear caused by the incompatibility of Graco equipment with structures, accessories, equipment or materials not supplied by Graco, or the improper design, manufacture, installation, operation or maintenance of structures, accessories, equipment or materials not supplied by Graco.

This warranty is conditioned upon the prepaid return of the equipment claimed to be defective to an authorized Graco distributor for verification of the claimed defect. If the claimed defect is verified, Graco will repair or replace free of charge any defective parts. The equipment will be returned to the original purchaser transportation prepaid. If inspection of the equipment does not disclose any defect in material or workmanship, repairs will be made at a reasonable charge, which charges may include the costs of parts, labor, and transportation.

THIS WARRANTY IS EXCLUSIVE, AND IS IN LIEU OF ANY OTHER WARRANTIES, EXPRESS OR IMPLIED, INCLUDING BUT NOT LIMITED TO WARRANTY OF MERCHANTABILITY OR WARRANTY OF FITNESS FOR A PARTICULAR PURPOSE.

Graco's sole obligation and buyer's sole remedy for any breach of warranty shall be as set forth above. The buyer agrees that no other remedy (including, but not limited to, incidental or consequential damages for lost profits, lost sales, injury to person or property, or any other incidental or consequential loss) shall be available. Any action for breach of warranty must be brought within one (1) year post the warranty period.

GRACO MAKES NO WARRANTY, AND DISCLAIMS ALL IMPLIED WARRANTIES OF MERCHANTABILITY AND FITNESS FOR A PARTICULAR PURPOSE, IN CONNECTION WITH ANY ACCESSORIES, EQUIPMENT, MATERIALS OR COMPONENTS SOLD BUT NOT MANUFACTURED BY GRACO.

These items sold, but not manufactured, by Graco (such as electric motors, switches, etc.) are subject to the warranty, if any, of their manufacturer. Graco will provide purchaser with reasonable assistance in making any claim for breach of these warranties.

In no event will Graco be liable for indirect, incidental, special or consequential damages resulting from Graco supplying equipment hereunder, or the furnishing, performance, or use of any products or other goods sold hereto, whether due to a breach of contract, breach of warranty, the negligence of Graco, or otherwise.

### FOR GRACO CANADA CUSTOMERS

The parties acknowledge that they have required that the present document, as well as all documents, notices and legal proceedings entered into, given or instituted pursuant hereto or relating directly or indirectly hereto, be drawn up in English.

Les parties reconnaissent avoir convenu que la rédaction du présent document sera en Anglais, ainsi que tous documents, avis et procédures judiciaires exécutés, donnés ou intentés à la suite de ou en rapport, directement ou indirectement, avec les procédures concernées.

# Graco Automatic Lubrication Equipment Extended Warranty (cont.)

Graco warrants all equipment referenced in this document that is manufactured by Graco and bearing its name to be free from defects in material and workmanship on the date of sale to the distributor. Graco will, for a period as defined in the table below

from the date of sale, repair or replace equipment covered by this warranty and determined by Graco to be defective. This warranty applies only when the equipment is installed, operated, and maintained in accordance with Graco's written recommendations.

Products	Warranty Period
<b>Oil King, Coolant King and Oil Ace</b>	5 Years
<b>Pulse Fluid Management HUBs, TLMS, PACs and Extenders</b>	2 Years
<b>Pulse Level</b>	2 Years
<b>GCI and GL-1 X Injectors</b>	2 years
<b>Electric Grease Jockey</b>	5 Years
<b>Cord and Light Reels</b>	2 Years
Electrical Components	1 Year
<b>LDX Series Hose Reels</b>	5 Years
Wear Parts, including but not limited to hose, seals, swivel seats and roller guides	1 Year
<b>SDX Series Hose Reels</b>	7 Years
Power Springs	3 Years
Wear Parts, including but not limited to hose, seals, swivel seats and roller guides	1 Year
<b>XD and XDX Series Hose Reels</b>	7 Years
Power Springs	3 Years
Wear Parts, including but not limited to hose, seals, swivel seats, roller guides and motors	1 Year
<b>Mechanical Meters</b>	5 years
Wear parts, including but not limited to O-rings, seals and valves	1 Year
<b>LD Preset Meters</b>	5 years
Electronics	2 Years
Wear parts, including but not limited to O-rings, seals and valves	1 Year
<b>EM, Pulse and SD Meters</b>	5 Years
Electronics	3 Years
Wear parts, including but not limited to O-rings, seals and valves	1 Year
<b>LD Oil/Grease Pumps</b>	5 Years
Wear Parts, including but not limited to O-rings, packings and seals	1 Year
Hoses with pump packages	1 Year
<b>AODD Pumps</b>	5 Years
Wear Parts, including but not limited to O-rings, packings and seals	1 Year
Hoses with pump packages	1 Year
<b>Mini Fire-Ball 225 and Fire-Ball 300 Oil and Grease Pumps</b>	7 Years
Wear Parts, including but not limited to O-rings, packings and seals	1 Year
Hoses with pump packages	1 Year
<b>Fire-Ball 425 Oil and Grease Pumps</b>	10 Years
Wear Parts, including but not limited to O-rings, packings and seals	1 Year
Hoses with pump packages	1 Year
<b>Fast-Ball and FastBall-100</b>	5 Years
<b>LD Blue and SD Blue Diesel Exhaust Fluid Pumps</b>	2 Years

# Index

Part No.	Page No.	Part No.	Page No.	Part No.	Page No.
15D936	186	17J423	135, 205	17R571	208
15E279	191	17J939	26, 100	17R572	208, 214
15H304	182	17J999	21	17R573	208
15K740	245	17K061	177, 180	17R574	208
15K783	177, 215, 245	17K062	180	17R575	208
15K784	177	17K063	107, 206, 239, 245	17R576	208
15M037	206	17K601	121	17R577	208
15M045	177	17K602	121	17R578	208
15M442	80, 81	17K603	121	17R703	14, 124
15M805	191	17K604	121	17S107	239
15M861	192	17K615	187	17S392	121
15M863	195	17L366	51, 174	17S393	121
15R130	74	17L372	81	17S394	121
15R993	153	17L437	211	17S395	121
15R994	153	17L438	211	17S396	121
15U857	159	17L440	218	17S477	243
15W165	215, 240	17L441	124, 211	17S552	207
15X886	192	17L442	211	17S553	207
15X983	193	17L446	214	17S554	207
15Y070	139	17L447	214	17S555	207
15Y925	186	17L448	214	17S556	213
15Y934	186	17L449	209	17S557	213
16A169	215	17L455	214	17S558	213
16A171	163, 216	17L456	214	17S559	213
16A172	216	17L457	214	17S968	239
16A361	196	17L458	124, 209	17S969	239
16A362	196	17L543	214	17S970	239
16C398	195	17L545	209	17T176	60
16C399	195	17L546	208	17T177	60
16C475	192	17L547	211	17T178	60
16C637	192	17L548	208	17T179	60
16D939	178	17L550	124, 208	17T193	60
16F255	178	17L647	211	17T194	60
16F259	181	17L648	207, 208	17T195	60
16H491	192	17L649	208, 209	17T196	60
16J975	192	17L650	208	17T211	196
16P292	179	17L651	124	17T246	181
16P368	139	17L652	218	17T780	208
16R882	191	17L653	218	17T781	208
16R883	191	17L680	209	17T782	208
16T315	180	17L692	218	17T783	208, 214
16T671	102, 104	17L706	204	17U217	60
16U217	134, 147, 155	17L754	121	17U308	188
16U790	14, 28, 136	17L755	121	17U319	188
16U878	186	17L875	187	17U325	187
16U879	186	17L879	14, 26, 124, 161	17U385	187
16V432	185	17L880	150, 156, 161	17V389	189
16V434	188	17L881	159, 161	17V721	214
16V678	51	17L898	187	17V731	187
16V999	22	17L899	187	17Y235	189
16W608	187	17L941	211	17Y236	189
16W609	188	17L942	212	17Y489	121
16W610	188	17L983	26, 135, 142, 161	17Y498	121
16W611	189	17M153	88	17Y510	121
16Y235	178	17M380	125, 128, 161	17Y511	121, 122
17B168	116	17N453	121	17Y689	209
17B169	116	17N454	121	17Y690	209
17B780	116	17N455	121	17Y691	209
17B781	116	17N456	121	17Y692	124
17B782	116	17N457	121	17Y693	124
17B783	116	17N458	121	18B302	179
17B785	116	17N926	21	18C750	62
17B879	116	17P336	213	18C751	62
17B880	116	17P337	213	18C752	62
17C750	62	17P339	106	18C753	62
17C751	62	17P340	107	19A574	142
17C752	62	17P750	60	19B227	141
17C753	62	17P751	60	19B332	188
17D023	205	17P752	60	20A081	136
17D024	205	17P753	60	20A339	136
17D688	106	17R565	207	20A585	136
17G007	99, 102	17R566	207	20A586	136
17G388	178	17R567	214	20A900	136
17G422	180	17R568	214	20A901	136
17G704	187	17R569	209	20A902	136
17G711	178	17R570	209	20A903	136

Part No.	Page No.	Part No.	Page No.	Part No.	Page No.
20A904	136	24G487	131	24R873	115
24A918	122	24G488	131	24R952	51
24A919	114	24G489	131	24T296	166
24A920	114	24G490	131	24T306	228
24A921	114	24H994	247, 248	24U750	90, 227
24A922	114	24J391	223, 228	24V068	90, 227
24A923	114	24J392	223, 228	24V837	21
24A924	114	24J393	223, 228	24W335	247
24B237	163	24J394	228	24W401	115
24B239	163	24J395	228	24W402	115
24B240	163	24J396	228	24W403	115
24B241	163	24J397	228	24W404	115
24B359	122	24J398	228	24W405	115
24B360	114	24J399	228	24W406	115
24B474	140	24J814	163	24W407	115
24B475	140	24J815	163	24W408	115
24B476	140	24J816	163	24W482	104, 247
24B477	140	24J817	163	24W483	115
24B478	140	24K414	26, 203	24W484	115
24B479	140	24K415	166	24W485	115
24B480	140	24K466	228	24W486	115
24B481	140	24K466	56, 223, 226	24W487	115
24B482	140	24M478	28	24W488	115
24B483	140	24M479	28	24W489	115
24B495	141	24M480	28	24W490	115
24B496	141	24M481	28	24W491	115
24B497	139	24M482	28	24W492	115
24B498	139	24M483	28	24W493	115
24B591	100	24M484	28	24W494	115
24B596	100	24M644	14, 24, 205	24W495	116
24B677	116	24N181	26, 51, 76, 81, 203	24W501	115
24E240	114	24N182	28	24W502	115
24E241	114	24N351	28, 67	24W503	115
24E242	114	24N369	139	24W504	115
24E243	114	24N373	141	24W505	115
24E244	114	24N382	138	24W506	115
24E245	114	24N383	138	24W507	115
24E389	114	24N384	138	24W601	115
24E390	114	24N385	138	24W602	115
24E391	114	24N386	138	24W603	115
24E392	114	24N388	138	24W604	115
24E393	114	24N389	138	24W605	115
24E394	114	24N390	138	24W606	115
24E691	204	24N391	138	24W607	115
24F201	114	24N392	138	24W623	247
24F507	114	24N402	28	24W633	90, 227
24F508	114	24N405	45	24W634	90, 227
24F509	114	24N406	45	24W635	90, 227
24F510	114	24N407	45	24W636	90, 227
24F511	114	24N408	45	24W701	115
24F512	114	24N409	45	24W702	115
24F513	116	24N468	102	24W703	115
24F514	116	24N724	90, 227	24W704	115
24F542	114	24N776	72	24W705	115
24F543	114	24N915	131	24W706	115
24F544	114	24N916	131	24W707	115
24F545	114	24N917	131	24W801	115
24F546	114	24N918	131	24W802	115
24F548	114	24N919	131	24W803	115
24F550	114	24N920	131	24W804	115
24F551	114	24N945	141	24W805	115
24F552	114	24N948	141	24W806	115
24F553	114	24N949	141	24W807	115
24F554	114	24N951	141	24W808	115
24F555	116	24N952	141	24W865	193
24F556	116	24P295	21	24W901	115
24F596	144	24P296	21	24W902	115
24F597	144	24P314	102	24W903	115
24F598	144	24P548	189	24W904	115
24F599	144	24P686	102, 104	24W905	115
24F600	144	24P687	102, 104	24W906	115
24F601	144	24P731	27	24W907	115
24F943	116	24P976	166	24W913	115
24F944	114	24R631	140	24W914	115
24G485	131	24R632	140	24W915	115
24G486	131	24R633	140	24W981	102

# Index

Part No.	Page No.	Part No.	Page No.	Part No.	Page No.
24X027	146	24Z504	123	25C987	243
24X028	146	24Z505	123	25C988	240
24X029	146	24Z506	123	25C989	240
24X030	146	24Z507	123	25C990	238, 239
24X302	115	24Z508	123	25C991	238, 239
24X303	115	24Z509	123	25C992	238, 239
24X304	115	24Z510	123	25C993	238, 239
24X305	115	24Z511	123	25D012	240
24X306	115	24Z512	123	25D013	240
24X307	115	24Z526	247	25D084	238, 244
24X401	120	24Z660	239, 242	25D096	76
24X402	120	24Z675	153	25D216	244
24X403	120	24Z681	240, 241	25D217	244
24X405	120	24Z682	240, 241	25D336	121
24X606	102, 104	24Z683	240, 241	25E349	121
24X743	248	24Z684	240, 241	25E935	124
24X807	120	24Z685	240, 241	25M496	211
24Y079	63	24Z686	240, 241	25M497	211
24Y080	63	24Z714	161	25M544	245
24Y081	63	24Z715	161	25M602	26, 161
24Y082	63	24Z719	161	25M603	26, 161
24Y407	80	24Z720	161	25M604	161
24Y408	80	24Z764	239, 242	25N013	213
24Y498	62	24Z808	240, 241	25N101	120
24Y499	62	24Z809	247	25N104	120
24Z020	61	24Z810	247	25N106	120
24Z021	61	24Z811	247	25N109	120
24Z022	61	24Z812	247	25N624	88
24Z023	61	24Z813	247	25N730	124
24Z024	61	24Z958	239, 242	25R001	47
24Z025	61	24Z959	239, 242	25R318	47
24Z026	61	24Z962	23, 37, 242	25R513	90, 227
24Z027	61	25A071	90, 227	25R557	90, 227
24Z028	61	25A080	121	25R800	14
24Z029	61	25A081	121	25R801	14
24Z030	61	25A118	104, 247	25R802	14
24Z050	61	25A170	242	25R803	14
24Z051	61	25A189	82	25R804	14
24Z052	61	25B514	136	25R806	14
24Z053	61	25B515	136	25R807	14
24Z054	61	25B534	136	25R808	14
24Z055	61	25B535	136	25R810	14
24Z056	61	25C764	21	25R811	14
24Z057	61	25C771	104	25R812	14
24Z058	61	25C849	238, 239, 244	25R813	14
24Z059	61	25C850	238, 239, 244	25R814	14
24Z060	61	25C851	238, 239, 244	25R815	14
24Z061	61	25C852	238, 239, 244	25R817	14
24Z062	61	25C853	238, 239, 244	25R820	14
24Z477	123	25C854	238, 239, 244	25R821	14
24Z478	123	25C855	238, 239, 244	25R824	14
24Z479	123	25C856	238, 239, 244	25R831	14
24Z480	123	25C857	238, 239, 244	25R832	14
24Z481	123	25C858	238, 239, 244	25R833	14
24Z482	123	25C859	238, 239, 244	25R834	14
24Z483	123	25C948	80	25R835	14
24Z484	123	25C949	80	25R837	14
24Z485	123	25C950	81	25T567	242
24Z486	15, 123	25C951	81	25T585	136
24Z487	15, 123	25C965	243	25T641	120
24Z488	15, 123	25C966	243	25T642	120
24Z489	15, 123	25C971	239	25T643	120
24Z490	15, 123	25C972	239	25T644	120
24Z491	15, 123	25C973	239	25T645	120
24Z492	123	25C974	239	25T646	120
24Z493	123	25C975	239	25T649	120
24Z494	123	25C976	239	25T767	242
24Z495	123	25C977	239, 245	25T775	114
24Z496	123	25C978	239, 245	25T847	219
24Z497	123	25C979	239, 245	25T989	53, 89
24Z498	123	25C980	239, 245	25U040	136
24Z499	123	25C981	14, 239, 243	25U041	136
24Z500	123	25C982	14, 239, 243	25U051	136
24Z501	123	25C983	242	25U052	136
24Z502	123	25C985	106, 242	25U053	136
24Z503	123	25C986	106, 242	25U054	136

# Index

Part No.	Page No.	Part No.	Page No.	Part No.	Page No.
25U285	203	77X541	50, 174	96G148	18
25U286	203	77X542	20, 24, 51	96G149	18
25V706	22, 204	77X543	51	96G150	18
25V700	242	77X544	51	96G163	18
25V701	242	77X545	51	96G167	18
25V702	243	77X546	51	96G171	18
25V703	243	77X960	49	96G172	18
25V704	243	77X990	49	96G182	18
25V705	243	95G102	34	96G184	18
26A159	88	95G103	34	96G189	18
26A172	88	95G104	35	96G192	18
26A318	244	95G106	35	96G194	18
26A319	244	95G108	35	96G196	18
26A320	24, 244	95G109	34	96G198	18
26A325	80	95G110	35	96G199	18
26A404	245	95G111	35	96G202	18
26A405	245	95G112	34	96G204	18
26A406	245	96G000	18	96G205	18
26A414	43	96G001	18	96G207	18, 20
26A478	124	96G002	18	96G208	20
26A479	124	96G003	18	96G209	20
26A782	161	96G005	18	96G210	18, 20
26A814	47, 99	96G006	18	96G213	18, 20
26A853	47, 99	96G007	18	96G214	20
26A855	47, 99	96G008	18	96G215	20
26A882	47, 99	96G011	18	96G217	18, 20
26A883	47, 99	96G012	18	96G220	18
26A884	47, 106	96G013	18	96G237	18
26A888	47, 99	96G014	18	96G238	18
26A889	47, 106	96G027	18	96G239	18
26A910	14, 22	96G028	18	96G240	18
26C030	22	96G029	18	96G241	18
26C081	244	96G033	18	96G243	18
26C100	244	96G034	18	96G258	18
26C101	244	96G038	18	96G278	29, 30
26C104	244	96G039	18	96G279	29, 30
26C105	240	96G040	18	96G291	18
26C144	80	96G041	18	96G320	18
26C176	22	96G042	18	96G321	18
26C326	245	96G043	18	96G322	18
26C344	43	96G044	18	96G331	18
26C537	80	96G045	18	96G332	18
26C538	80	96G048	18	96G543	19
26C539	80	96G049	18	96G544	19
26C822	124	96G050	18	96G545	19
26C823	124	96G052	18	96G546	19
26C825	14	96G053	18	96G547	19
26C826	14	96G055	18	96G548	19
26C947	14	96G056	18	96G549	19
26C980	107	96G057	18	96G550	19
77X000	49	96G058	18	96G551	19
77X001	49	96G059	18	96G552	19
77X002	49	96G060	18	96G553	19
77X003	49	96G061	18	96G554	19
77X011	50	96G062	18	96G555	19
77X012	50	96G068	18	96G556	19
77X013	50	96G069	18	96G557	19
77X014	49	96G070	18	96G558	19
77X015	49	96G071	18	96G560	19
77X016	49	96G072	18	96G562	19
77X100	49	96G073	18	96G564	19
77X111	50	96G075	18	96G565	19
77X112	50	96G076	18	96G566	19
77X121	50	96G077	18	96G568	19
77X122	50	96G078	18	96G569	19
77X202	49	96G079	18	96G570	19
77X203	49	96G080	18	96G572	19
77X500	50	96G081	18	96G573	19
77X510	50	96G082	18	96G574	19
77X513	50	96G135	18	96G580	19
77X514	50	96G136	18	96G581	19
77X521	50	96G137	18	96G582	19
77X522	50, 76, 80, 81	96G138	18	96G591	19
77X523	50, 174	96G139	18	96G592	19
77X524	48, 51	96G140	18	96G593	19
77X540	51	96G147	18	96G594	19

# Index

Part No.	Page No.	Part No.	Page No.	Part No.	Page No.
96G595	19	113654	204	121312	188
96G596	19	113786	180	121319	185
96G599	19	113933	191	121321	188
96G600	19	114030	184	121474	14, 24, 37, 63, 205, 244
96G601	19	114172	140, 192	121486	188
96G602	19	114247	194	121658	113
96G603	19	114337	185	121659	113
96G604	19	114373	191	121660	113
96G605	19	114446	193	121661	113
96G606	19	114484	194	121665	113
96G607	19	114488	76	121668	113
96G608	19	114504	191	121907	191
96G609	19	114506	191	121908	193
96G610	19	114874	193	122276	125, 132, 139, 145
96G611	19	114901	120	122311	188
96G612	19	114902	120	122327	177
96G613	19	114903	120	122398	187
96G614	19	114904	120	122400	187
96G615	19	114905	120	122401	189
96G616	19	114909	120	122406	185
96G634	19	114911	120	122520	188
100030	179	114912	120	122533	189
100040	182	114913	120	122656	192
100054	206	114914	120	122711	188
100081	179	114915	120	122715	194
100206	179	114916	118	122717	187
100361	182	115010	153	122718	187
100380	179	115122	22, 76	122719	187
100451	179	115124	51, 76, 81, 203	122720	185
100474	179	115523	23, 37, 204	122721	187
100483	180	115764	177	122722	185
100505	179	116383	204	122727	195
100509	182	116400	192	122737	195
100615	179	116648	183	122763	191
100721	182	116650	179	122767	192
100737	182	116702	185	122786	194
100839	177	116703	185	122841	113
100840	177	116704	185	122844	192
100848	206	116712	195	122861	113
100854	205	116745	183	122862	113
100896	179	116755	177	122866	113
100960	204	116756	177	122868	113
101689	204	116765	185	122869	113
101754	182	116766	186	122888	113
101909	185	117206	120	122889	113
101970	192	117455	185	122961	195
102258	107	117502	187	122963	187
104099	188	117506	187	122967	187
104663	182	117556	189	122968	188
104911	107	117557	189	122970	185
104984	180	117634	187	122991	195
105281	184	117635	187	122992	185
105474	63, 163	117677	187	123024	192
106595	107	117832	185, 213	123094	188
107128	181	117833	185	123106	194
108673	192	118137	177	123107	194
109025	107	118206	120	123108	194
109075	76	118758	179	123135	186
110150	76	118896	188	123136	195
110191	192	119783	184	123140	189
110319	204	119789	177	123147	207
110336	191	119900	191	123251	185
110792	188	119998	185	123358	28
111643	191	120064	188	123379	178
111697	182	120112	189	123417	195
111856	177	120170	189	123514	192
112026	191	120185	185	123528	189
112100	195	120804	188	123553	194
112307	177	121041	194	123596	195
112564	204	121042	194	123597	195
112567	204	121043	194	123598	195
113093	179	121044	194	123599	195
113344	183	121163	181	123683	185
113445	177	121283	177	123684	185
113548	180	121310	185	123787	189
113641	204	121311	185	123788	189

Part No.	Page No.	Part No.	Page No.	Part No.	Page No.
123854	186	126311	27	129644	239, 243
123888	177	126327	187	129752	182, 240
123889	177	126329	187	129755	188, 239
123896	186	126330	187	129759	239
123897	186	126331	161, 203	129763	185
123980	193	126366	194	129764	180
124089	174	126418	194	129801	243
124090	174	126431	189	129872	189
124113	174	126432	187	130280	161
124152	194	126562	195	130281	212
124221	195	126565	194	130282	161
124286	185	126961	189	130283	161
124287	185	126975	195	130883	206
124288	186	126976	186	130938	207
124300	26, 27, 100, 161	126979	194	130965	214
124301	27	127012	205	130966	214
124315	195	127093	186	130992	186
124333	14, 27, 161, 203	127099	182	130993	185
124342	107	127104	180	130996	185
124343	107	127119	192	131164	212
124403	185	127123	27	131169	178
124405	187	127128	189	131206	107
124406	186	127129	189	131214	161
124408	189	127130	185	131215	161
124433	195	127131	185	131216	161
124434	187	127145	206	131229	107
124435	194	127325	189	131230	107
124451	185	127326	189	131236	188
124508	178	127379	204	131430	180
124586	191	127512	205	131466	180
124594	26, 27, 203	127513	205	131524	191
124640	27	127514	205	131525	191
124726	194	127515	205	131526	178
124803	195	127518	184	131817	189
124813	194	127551	215	131944	106
124814	192	127553	218	131945	107
124820	194	127554	215	132019	180
124844	192	127555	218	132089	25
124845	194	127600	195	132090	25
124846	195	127780	14, 37	132091	25
124885	194	127782	239, 243	132092	25
124903	186	127783	14	132093	25
124905	188	128006	205, 211	132095	36
124913	185	128051	107	132139	179
124941	188	128054	191	132154	25
124961	195	128139	121	132155	25
124967	195	128254	63, 70	132163	25, 36
124968	186	128255	63, 70	132187	23, 37
125214	192	128256	247	132188	25
125215	192	128257	63, 70	132440	186
125222	182	128268	215	132571	106
125296	195	128305	63	132924	136
125297	194	128442	196	133090	210
125403	186	128561	210	133095	121
125494	194	128562	210	133281	207
125548	181	128563	212	133282	207
125572	185	128564	212	133457	37
125643	188	128565	212	133643	22, 181, 204
125644	181	128567	181	133644	181
125660	186	128568	181	133645	186
125661	186	128570	210	133668	118
125662	186	128571	210	133789	29, 30
125778	185	128572	210, 212	133791	29, 30
125779	194	128573	210, 212	133804	241
125781	194	128579	210	133910	37
125783	183	128580	210	133919	36
125910	23, 37	128581	212	133958	37
125926	188	128582	212	133960	37
126070	228	128679	210	133991	37
126170	195	128680	212	133994	36
126243	195	128682	212	133995	36
126247	139	128862	210	134010	36
126248	139	129031	174	134011	36
126249	139	129133	194	134105	118
126250	139	129134	195	134142	36
126251	139	129535	179	134167	36

# Index

Part No.	Page No.	Part No.	Page No.	Part No.	Page No.
134169.....	36	161037.....	183	512420.....	181
134170.....	36	161077.....	183	516308.....	192
134178.....	34	161889.....	184	517434.....	192
134179.....	35	162024.....	179	551387.....	204
134180.....	35	162449.....	178	555406.....	153
134250.....	118	162505.....	183	555453.....	175, 176, 177, 178
134337.....	118	162718.....	180	555457.....	140, 192
134338.....	118	164259.....	177	555694.....	162
134339.....	118	164815.....	181	555726.....	218
134340.....	118	165198.....	178	555727.....	165
134341.....	118	166242.....	191	555728.....	165
134342.....	118	166590.....	177	555749.....	185
134343.....	118	166866.....	191	555808.....	182
134344.....	118	166999.....	177	555888.....	206
134354.....	118	175013.....	178	556026.....	228
134362.....	118	185281.....	192	556327.....	132, 139, 145
134363.....	118	191892.....	178	556328.....	153
134364.....	118	192889.....	196	556371.....	128, 132, 145
134365.....	118	194048.....	178	556402.....	179
134366.....	118	200021.....	205	556403.....	179
134372.....	118	202965.....	183	556404.....	179
134373.....	118	206728.....	76	556405.....	179
134374.....	118	207123.....	193	556406.....	179
134375.....	118	208434.....	183	556407.....	181
134376.....	118	209029.....	193	556408.....	178
134393.....	118	215407.....	76	556410.....	182
134410.....	36	217430.....	183	556411.....	182
134411.....	36	222297.....	184	556416.....	180
150171.....	180	234412.....	163	556419.....	181
150286.....	180	239877.....	76	556420.....	22, 181
150287.....	180	239887.....	76	556424.....	158, 182
151519.....	178	241234.....	121	556427.....	154, 182
155470.....	183	241485.....	76	556429.....	206
155494.....	183	241486.....	76, 80, 81	556448.....	206
155495.....	183	241572.....	76	556540.....	132, 139, 145
155541.....	183	241573.....	76	556567.....	134, 141, 147
155570.....	183	241623.....	76	556568.....	135, 142, 146
155653.....	183	243159.....	80	556569.....	134, 141, 147, 155
155665.....	183	243170.....	80, 81	556570.....	135, 142, 146
155677.....	184	243191.....	81	556572.....	156, 162
155699.....	177	244023.....	81	556586.....	241
155865.....	183	247443.....	80	556624.....	233
156022.....	180	247444.....	80	556634.....	218
156172.....	183	247450.....	80	556636.....	219
156173.....	183	247538.....	80, 81	556637.....	219
156296.....	178	247540.....	80	556638.....	217, 245
156580.....	180	247574.....	80	556639.....	219
156589.....	184	247575.....	76, 80, 81	556640.....	219
156684.....	183	247700.....	50, 81	556642.....	217
156823.....	22, 183, 204	247701.....	50, 80, 81	556643.....	219
156849.....	178	247702.....	50, 80, 81	556644.....	163, 217, 245
156971.....	178	247703.....	80, 81	556645.....	219
157191.....	178	247704.....	80, 81	556646.....	219
157350.....	178	247706.....	80, 81	556647.....	217
157416.....	184	247707.....	80, 81	556648.....	219
157676.....	184	247886.....	24, 244	556656.....	219
157705.....	183	247902.....	80, 81	556660.....	217, 241, 245
157785.....	183	258262.....	230	556661.....	217
158212.....	179	258263.....	230	556665.....	241
158256.....	183	258299.....	198	556666.....	219
158383.....	183	258348.....	247, 248	556762.....	185
158491.....	178	260067.....	26, 100, 171	556763.....	188
158555.....	178	261840.....	188	556764.....	188
158581.....	179	262205.....	195	556808.....	230
158586.....	179	262206.....	195	556812.....	233
158683.....	177	262208.....	195	556939.....	233
159153.....	183	262210.....	195	556944.....	233
159239.....	178	295607.....	182	556994.....	132
159801.....	184	297085.....	191	556997.....	153
159840.....	180	500352.....	192	557153.....	174
159841.....	179	502033.....	192	557154.....	174
159842.....	180	502820.....	191	557160.....	40
160022.....	183	502851.....	192	557161.....	40
160032.....	178	503086.....	191	557162.....	53
160327.....	183	503931.....	195	557207.....	56, 226
160701.....	178	512351.....	192	557208.....	226

Part No.	Page No.	Part No.	Page No.	Part No.	Page No.
557264	107	557774	156	558318	113
557270	41, 55, 226	557781	26, 69, 70, 100, 125, 171	558321	113
557271	41, 55, 226	557803	173	558322	113
557272	41	557804	173	558323	113
557273	41	557805	173	558633	139
557278	204	557806	173	558794	179
557280	70	557807	173	558795	181
557286	43	557808	173	558799	133, 182
557293	43	557810	43	558881	230
557349	127, 133, 182	557811	173	558906	93, 205
557373	205	557813	44, 45	558910	181
557374	205	557814	44, 45	558938	162
557377	106	557815	44	558941	146
557391	149, 154, 182	557816	44	558949	44
557392	180, 245	557817	44	558950	44
557393	180, 245	557818	44	558951	44
557395	177, 215	557819	44	558953	44
557402	74	557820	44	558954	44
557422	147, 169	557821	43	558955	44
557423	147, 169	557822	43	558956	45
557424	147	557824	231	558968	162
557425	147	557825	43, 69	559037	56, 226
557427	147	557827	231	559307	89
557428	147	557829	70, 203	560381	53, 88, 89
557429	147	557864	70, 93, 94, 204	560384	88
557433	70, 74	557866	70, 204	560387	88
557434	70	557874	205	560388	88
557435	70	557875	205	560389	88
557436	70	557880	205	560390	88
557437	70	557898	241	560392	88
557438	70	557901	241	560528	179
557439	70	557941	244	560530	177
557484	153	557943	107	560531	191, 201
557488	150	557944	107, 205, 212	560532	177
557489	150	557945	107	560533	177
557490	150	557946	107	560534	245
557491	150	557950	219	560540	181
557492	150	557954	177	560541	181
557493	150	557955	180	560542	181
557494	150, 159	557963	219	560543	181
557508	132, 139, 145	557966	242	560576	150
557509	149	557968	206	560583	162
557514	127	557969	206	560591	159
557515	128	557997	45	560592	159
557516	128	557998	45	560593	159
557517	128	558021	162	560594	159
557518	128	558022	162	560595	159
557519	128	558024	162	560596	159
557520	128	558025	162	560597	159
557546	171	558031	105	560600	159
557551	69	558156	112	560601	159
557700	174	558159	112	560602	159
557701	174	558188	112	560603	159
557720	125	558189	112	560604	159
557721	132	558190	112	560605	159
557731	132, 145	558220	112	560620	149
557732	132, 145	558221	230	560643	127
557733	132, 145	558289	55, 226, 232	560645	127
557734	132, 145	558290	55, 226, 232	560701	74
557735	132, 145	558291	55, 226	560734	63
557736	132, 145	558292	55, 226	560919	132, 145
557738	132, 145	558293	55, 226	560920	135
557739	132, 145	558294	55, 226	560936	132
557740	132, 145	558298	204	560943	132
557741	135, 142, 162	558306	113	561028	162
557745	146, 162	558307	113	561029	153
557746	135, 142, 162	558308	113	561067	45
557747	162	558309	113	561101	129
557752	162	558310	113	561102	151, 156
557766	153	558311	113	561131	215
557767	153	558312	113	561132	219
557768	153	558313	113	561133	219
557769	153	558314	113	561134	219
557770	153	558315	113	561140	162
557771	153	558316	113	561370	88
557772	153	558317	113	561371	88

# Index

Part No.	Page No.	Part No.	Page No.	Part No.	Page No.
561430.....	181	562686.....	146	562899.....	41
562500.....	127	562687.....	146	562901.....	69
562501.....	127	562688.....	146	562902.....	40, 69
562502.....	127	562689.....	146	562903.....	40, 69
562503.....	127	562690.....	146	562904.....	69
562504.....	127	562711.....	133	562905.....	69
562505.....	127	562712.....	133	562906.....	69
562508.....	127	562713.....	133	562907.....	65
562509.....	127	562714.....	133	562908.....	41
562510.....	127	562715.....	133	562909.....	69
562511.....	127	562716.....	133	562911.....	69
562514.....	149	562717.....	133	562914.....	128
562515.....	149	562718.....	133	562915.....	128
562516.....	149	562720.....	133	562916.....	150
562517.....	149	562721.....	133	562917.....	150
562518.....	149	562722.....	133	562918.....	229
562519.....	149	562723.....	133	562919.....	229
562520.....	149	562724.....	133	562925.....	230
562521.....	149	562725.....	133	562926.....	230
562522.....	149	562726.....	133	562927.....	230
562523.....	149	562727.....	133	562928.....	230
562524.....	149	562729.....	133	562929.....	230
562525.....	149	562730.....	133	562951.....	229
562526.....	149	562731.....	133	562952.....	230
562527.....	149	562732.....	133	562994.....	163, 165
562528.....	149	562733.....	133	562995.....	217
562529.....	149	562739.....	133	563005.....	89
562530.....	149	562740.....	133	563013.....	56, 89, 226
562531.....	149	562741.....	133	563014.....	65, 69
562532.....	149	562742.....	133	563015.....	40, 41, 65, 69, 86
562533.....	149	562743.....	133	563016.....	40, 41, 65, 69, 86
562534.....	149	562755.....	140	563020.....	230
562535.....	149	562756.....	140	563024.....	230
562536.....	149	562757.....	140	563030.....	233
562538.....	149	562758.....	140	563032.....	233
562539.....	149	562759.....	140	563041.....	233
562540.....	149	562760.....	140	563042.....	233
562541.....	149	562813.....	154	563043.....	233
562542.....	149	562814.....	154	563044.....	233
562543.....	149	562815.....	154	563046.....	199
562545.....	149	562816.....	154	563048.....	199, 200
562546.....	149	562817.....	154	563052.....	199
562569.....	149	562818.....	154	563053.....	70
562570.....	158	562819.....	154	563054.....	198
562571.....	158	562820.....	154	563055.....	198
562572.....	158	562821.....	154	563056.....	70
562573.....	158	562822.....	154	563057.....	198
562574.....	158	562823.....	154	563058.....	202
562575.....	158	562824.....	154	563060.....	199
562576.....	158	562825.....	154	563061.....	199
562577.....	158	562826.....	154	563068.....	172
562578.....	158	562827.....	154	563069.....	172
562579.....	158	562828.....	154	563070.....	172
562580.....	158	562829.....	154	563072.....	74
562581.....	158	562830.....	154	563073.....	173
562582.....	158	562831.....	154	563074.....	136, 173
562583.....	158	562832.....	154	563075.....	172
562584.....	158	562833.....	154	563076.....	172
562585.....	158	562834.....	154	563077.....	172
562647.....	198	562854.....	74	563078.....	172
562649.....	198	562855.....	74	563079.....	172
562653.....	125	562872.....	105	563080.....	172
562654.....	125	562884.....	69, 94	563093.....	173
562655.....	125	562885.....	69	563095.....	173
562656.....	125	562886.....	69	563096.....	173
562657.....	125	562887.....	69	563097.....	173
562658.....	125	562888.....	69	563100.....	173
562659.....	125	562889.....	69	563101.....	228
562660.....	133	562890.....	69	563102.....	174
562679.....	146	562891.....	69	563103.....	174
562680.....	146	562892.....	41, 65	563111.....	230
562681.....	146	562893.....	41, 65	563113.....	229
562682.....	146	562895.....	41	563120.....	53
562683.....	146	562896.....	41, 65	563121.....	53
562684.....	146	562897.....	41	563122.....	53
562685.....	146	562898.....	41	563129.....	165

Part No.	Page No.	Part No.	Page No.	Part No.	Page No.
563146	176	563241	151, 167	563425	132, 145
563147	176	563242	151, 167	563447	132
563148	176	563243	151, 167	563451	132
563149	176	563244	151, 167	563456	136
563150	176	563245	151, 167	563461	136
563153	175	563251	135, 142, 146, 171	563465	135
563154	175	563252	134, 155, 167	563469	133
563156	22, 151, 168	563253	134, 155, 167	563470	133
563157	22, 151, 168	563254	134, 155, 167	563471	133
563158	22, 151, 168	563255	134, 155, 167	563472	133
563159	22, 151, 168	563256	134, 155, 167	563476	150, 156, 162
563160	22, 93, 151, 168	563257	134, 155, 167	563479	173
563161	22, 151, 168	563258	134, 147, 155, 167	563480	173
563162	168	563260	150, 156, 171	563495	162
563163	129	563261	134, 147, 155	563502	234
563164	129, 168	563262	147	563503	234
563166	129, 168	563263	134, 147	563504	234
563167	129, 168	563269	159, 171	563505	234
563168	168	563270	125, 171	563506	234
563169	168	563271	125, 171	563507	174
563170	134, 155, 168	563272	69, 72, 128, 135, 150, 156, 171	563508	174
563171	134, 155, 168	563273	128, 135, 150, 156, 171	563509	174
563172	134, 155, 168	563275	165	563510	174
563173	134, 155, 168	563276	165	563511	174
563174	134, 155, 168	563277	159	563512	174
563175	134, 155, 168	563278	159	563515	174
563176	134, 155, 168	563279	132, 145	563516	174
563178	180	563287	149	563518	153
563179	39, 41, 70, 85, 170	563304	67	563519	153
563180	70	563305	78	563520	153
563182	170	563306	67	563521	153
563183	170	563307	78	563522	153
563184	39, 41, 85, 170	563308	67	563524	154
563185	170	563315	65, 70, 72	563525	154
563186	70, 170	563316	40, 41, 69, 86	563526	154
563187	170	563317	40, 41, 69, 86	563527	153
563188	170	563318	69	563555	125
563191	170	563319	56, 69	563557	45
563192	170	563320	56, 69	563558	43
563193	170	563321	56, 69	563565	231
563194	170	563322	39, 41, 65, 69, 72, 85	563566	231
563195	197	563323	68	563571	65
563196	197	563324	68	563572	65
563197	197	563325	70	563573	65
563198	197	563326	70	563574	65
563199	197	563327	70	563575	65
563200	197	563328	70, 203	563576	65
563201	197	563329	68	563577	65
563203	201	563330	68	563578	65
563205	201	563331	68	563579	65
563206	197	563332	65, 70, 72	563580	94
563207	70, 197	563333	68	563589	247
563210	197	563336	68	563590	247
563211	70, 197	563337	70	563593	247
563212	175	563345	78	563625	247
563213	175	563358	72	563644	247, 248
563214	175	563360	72	563645	247, 248
563215	175	563363	72	563646	247, 248
563221	147, 169	563364	72	563647	248
563222	147, 169	563365	72	563648	247, 248
563223	169	563367	72	563654	247, 248
563224	147, 169	563368	72	563655	247, 248
563225	169	563370	72	563706	247, 248
563226	147, 169	563372	72	563727	248
563228	169	563380	40, 41	563728	247, 248
563229	147, 169	563383	41, 86	563762	65
563230	235	563384	39, 41, 85	563769	241
563231	129, 167	563385	39, 41, 85	563770	107, 206
563232	129, 167	563386	41	563776	206, 217
563233	129, 167	563387	41	563783	216
563234	129, 167	563388	41	563786	215
563235	129, 167	563389	41	563788	216
563236	129, 167	563393	93	563789	216, 240
563237	167	563421	132, 145	563796	216, 240
563239	151, 167	563422	132	563814	247
563240	151, 167	563424	132, 145	563854	247, 248

# Index

Part No.	Page No.	Part No.	Page No.	Part No.	Page No.
563856.....	248	564264.....	69	2000640.....	14
563857.....	248	564269.....	69	2000641.....	14
563858.....	247, 248	564270.....	69	2000643.....	14
563859.....	248	564271.....	69	2000644.....	14
563860.....	248	564276.....	230	2000645.....	14
563862.....	248	564277.....	230	2000646.....	14
563874.....	247	564278.....	230	2000647.....	14
563888.....	247	564279.....	230	2000648.....	14
563902.....	67	564280.....	230	2000649.....	14
563903.....	67	564282.....	230	2000650.....	14
563904.....	67	564283.....	230	2000651.....	14
563905.....	78	564290.....	88	2001401.....	28
563906.....	78	564318.....	39, 41, 85	2002240.....	32
563909.....	72	564322.....	69	2002241.....	32
563911.....	235	564332.....	228	2002243.....	32
563912.....	74	564336.....	229, 230	2002244.....	32
563913.....	74	564342.....	173	2002247.....	32
563915.....	40	564343.....	173	2002248.....	32
563916.....	40	564349.....	175	2002258.....	32
563917.....	149, 153	564350.....	175	2002295.....	24
563918.....	231	564351.....	175	2002296.....	24
563919.....	231	564355.....	169	2002702.....	32
563920.....	231	564356.....	125, 171	2004436.....	15
563921.....	40	564357.....	128, 135, 150, 156, 171	2004439.....	15
563924.....	93	564377.....	39, 41, 85	2004441.....	15
563925.....	78	564399.....	150, 156, 162	2004443.....	15
563926.....	158	564402.....	159, 162	2004445.....	15
563929.....	132	564406.....	174	2004446.....	15
563934.....	69	564411.....	45	2004447.....	15
563945.....	72	564412.....	43	2004545.....	32
563948.....	127	564413.....	43	2004626.....	32
563954.....	170	564414.....	43	2004968.....	32
563955.....	170	564415.....	43	2006075.....	210
563956.....	170	567251.....	133, 135, 146, 182	2006225.....	32
563957.....	170	571026.....	21	2006886.....	32
563959.....	170	571028.....	22	2006887.....	32
563960.....	170	571030.....	23	2007096.....	22, 23, 37, 39, 41, 85, 204
563961.....	170	571031.....	23	2008155.....	22, 204
563962.....	39, 70, 74, 85, 170	571032.....	23	2008771.....	215
563963.....	70, 170	571033.....	23	2008943.....	28
563964.....	70, 170	571036.....	23, 37	2008944.....	28
563965.....	39, 70, 85, 170	571039.....	106	2008945.....	28
563966.....	70, 170	571040.....	106	2009010.....	190
563970.....	159, 162	571041.....	20, 21, 37	2009011.....	190
563984.....	216	571058.....	22	2010651.....	203
563994.....	216	571063.....	21	C19005.....	184
564015.....	56, 89, 226	571064.....	24	C19466.....	180
564019.....	112	571070.....	22	C19491.....	180
564020.....	112	571071.....	22	C19660.....	179
564021.....	112	571155.....	21	C19681.....	179
564022.....	112	571156.....	21	C19685.....	179
564024.....	112	571157.....	21	C20461.....	178
564025.....	112	571158.....	21	C20465.....	178
564034.....	112	571159.....	23, 37	C20477.....	178
564054.....	53	571162.....	24	C20485.....	178
564055.....	53	571167.....	24	C20487.....	178
564058.....	56, 226	571172.....	28	C20489.....	178
564059.....	170	571182.....	21	C20490.....	178
564086.....	215	571255.....	23, 37	C20686.....	188
564090.....	216, 240	571286.....	20, 21, 37	C20694.....	188
564151.....	229	571287.....	20, 21	C20708.....	186
564166.....	53, 88, 89	571288.....	20, 21	C20768.....	186
564167.....	53, 88, 89	571289.....	20, 21	C38324.....	177
564168.....	88	2000047.....	15	LM1111.....	85
564170.....	53, 88, 89	2000534.....	15	LM1115.....	85
564171.....	88	2000535.....	15	LM1211.....	85
564172.....	88	2000536.....	15	LM1215.....	85
564173.....	88	2000537.....	15	LM2536.....	39
564174.....	88	2000538.....	15	LM4211.....	85
564178.....	88	2000539.....	15	LM4215.....	85
564179.....	53, 88, 89	2000634.....	14	LM4333.....	39
564182.....	88	2000635.....	14	LM5111.....	85
564186.....	88	2000636.....	14	LM5114.....	85
564194.....	248	2000637.....	14	LM5211.....	85
564196.....	88	2000638.....	14	LM5214.....	85
564200.....	160, 167	2000639.....	14	LM6211.....	85

# Index

Part No.	Page No.	Part No.	Page No.	Part No.	Page No.
LM6214	85	MBFOAE	88, 224		
LM6334	39	MBFOAF	88		
LM6544	39	MBGOAA	88, 224		
LM6611	39	MBGOAB	88		
LM7211	85	MBGOAE	88, 224		
LM7214	85	MBGOAF	88		
LM7311	39	MBHOAA	88, 224		
LM7354	39	MBHOAB	88		
LM7534	39	MBHOAE	88, 224		
LM8111	85	MBHOAF	88		
LM8114	85	MBJOAJ	224		
LM8211	85	MBJOAK	53, 224		
LM8214	85	MBJOAL	53, 224		
LM8534	39	MBJOAM	53, 224		
LM8544	39	MBJOAN	224		
LM9511	39	MBKOAJ	224		
LM9521	39	MBKOAK	53, 224		
M MBA0AA	88, 224	MBKOAL	53, 224		
MBA0AB	88, 224	MBKOAM	53, 224		
MBA0AC	88, 224	MBKOAN	53, 224		
MBA0AD	88, 224	MBLOAJ	224		
MBA0AE	88, 224	MBLOAK	53, 224		
MBA0AF	88, 224	MBLOAL	53, 224		
MBA0AG	88, 224	MBLOAM	53, 224		
MBA0AH	88, 224	MBLOAN	53, 224		
MBA0AJ	89, 224	MBMOAJ	224		
MBA0AK	89, 224	MBMOAK	53, 224		
MBA0AL	89, 224	MBMOAL	53, 224		
MBA0AM	89, 224	MBMOAM	53, 224		
MBA0AN	89, 224	MBMOAN	53, 224		
MBB0AA	88, 224	MBNOAJ	224		
MBB0AB	88, 224	MBNOAK	53, 224		
MBB0AC	88, 224	MBNOAL	53, 224		
MBB0AD	88, 224	MBNOAM	53, 224		
MBB0AE	88, 224	MBNOAN	53, 224		
MBB0AF	88, 224	MBPOAY	53, 224		
MBB0AG	88, 224	MBROAY	53, 224		
MBB0AH	88, 224	MBSOAY	53, 224		
MBB0AJ	89, 224	MM1112	43		
MBB0AK	89, 224	MM1113	43		
MBB0AL	89, 224	MM1212	43		
MBB0AM	89, 224	MM1412	43		
MBB0AN	89, 224	MM2112	43		
MBC0AA	88, 224	MM2212	43		
MBC0AB	88	MM2412	43		
MBC0AC	88	MM3212	43		
MBC0AD	88	MM3412	43		
MBC0AE	88, 224	U70015	181		
MBC0AF	88	U70234	191		
MBC0AG	88	U70588	194		
MBC0AH	88	U70933	195		
MBC0AJ	89, 224				
MBC0AK	89, 224				
MBC0AL	89, 224				
MBC0AM	89, 224				
MBC0AN	89, 224				
MBD0AA	88, 224				
MBD0AB	88				
MBD0AE	88, 224				
MBD0AF	88				
MBD0AJ	89, 224				
MBD0AK	89, 224				
MBD0AL	89, 224				
MBD0AM	89, 224				
MBD0AN	89, 224				
MBE0AA	88, 224				
MBE0AB	88				
MBE0AE	88, 224				
MBE0AF	88				
MBE0AJ	89, 224				
MBE0AK	89, 224				
MBE0AL	89, 224				
MBE0AM	89, 224				
MBE0AN	89, 224				
MBFOAA	88, 224				
MBFOAB	88				



**For more information visit [graco.com](http://graco.com)**

©2025 Graco Inc. 340821 Rev. AQ 5/25 All other brand names or marks are used for identification purposes and are trademarks of their respective owners. All written and visual data contained in this document are based on the latest product information available at the time of publication. Graco reserves the right to make changes at any time without notice. For more information on Graco's intellectual property, see [www.graco.com/patent](http://www.graco.com/patent) or [www.graco.com/trademarks](http://www.graco.com/trademarks).