



COOPER FLUID SYSTEMS

Local Solutions. National Strength.

Single Line Lubrication Systems

PARTS QUICK REFERENCE GUIDE



CooperBuilt Systems

AUSTRALIA WIDE

1300 026 673

www.cooperfluidsystems.com.au

Contents

Lubrication System Layout (Typical)	3
CooperBuilt Grease Pump Stations	4
Flowmaster 24V DC Grease Pump Station	4
Hi Chief Hydraulic Grease Pump Station	5
Grease Pump Stations (Spare Parts)	6
CFS LUBE OM 3 Grease Vent Valve Assembly	6
Grease Pressure Switches	7
Pressure Gauges	8
Vent Valves: Remote Mount	9
Lubrication System Controllers	10
Injectors & Manifolds	12
Injector Manifolds	12
Injectors: SL-1	13
Injectors: SL-11	13
Injectors: SLV and SLV-XL	14
Injectors: SL-32	15
Injectors: SL-32HV	15
Injectors: SL-6	16
Grease Pumps (Bare)	17
Hi Chief Hydraulic	17
Flowmaster Hydraulic	18
Flowmaster 24V DC Electric	19
Pneumatic 20-Series	20
Grease Tanks	21
Grease Fill Shut off Valves	22
Grease Fill Point Manifolds	24
Repair Parts GFDK-01-001	24
Grease Filters	25
Grease Steel Tubing - Heavy Wall	25

Lubrication System Layout (Typical)

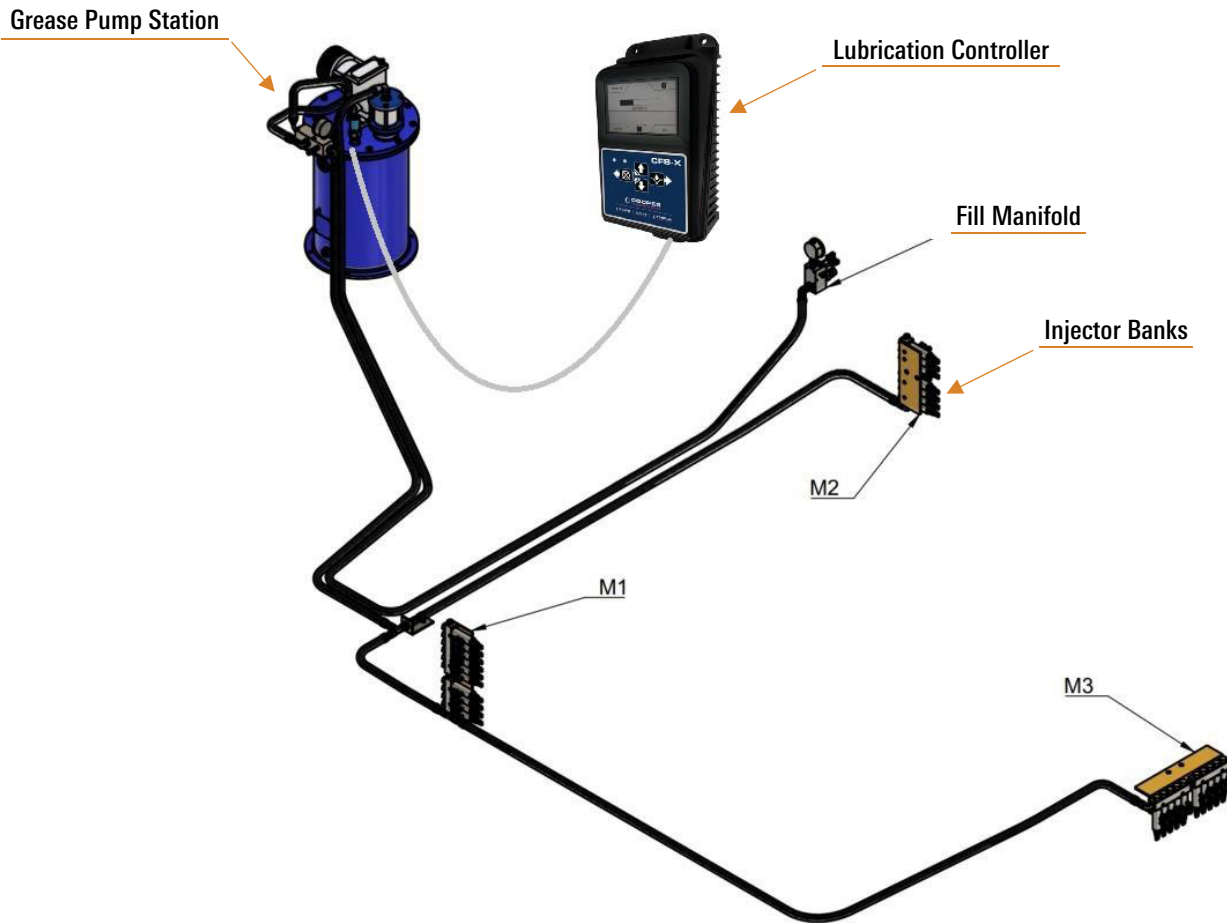

This parts manual is intended as a quickreference guide to identify the major components in a SingleLine (injector-based) grease system.

For further information and resources, please contact your nearest Cooper Fluid Systems branch
Technical & Repair Manuals.
Spare Parts.
Operating Instructions.
Service and Repair



CooperFluidSystems.com.au

A PROUD DIVISION OF  Coventry Group Ltd

1300 026 673 | ABN 37 008 670 102

Cooper Fluid Systems is a national leader in hydraulics, lubrication, fluid dispensing, automation, refuelling, and industrial hose solutions. Operating for over 50 years with 15 branches across Australia, we provide end-to-end solutions – from design and manufacture to installation and maintenance – backed by the strength of Coventry Group Ltd. We proudly support industries including mining, defence, agriculture, construction, manufacturing, and recycling.

CooperBuilt Grease Pump Stations

Flowmaster 24V DC Grease Pump Station

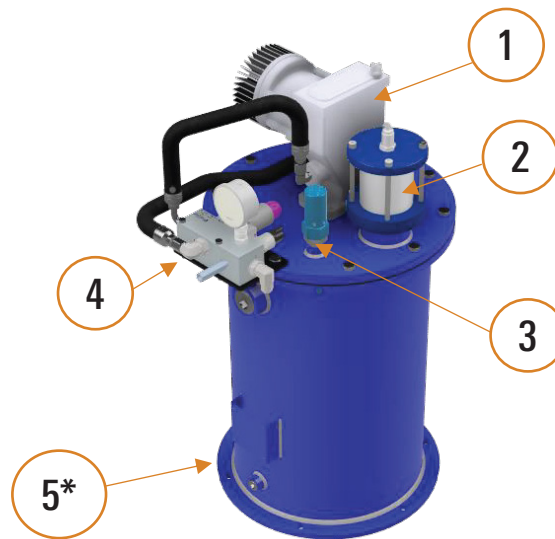

Refer to the individual parts manuals for further details on each component.

Item #	Description	Part Number / Notes
1	Grease Pump, Flowmaster II (485mm / 20kg leg)	01-085737
2	Grease Fill Shutoff Valve	V96
3	Tank breather / Safety Relief (25 psi)	BRV25-08
4	Outlet Manifold / Vent Valve Assembly	CFS-LUBE-OM-3
5*	See Reservoir Sizes Listed Below	
5a	Reservoir 17Ltr AS1210 rated vessel	CAN17
5b	Reservoir 25Ltr (non AS1210 rated)	CAN25
5c	Reservoir 35Ltr (non AS1210 rated)	CAN35
5d	Reservoir 37Ltr AS1210 rated vessel	CAN37

Item #	Description	Part Number / Notes
1	Grease Pump, Flowmaster II (700mm / 60kg leg)	01-085738
2	Grease Fill Shutoff Valve	V96
3	Tank breather / Safety Relief (25 psi)	BRV25-08
4	Outlet Manifold / Vent Valve Assembly	CFS-LUBE-OM-3
5*	Reservoir 57Ltr AS1210 rated vessel	CAN54

Item #	Description	Part Number / Notes
1	Grease Pump, Flowmaster II (865mm / 180kg leg)	01-085739
2	Grease Fill Shutoff Valve	V96
3	Tank breather / Safety Relief (25 psi)	BRV25-08
4	Outlet Manifold / Vent Valve Assembly	CFS-LUBE-OM-3
5*	See Reservoir Sizes Listed Below	
5a	Reservoir 68Ltr AS1210 rated vessel	CAN68
5b	Reservoir 255Ltr (non AS1210 rated)	CAN255

Hi-Chief Hydraulic Grease Pump Station

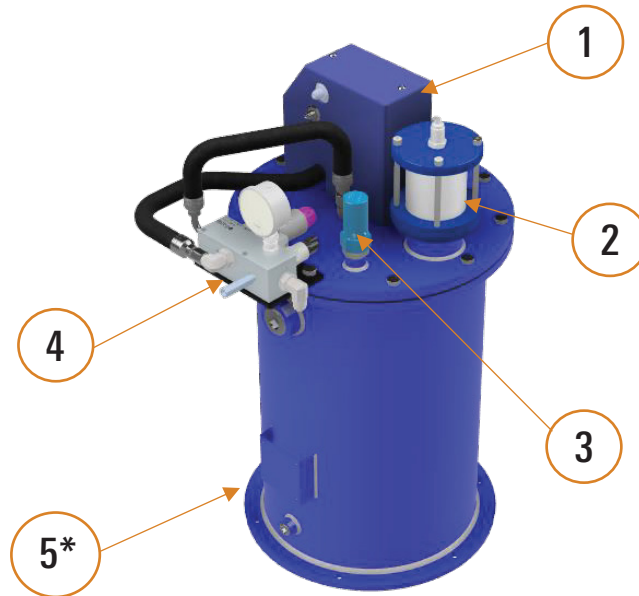

Refer to the individual parts manuals for further details on each component.

Item #	Description	Part Number / Notes
1	Grease Pump, HiChief (480mm / 20kg leg)	03-000920
2	Grease Fill Shutoff Valve	V96
3	Tank breather / Safety Relief (25 psi)	BRV25-08
4	Outlet Manifold / Vent Valve Assembly	CFS-LUBE-OM-3
5*	See Reservoir Sizes Listed Below	
5a	Reservoir 17Ltr AS1210 rated vessel	CAN17
5b	Reservoir 25Ltr (non AS1210 rated)	CAN25
5c	Reservoir 35Ltr (non AS1210 rated)	CAN35
5d	Reservoir 37Ltr AS1210 rated vessel	CAN37

Item #	Description	Part Number / Notes
1	Grease Pump, HiChief (695mm / 60kg leg)	03-000950USA
2	Grease Fill Shutoff Valve	V96
3	Tank breather / Safety Relief (25 psi)	BRV25-08
4	Outlet Manifold / Vent Valve Assembly	CFS-LUBE-OM-3
5*	Reservoir 57Ltr AS1210 rated vessel	CAN54

Item #	Description	Part Number / Notes
1	Grease Pump, HiChief (865mm / 180kg leg)	03-000954
2	Grease Fill Shutoff Valve	V96
3	Tank breather / Safety Relief (25 psi)	BRV25-08
4	Outlet Manifold / Vent Valve Assembly	CFS-LUBE-OM-3
5*	See Reservoir Sizes Listed Below	
5a	Reservoir 68Ltr AS1210 rated vessel	CAN68
5b	Reservoir 255Ltr (non AS1210 rated)	CAN255

Grease Pump Stations (Spare Parts)

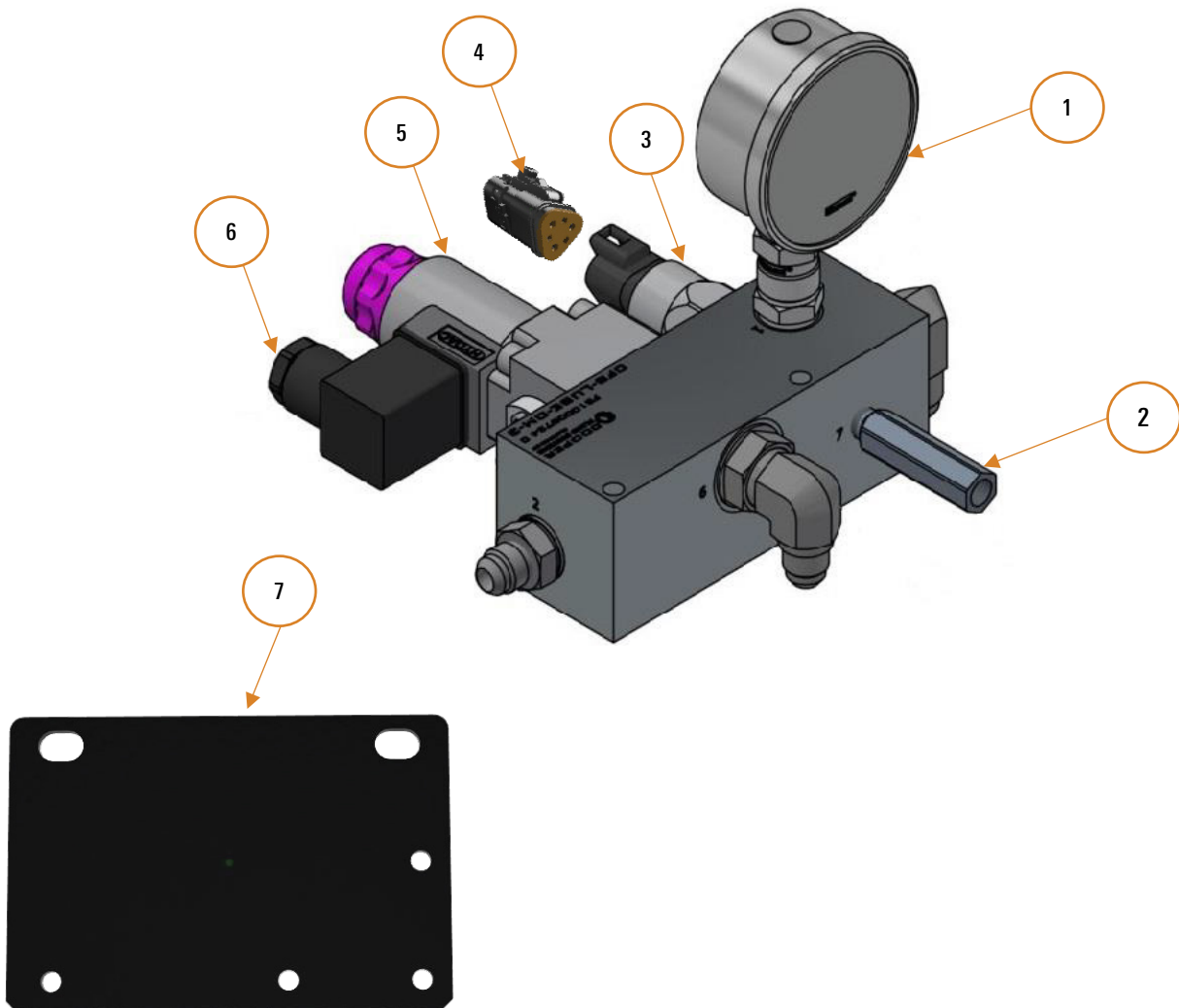

CFS-LUBE-OM-3 Grease Vent Valve Assembly





Item #	Description	Part Number / Notes
1	Grease Pressure Gauge 315bar	GPG63-315
2	Grease Safety Relief Valve 4000psi	01-090942
3	Grease Pressure Switch – preset @ 3000psi	CFS-GPS
4	DT Connector 3pin	CMP-DT3-F
5	Valve 2/2 24V N.O.	4002624
6	Electrical Connector DIN	710775
7	Mounting Bracket Suits CFS CAN17/37/54	MB-OM2VENT

The CFS-LUBE-OM-3 valve supersedes the previous version CFS-LUBE-OM-2, which is now obsolete. If parts are required for an earlier version OM-2 it should be replaced as a complete assembly.

Grease Pressure Switches

Images	Part Number	Information
	CFS-GPS	Grease Pressure Switch Range: Preset @ 3000psi Connection: 1/4" BSPP Male Electrical Plug Included: YES
	CMP-DT3F	Electrical Connector 3-pin

Images	Part Number	Information
	03-XMLA300D2C11	Grease Pressure Switch Range: Adjustable 0300bar Connection: 1/4" BSPP Female Electrical Plug Included: NO
	640006	Electrical Connector DIN 4-pin

Images	Part Number	Information
	PSP300R14SM	Grease pressure switch Range: Adjustable 0-300bar Connection: 1/4" BSPP Male Electrical Plug Included: YES

Pressure Gauges

Images	Part Number	Information
	<p style="text-align: center;">GPG63-315</p>	<p>GREASE Pressure Gauge 63mm Brand: CooperBuilt Connection: 1/4" BSPT Male (bot) Range: 315bar / 4500 psi (for grease output side of pump)</p>
	<p style="text-align: center;">OPG63-100</p>	<p>OIL Pressure Gauge 63mm Brand: CooperBuilt Connection: 1/4" BSPT Male (bot) Range: 100bar / 1450 psi (for hydraulic input circuit to pump)</p>
 <p data-bbox="204 1346 456 1373">Image for reference only.</p>	<p style="text-align: center;">G36-P10-01-X30</p>	<p>AIR Pressure Gauge 36mm Brand: SMC Connection: 1/8" BSPT Male (rear) Range: 145 PSI / 1mPa (CAT 785 / 789 pneumatic grease pump)</p>

Vent Valves: Remote Mount

Images	Part Number	Information
	02-525-32083-1	<p>Grease Vent Valve – 2/2 24V DC</p> <p>Brand: SKF</p> <p>Connection: 1/2" BSPP Female (Includes manifold)</p> <p><i>Can substitute: VP1S-1/2-N24</i></p>
	VP1S-1/2-N24	<p>Grease Vent Valve – 2/2 24V DC</p> <p>Brand: HAWE</p> <p>Connection: 1/2" BSPP Female (Includes manifold)</p> <p><i>Can substitute: 02-525-32083-1</i></p>
	01-278931	<p>Grease Vent Valve – 2/2 24V DC</p> <p>Brand: SKF</p> <p>Connection: 3/4" NPT Female (Suits CAT Flowmaster Pumps)</p>
	01-084980	<p>Hydraulic Vent Valve</p> <p>Brand: SKF</p> <p>Connection: 3/4" NPT Female (suits CAT hydraulic pumps)</p>
	01-083948	<p>Pneumatic Vent Valve</p> <p>Brand: SKF</p> <p>Connection: 3/4" NPT Female (suits CAT pneumatic pumps)</p>
	MB-FM2VENT	<p>Mounting Bracket</p> <p>Fits CAN17/37/54 to these vents:</p> <p>01-083948, 01-84980 01-278931</p>

Lubrication System Controllers

All controllers below can be used on injector-based grease systems. Where a pulsed output is required (e.g. to power a reciprocating hydraulic motor) the CFS-X or TC100D2C are suitable.

Images	Part Number	Information
	CFS-X	Lubrication Controller 24V DC Brand: CooperBuilt Audible Alarm: YES Pulsed output: YES App Connectivity: YES Level Sensor: YES
	CFS-GH	CFS-X 300mm Cross-over Harness AMP TE14 plug to DTK08
	CFS-GH-KIT	CFS-X 8metre Harness AMP TE14 plug to 8m fly lead
	FS10028347 (was MB-CFSX-001)	Mounting Bracket Universal CFS-X 1x M10 hole, 2x M6 holes
	FS10028332 (was MB-CFSX-002)	Conversion Bracket TC100D2C bolt pattern to CFS-X (when replacing a TC100D2C)

Images	Part Number	Information
	<p style="text-align: center;">TC100D2C</p>	<p>Lubrication Controller 24V DC</p> <p>Brand: CooperBuilt</p> <p>Audible Alarm: YES</p> <p>Pulsed output: YES</p>
	<p style="text-align: center;">01-085307</p>	<p>Lubrication Controller 24V DC</p> <p>Brand: SKF</p> <p>Audible Alarm: YES</p> <p>Pulsed Output: NO</p>
	<p style="text-align: center;">13-002002-1</p> <p style="text-align: center;"><i>(obsolete – replaced by 01-085307)</i></p>	<p>Lubrication Controller 24V DC</p> <p>Brand: JSG (Ultraflow)</p> <p>Audible Alarm: YES</p> <p>Pulsed Output: NO</p>

Injectors & Manifolds

Injector Manifolds

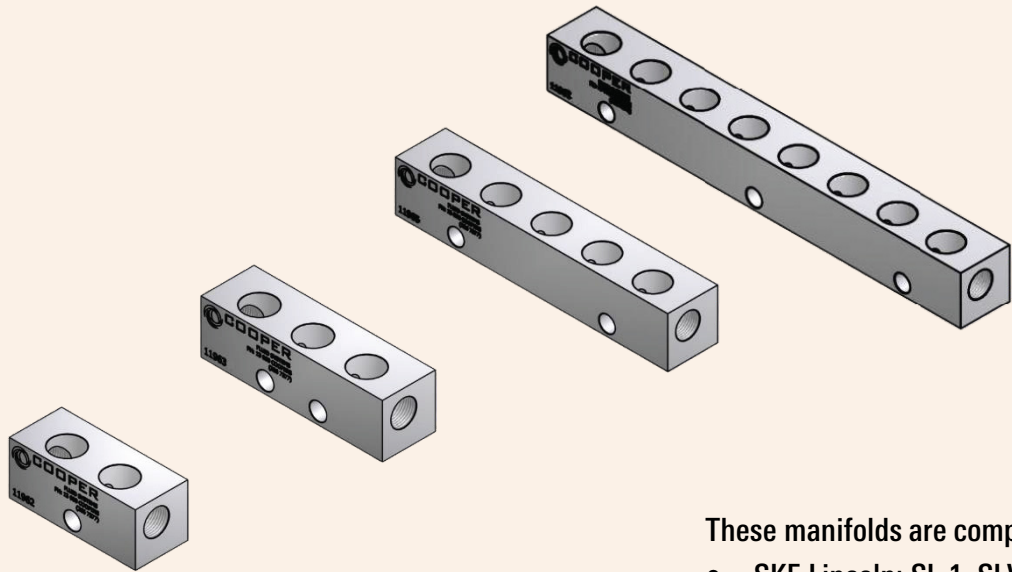





These manifolds are compatible with:



- SKF Lincoln: SL-1, SLV, SLV-XL, SL6
- Graco: GL-1, GL1-X, GL1-XL

Part Number	Information
01-012658	Bare Manifold for 1x Injector
11962	Bare Manifold for 2x Injectors
11963	Bare Manifold for 3x Injectors
11964	Bare Manifold for 4x Injectors
11965	Bare Manifold for 5x Injectors
11966	Bare Manifold for 6x Injectors
11967	Bare Manifold for 7x Injectors
11968	Bare Manifold for 8x Injectors
119610	Bare Manifold for 10x Injectors

Injectors: SL-1

Images	Part Number	Information
	01-081713A	Model: SL-1 Connection: Manifold Mount Priming Nipple Included: YES Dust Cover Included: NO
	01-090471	Priming Nipple
	03-000100	Vinyl Dust Cover SL-1
	01-081646	Cross port Tube SL-1





Injectors: SL-11

Images	Part Number	Information
	01-085497	Model: SL-11 Connection: 1/2" NPTF Priming Nipple Included: YES Dust Cover Included: NO
	01-090471	Priming Nipple
	01-083730	Vinyl Dust Cover SL-11





Injectors: SLV and SLV-XL

Images	Part Number	Information	
	01-085771	Model: SLV Connection: Manifold Mount Priming Nipple Included: YES Dust Cover Included: YES	
	01-085781	Model: SLV-XL (high volume) Connection: Manifold Mount Priming Nipple Included: YES Dust Cover Included: YES	
	01-090471	Priming Nipple, suit SLV & XL	
	01-273088	Poly Carbonate Dust Cover for SLV	
	01-273089	Poly Carbonate Dust Cover for SLV-XL	
	01-081646	Cross port Tube for SLV & XL	
 Adjustment Sleeves	01-085781-1	RED	0.50cc
	01-085781-2	SILVER	0.75cc
	01-085781-3	GOLD	1.00cc
	01-085781-4	GREEN	1.25cc
	01-085781-5	BLACK	1.88cc
	01-085781-6	PURPLE	2.50cc
	01-085781-7	BLUE	3.13cc
	01-085781-8	ORANGE	3.75cc
	01-085781-9	BROWN	4.38cc
	01-085781-10	YELLOW	5.00cc

Injectors: SL-32

Images	Part Number	Information
	01-083337	Model: SL-32 Connection: Manifold Mount Dust Cover Included: NO
	01-083336-1	Injector & Manifold 1bank
	01-083336-2	Injector & Manifold 2bank
	01-083336-3	Injector & Manifold 3bank
	01-083336-4	Injector & Manifold 4bank
	01-068483A	Protection Cap SL-32
	01-014988	Outlet adaptor 1/8" NPTF

Injectors: SL-32HV

Images	Part Number	Information
	01-083338	Model: SL-32HV Connection: Manifold Mount Dust Cover Included: NO
	01- 083336HV-1	Injector & Manifold 1-bank
	01- 083336HV-2	Injector & Manifold 2-bank
	01- 083336HV-3	Injector & Manifold 3-bank
	01- 083336HV-4	Injector & Manifold 4-bank
	01- 083336HV-5	Injector & Manifold 5-bank
	01- 083336HV-6	Injector & Manifold 6-bank
	01- 083336HV-7	Injector & Manifold 7-bank
	01- 083336HV-8	Injector & Manifold 8-bank
	01- 083336HV-9	Injector & Manifold 9-bank
	01- 083336HV-10	Injector & Manifold 10-bank
	01-068483A	Protection Cap SL-32HV
	01-014988	Outlet adaptor 1/8" NPTF

Injectors: SL-6

Images	Part Number	Information	
	01-085881	Model: SL- 6 Connection: Manifold Mount Dust Cover Included: YES Priming Nipple Included: YES	
	01- 279902	Poly Carbonate Dust Cover SL-6	
	01-090471	Priming Nipple	
 <p style="color: #d95319;">Adjustment Sleeves</p>	01-085901-1	RED	0.50cc
	01-085901-2	SILVER	0.75cc
	01-085901-3	GOLD	1.00cc
	01-085901-4	GREEN	1.25cc
	01-085901-5	BLACK	1.85cc
	01-085901-6	PURPLE	2.50cc
	01-085901-7	BLUE	3.13cc
	01-085901-8	ORANGE	3.75cc
	01-085901-9	BROWN	4.38cc
	01-085901-10	YELLOW	5.00cc

Grease Pumps (Bare)

Hi-Chief Hydraulic

JSG HiChief	Part Number	Information
	03-000964	Model: JSG Hi-Chief Hydraulic Size: USA 5 Gallon (Stubby) Suits: Compact Pump Station
	03-000920	Model: JSG Hi-Chief Hydraulic Size: 20kg leg (60lb) Suits: CFS CAN17 to CAN37
	03-000954	Model: JSG Hi-Chief Hydraulic Size: 180kg leg (200lb) Suits: CFS CAN68, CAN255
	03-000014-2	Reciprocating timer for Hi-Chief 2 sec on / 2 sec off

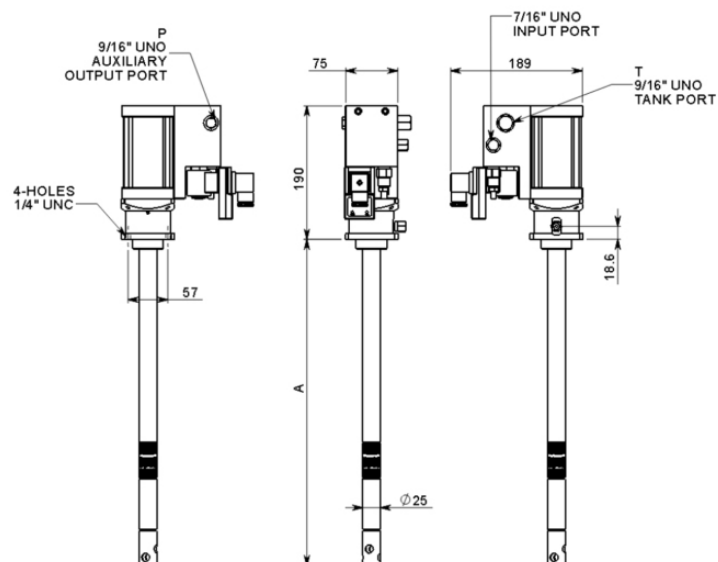

Model	A Length (mm)
03-000964	350
03-000920	480
03-000954	865

Flowmaster Hydraulic

SKF Flowmaster II	Part Number	Information
	01-085732	Model: Hydraulic Flowmaster II Size: 20kg leg (60lb) Suits: CFS CAN17, CAN37
	01-085733	Model: Hydraulic Flowmaster II Size: 60kg leg (120lb) Suits: CFS CAN54
	01-085734	Model: Hydraulic Flowmaster II Size: 180kg leg (400lb) Suits: CFS CAN68, CAN255

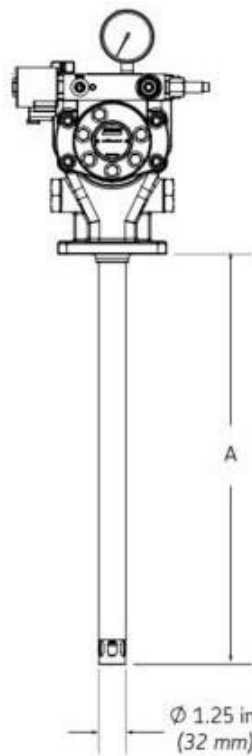

Model	A Length (mm)
01-085732	484
01-085733	700
01-085743	865

Flowmaster 24V DC Electric

SKF Flowmaster II	Part Number	Information
	01-085736	Model: 24V DC Flowmaster II Size: USA 5 Gallon (Stubby) Suits: CAT 16M Factory Grease Tank
	01-085737	Model: 24V DC Flowmaster II Size: 20kg leg (60lb) Suits: CFS CAN17, CAN25, CAN37
	01-085738	Model: 24V DC Flowmaster II Size: 60kg leg (120lb) Suits: CFS CAN54
	01-085739	Model: 24V DC Flowmaster II Size: 180kg leg (400lb) Suits: CFS CAN68, CAN255

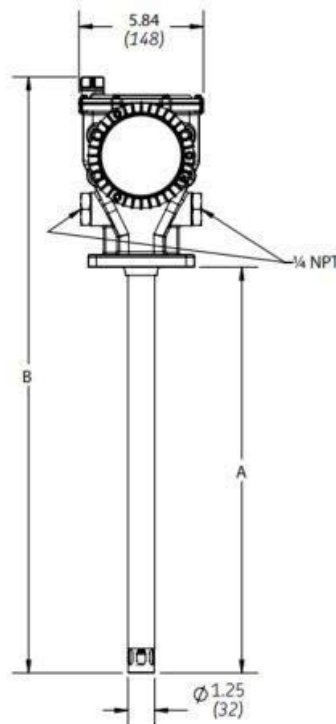

Model	A Length (mm)
01-085736	350
01-085737	485
01-085738	700
01-085739	865

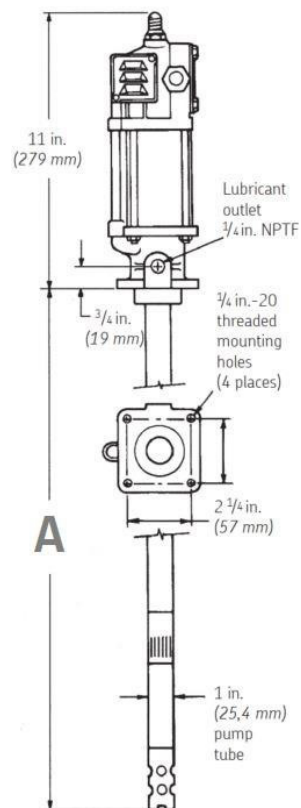

Pneumatic 20-Series

SKF 20 Series	Part Number	Information
	01-083513	Model: Pneumatic 20 series 50:1 Size: 20kg leg (60lb) Suits: CFS CAN17, CAN37
	01-082050	Model: Pneumatic 20 series 50:1 Size: 60kg leg (120lb) Suits: CFS CAN54
	01-082054	Model: Pneumatic 20 series 50:1 Size: 180kg leg (400lb) Suits: CFS CAN68, CAN255





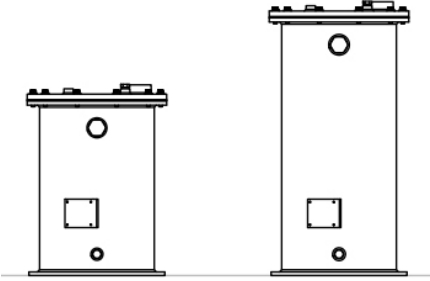

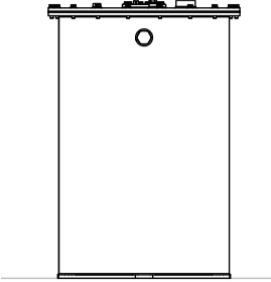

Model	A Length (mm)
01-083513	480
01-082050	485
01-082054	860

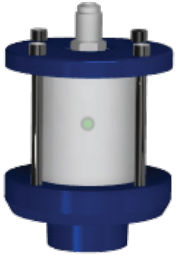

Grease Tanks

CFS AS1210 Pressure Rated	Part Number	Information
	CAN17	Capacity: 17 Litre Suits: 20kg leg (60lb) pumps Height: 530mm O/A Base Dia: 290mm
	CAN37	Capacity: 37 Litre Suits: 20kg leg (60lb) pumps Height: 530mm O/A Base Dia: 384mm
	CAN54	Capacity: 54 Litre Suits: 60kg leg (120lb) pumps Height: 740mm O/A Base Dia: 384mm
	CAN68	Capacity: 68 Litre Suits: 180kg leg (400lb) pumps Height: 925mm O/A Base Dia: 384mm
CFS NonRated	Part Number	Information
	CAN25	Capacity: 25 Litre Suits: 20kg leg (60lb) pumps Height: O/A Base Dia: 320mm
	CAN255	Capacity: 255 Litre Suits: 180kg leg (400lb) pumps Height: 925mm O/A Base Dia: 650mm



Grease Fill Shutoff Valves

V96 (External Mount)	Part Number	Information
	V96-KIT	Shut off valve (KIT) Hose Connection: 8 JICM Tank Connection: 2" BSP Male Kit includes: V96 shutoff valve, B9408 safety relief, R94 breather and instruction label.
	V96	Bare shut-off valve Hose Connection: -8 JIC Male Tank Connection: 2" BSP Male (Safety relief / breather sold separately).
	B94-08	Tank Breather Connection: 1/2" BSP Male
	R94	Safety Relief 25 psi Connection: 1/2" BSP Male
	V96L	Label Set (Operating Instructions)
	V96OR	Seal Kit (O-ring kit for V96)

SCAGFV (Internal Mount)	Part Number	Information
	SCA-GFV-3	Shut off valve (internal fitment) Hose Connection: 1-1/6" UNO Fem Tank Connection: 2" BSP Male (Safety relief / breather sold separately).
	BRV25-08	Breather / Safety Relief 25 psi Connection: 1/2" BSP Male

V96 – 20 (High Flow)	Part Number	Information
	V96-20	<p>Shut off valve: High Flow Rate</p> <p>Hose Connection: -20 JIC Male Tank</p> <p>Connection: 3" BSP Male</p> <p>(Safety relief / breather sold separately)</p>
	VR-32	<p>Breather / Safety Relief</p> <p>Connection: 2" BSP Male</p> <p>(use with V96-20)</p>

Grease FillPoint Manifolds

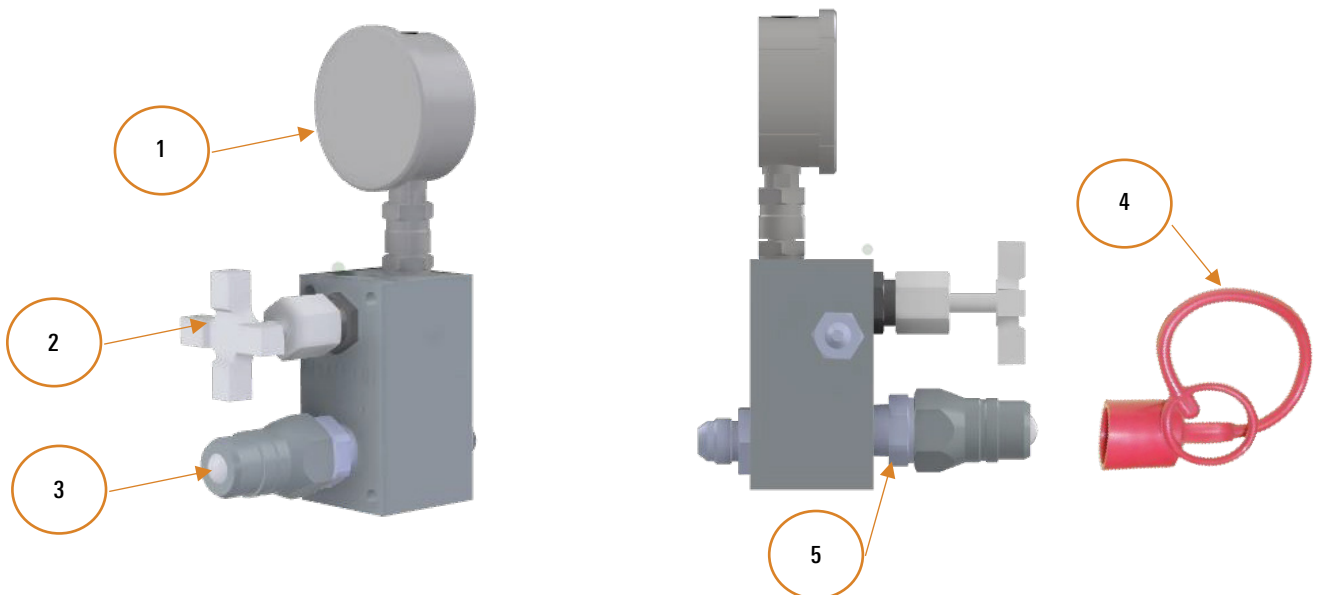

Images	Part Number	Information
	GFDK-01-001	Remote Fill-Point Manifold Hose Connection: -8 JIC Male Receiver: ISO-A 1/2" (use with V96 or SCA)
	V96-32FP	Fill Point Manifold (High Volume) Connection: 2" BSP Female (use with V96-20)

Repair Parts GFDK-01-001

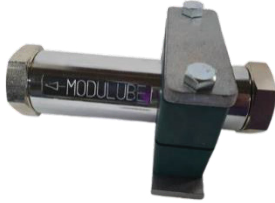

Item #	Description/Notes	Part Number
1	Grease Pressure Gauge 315bar	GPG63-315
2	Manual Release Valve	MVI400S
3	Receiver Nipple (may vary by customer site)	HA1503200
4	Dust Cap for Receiver	5657-10
5	Nipple 1/2" BSPP x 1/2" BSPT	BPM-BTM-0808

Grease Filters

Images	Part Number	Information
	MF2000-08 (use with V96 or SCA)	Brand: Modulube Filter Screen: 180 micron Hose Connection: 3/4" UNO Fem
	MF2000-12	As above: 1-1/16" UNO female
	01-267492	Brand: SKF Filter Screen: 250 micron Hose Connection: 3/4" NPT Fem

Grease Steel Tubing – Heavy Wall

Images	Part Number	Information
	6100053349	Heavy Wall Steel Tubing 10mm OD, 4mm ID (sold per metre)

Note: End user will need to cut 1/8" NPT threads onto the tube and bend to suit the application.