

HEAVY VEHICLE FIRE SUPPRESSION SYSTEM  
**FSI FOAM-GUARD SPARE PARTS  
MANUAL - V5.3**



Fire & Safety Industries Pty Ltd  
Global Fire Solutions  
[www.fireandsafety.com.au](http://www.fireandsafety.com.au)



THINK  
WORK  
HOME **SAFE**



## INTRODUCTION

This FSI Foam-Guard Spare Parts Manual – V5.3 (AS5062-2016) provides detailed information on authorised replacement components for FSI Foam-Guard Fire Suppression Systems, including Rise of Pressure (ROP), Loss of Pressure (LOP), and Electric Actuation configurations.

It is intended for use by personnel responsible for the ongoing maintenance of these systems. The technical data contained within this manual is to be used as a guide only.

FSI Foam-Guard Systems must be designed, installed, commissioned, and modified only by suitably trained and qualified FSI personnel or FSI-accredited distributors. Likewise, maintenance must only be carried out by appropriately trained FSI personnel, FSI-accredited distributors, or other formally qualified and competent individuals engaged in the full-time maintenance of vehicle fire suppression systems.

This manual also includes an approved list of spare parts, with visual references and verified part numbers, to ensure accurate identification, selection, and supply of components—supporting long-term reliability and compliance with AS5062-2016.

## DISCLAIMER

Fire & Safety Industries Pty Ltd disclaims any liability for use of data contained within this manual by any other party. This manual is an uncontrolled document when printed. FSI reserves the right to modify this manual at any time without prior notice.

All FSI personnel, FSI accredited distributors or other competent personnel shall ensure that always appropriate site safety procedures are adhered to when maintaining Foam-Guard systems.

Any modifications to the Pre-Engineered Foam-Guard System that occurs after commissioning shall first be approved by Fire & Safety Industries Pty Ltd.







In addition, it is important for owners, operators, hirers, and suppliers to provide details of all fire incidents to the vehicle manufacturer and the fire protection system manufacturer.





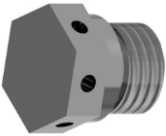

The technical data contained within this manual is to be used as a guide only. FSI Foam-Guard systems are to be designed, installed, commissioned, and modified by trained and competent FSI personnel or FSI accredited distributors only.

Foam-Guard systems are to be maintained by suitably trained and qualified FSI personnel, FSI accredited distributors or other formally qualified and competent personnel who are maintaining vehicle fire suppression systems on a full-time basis

SPARE PARTS LIST

CYLINDER DISCHARGE VALVE / COMPONENTS

FSI 90300EOL		F3 LOP DISCHARGE VALVE ASSY MK VI - EOL GREEN
FSI 90300I/L		F3 LOP DISCHARGE VALVE ASSY MK VI - I/L GREEN
FSI 90300-REV		F3 LOP DISCHARGE VALVE - REV THREADS, EOL TOP, 4 PIN SWITCH -
FSI 90300EOL-PRV		LOP DISCHARGE VALVE F3 - EOL C/W PRESSURE RELIEF VALVE
FSI 90300I/L-PRV		LOP DISCHARGE VALVE F3 - I/L C/W PRESSURE RELIEF VALVE
FSI 10300EOL		ROP DISCHARGE VALVE F3 - EOL GREEN
FSI 10300I/L		ROP DISCHARGE VALVE F3 - I/L GREEN
FSI 13002		F3 CYLINDER GAUGE 1400kPa
FSI 60000		BURST DISC ASSEMBLY
FSI 60000PRV		PRESSURE RELIEF VALVE ASSY
FSI 60012		VALVE OUTLET NIPPLE
FSI 60050		SHUTTLE ASSEMBLY MK VI
FSI 60009		SCHRADER VALVE WITH CAP 1/8" BSP

FSI 60010		SCHRADER VALVE WITH CAP 1/4" BSP
FSI 70036NP		NICKLE PLATED 1/4" BSP – 7/16" JIC NIPPLE
FSI 60051		ROP ACTUATOR PISTON (NEW STYLE - Post 2016)
FSI 10118		O RING KIT
FSI 60016		PORT PLUG
FSI 50002		SYPHON TUBE O RING

**SYPHON TUBES**

PART NO.	IMAGE	DESCRIPTION
FSI 60015		16L SYPHON TUBE
FSI 60018		23L SYPHON TUBE
FSI 60019		45L SYPHON TUBE
FSI 60020		65L SYPHON TUBE
FSI 60021		106L SYPHON TUBE
FSI 60022		23L SYPHON TUBE HORIZONTAL CYLINDER
FSI 60023		106L/65L SYPHON TUBE HORIZONTAL CYLINDER

**CYLINDERS**



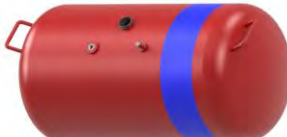

FSI 10000A		16L CYLINDER 527mm(H)x216mm(D)
FSI 10001A		23L CYLINDER 727mm(H)x216mm(D)



FSI 10002A		45L CYLINDER 577mm(H)x360mm(D)
FSI 10003A		65L CYLINDER 777mm(H)x360mm(D)
FSI 10004A		106L CYLINDER 1192mm(H)x360mm(D)

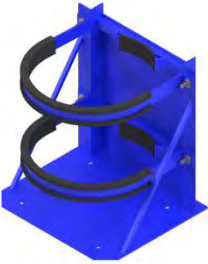

FSI 10001H	FSI 10003H	FSI 10004H
		
23 LITRE HORIZONTAL CYLINDER	65 LITRE HORIZONTAL CYLINDER	106 LITRE HORIZONTAL CYLINDER

**CYLINDER BRACKETS**

FSI 10019	BRACKET BAND FOR 45L, 65L & 106L
FSI 10102	BAND RUBBERS 2 OF (1 SHORT, 1 LONG) (1 SET PER BAND)

FSI 10021	FSI 10018	FSI 10020	FSI 10020HD	FSI 10020XHD
				
BRACKET CYL 16L/23L	BRACKET CYL 45L/65L	BRACKET CYL 106L	BRACKET CYL 106L 2 BAND H/DUTY	BRACKET CYL 106L 3 BAND EXT H/DUTY

FSI 10018SLB	FSI 10020SLB
	
BRACKET CYLINDER SLIMLINE 45L & 65L	BRACKET CYLINDER SLIMLINE 106L
FSI 10019SLB	BAND FOR SLIMLINE 45L, 65L & 106L

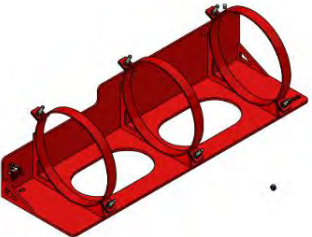
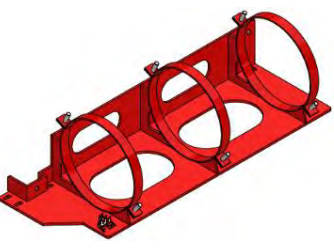
FSI 10021H	FSI 10018HB	FSI 10020HB-D65	FSI 10020HB-T45
			
BRACKET CYL HORIZONTAL 23L INC BAND	BRACKET CYL HORIZONTAL 65L INC BAND	BRACKET HORIZONTAL CYL 106L – EPIROC D65	BRACKET HORIZONTAL CYL 106L - EPIROC T45

**SYSTEM IDENTIFICATION LABELS**

PART NO. F3	DESCRIPTION
FSI 13001/12	16L CYLINDER LABEL
FSI 13001/17	23L CYLINDER LABEL
FSI 13001/17H	23L CYLINDER LABEL (HORIZONTAL CYLINDER)
FSI 13001/30	45L CYLINDER LABEL
FSI 13001/50	65L CYLINDER LABEL
FSI 13001/90	106L CYLINDER LABEL

				
16L Cylinder Label	23L Cylinder Label	45L Cylinder Label	65L Cylinder Label	106L Cylinder Label

**SIGNAGE AND LABELS**

<p><b>SMALL</b> FSI 10133</p> <p><b>LARGE</b> FSI 10134</p>		MANUAL ACTUATOR LOCATION SIGN SMALL / LARGE
FSI 10139		IN CASE OF FIRE LABEL
FSI 10140		YELLOW WARNING LABEL
FSI 10147		SHUTDOWN DELAY LABEL AS5062-2016
FSI 10143		AS5062 MAINTENANCE RECORD LABEL

FSI 40001		SERVICE & MAINTENANCE LABEL
FSI 10146		AS5062-2016 COMPLIANT LABEL (F3)
FSI 10146H		AS5062-2016 COMPLIANT LABEL 23LT HORIZONTAL CYLINDER
FSI 10120L		ROP DASH ACTUATOR LABEL
FSI 10007		ROP MANUAL ACTUATOR LABEL



### CYLINDER ULTRAMARINE BLUE BANDS

FSI 60038	SUIT 16L & 23LT CYLINDERS
FSI 60039	SUIT 45L & 65LT CYLINDERS
FSI 60040	SUIT 106L CYLINDER

### DISCHARGE HOSES

FSI 70005		19mm - (3/4") DISCHARGE HOSE
FSI 70014		12.5mm - (1/2") DISCHARGE HOSE

### ACTUATION HOSES

FSI 70029		6.3mm - (1/4") ACTUATION HOSE – ROP
FSI 90040		LOP ACTUATION HOSE

**HOSE PROTECTION**

FSI 10129		16mm - (1/4") SPIRAL GUARD to suit 6.3mm hose
FSI 10130		20mm - (1/2") SPIRAL GUARD to suit 12.5mm hose
FSI 10131		32mm - (3/4") SPIRAL GUARD to suit 19mm Hose
FSI 90045		12mm - SPIRAL GUARD to suit LOP Actuation Hose







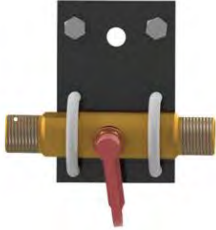

**FIRE SLEEVE**

FSI 10132B		1/4" FIRE SLEEVE to suit 6.3mm hose
FSI 10132		1/2" FIRE SLEEVE to suit 12.5mm hose
FSI 10132A		3/4" FIRE SLEEVE to suit 19mm hose







**P-CLAMPS**

FSI 70004		8mm P CLAMP suits Fire Harness
FSI 70033		12mm – (1/4") P CLAMP to suit 6.3mm hose
FSI 70017		20mm – (1/2") P CLAMP to suit 12.5mm Hose
FSI 70008		26mm – (3/4") P CLAMP to suit 19mm Hose.
FSI 90033		6mm SHEATHED P CLAMP

NOZZLES ASSEMBLIES / COMPONENTS





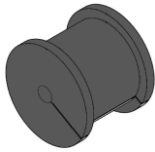
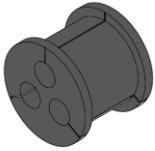
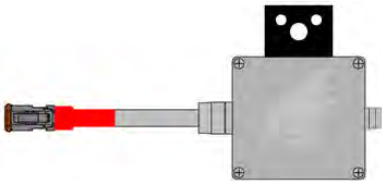
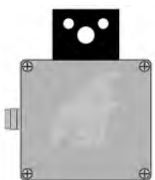



FSI 80001		SINGLE NOZZLE ASSEMBLY
FSI 80002		DOUBLE NOZZLE ASSEMBLY
FSI 80003		TRIPLE NOZZLE ASSEMBLY
FSI 60029		NOZZLE BARE
FSI 60029SP		NOZZLE BARE (PACK 10)
FSI 60033		SILICONE NOZZLE CAP
FSI 60033SP		SILICONE NOZZLE CAP (PACK 10)
FSI 30009		90 BENT NOZZLE PLATE







**DETECTION**

FSI 10009		1.0m MECHANICAL SENSOR MODULE
FSI 10010		1.5m MECHANICAL SENSOR MODULE
FSI 10024KIT		MSM SUPPORT PACK ASSY
FSI 91000		LOP DETECTION TUBE
FSI 91021		LOP TUBE INLINE CONNECTOR
FSI 91022		LOP TUBE END OF LINE CONNECTOR
FSI 91024		LOP CLEAR PASSAGE CONNECTOR
FSI 21000		LHD WIRE
FSI 21007		GROMMET SILICONE 1 HOLE C/W CLAMP
FSI 21013		GROMMET SILICONE 3 HOLE C/W CLAMP
FSI 21008		LHD INLINE ENCLOSURE
FSI 21009		LHD EOL ENCLOSURE





MANUAL ACTUATOR ASSEMBLIES / COMPONENTS

<p>FSI 93000</p>		<p>LOP REMOTE ACTUATOR ASSEMBLY (F3)</p>
<p>FSI 93002</p>		<p>LOP MANUAL ACTUATOR PRESSURE GAUGE (F3)</p>
<p>FSI 90112</p>		<p>SAFETY PIN ASSEMBLY LOP</p>
<p>FSI 91008</p>		<p>LOP ACTUATOR FASCIA</p>
<p>FSI 91007</p>		<p>LOP ACTUATOR LABEL (TRAFFOLYTE)</p>
<p>FSI 90009</p>		<p>LOP ACTUATOR MOUNTING ANGLE</p>
<p>FSI 90006</p>		<p>MODULE DISPLAY MODULE MOUNT LOP</p>

<p>FSI 100051</p>		<p>ROP MANUAL ACTUATOR ASSEMBLY (NO CARTRIDGE)</p>
<p>FSI 10006</p>		<p>CO2 CARTRIDGE</p>
<p>FSI 10101</p>		<p>ACTUATOR CARTRIDGE O RING</p>
<p>FSI 10120</p>		<p>ROP DASH ACTUATOR</p>
<p>FSI 10110</p>		<p>ACTUATOR STRIKE PIN ASSEMBLY</p>
<p>FSI 10112</p>		<p>SAFETY PIN ASSEMBLY</p>
<p>FSI 10107E</p>		<p>ACTUATOR KNOB</p>
<p>XSTIE</p>		<p>SECURITIE</p>
<p>FSI 10035</p>		<p>MODULE DISPLAY MODULE MOUNT ROP</p>

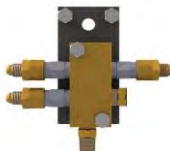
FSI 21312		0-2.5MPa 12V ROP Electric Solenoid
FSI 21412		0-2.5MPa 12V LOP Electric Solenoid
FSI 21106		V5 SOLENOID WIRING HARNESS
FSI 21100		ELECTRIC ACTUATOR EOL (Includes mounting plate)
FSI 21101		ELECTRIC ACTUATOR I/L (Includes mounting plate)
FSI 21102		ELECTRIC ACTUATOR I/L CAB (NO PLATE)
FSI 21103		ELECTRIC ACTUATOR & DISPLAY MOUNTING PLATE
FSI 21107		ELECTRIC I/L ACTUATOR CAB HARNESS
FSI 21108		ELECTRIC I/L ACTUATOR Y-HARNESS

ACTUATION MANIFOLD – ROP

FSI 10030A		ROP 4 WAY ACTUATION MANIFOLD C/W CHECK VALVES
FSI 10030B		ROP 3 WAY ACTUATION MANIFOLD C/W CHECK VALVES
FSI 10030D		ROP 2 WAY ACTUATION MANIFOLD C/W CHECK VALVES
FSI 10030C		ROP 2 WAY ACTUATION MANIFOLD - NO CHECK VALVES
FSI 10022		CHECK VALVE 1/4"



ACTUATION MANIFOLD – LOP

FSI 90032		LOP ACTUATION MANIFOLD – 5 WAY
FSI 90034		LOP ACTUATION MANIFOLD – 3 WAY
FSI 70061		7/16 JIC TEE F/M/M

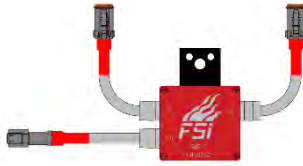
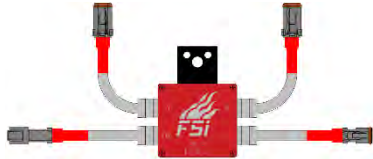

ENCLOSURES - PME

<p>FSI 20124</p>		<p>PRESSURE MONITORING ENCLOSURE (PME)</p>
------------------	---	--



ENCLOSURES - SME

<p>FSI 20122</p>		<p>SYSTEM MONITORING ENCLOSURE 2 CYL</p>
<p>FSI 20123</p>		<p>SYSTEM MONITORING ENCLOSURE 3 CYL</p>
<p>FSI 20125</p>		<p>CYLINDER PRESSURE &amp; SOLENOID ENCLOSURE (CPS)</p>
<p>FSI 20126</p>		<p>SME/CPS ENCLOSURE</p>







**THERMAL PROBES**

FSI 20120		INLINE PROBE
FSI 20121		END OF LINE PROBE









**PRESSURE SWITCHES**











FSI 23000		1400KPa 2 PIN LOW PRESSURE SWITCH F3
FSI 23001		1400KPa 4 PIN LOW PRESSURE SWITCH F3

**FIRE ALARM MODULES**

FSI 16017		<b>FSI V5 Shutdown Module Assembly</b> <ul style="list-style-type: none"> <li>• Display &amp; Control Module</li> <li>• 4m cable &amp; connectors</li> </ul>
FSI 16018		<b>FSI V5 Shutdown Module Assembly Battery Backup</b> <ul style="list-style-type: none"> <li>• Display &amp; Control Module</li> <li>• 4m cable &amp; connectors</li> <li>• Internal backup battery module</li> </ul>
FSI 16014		<b>FSI V5 Indicator Module Assembly</b> <ul style="list-style-type: none"> <li>• Display &amp; Control Module</li> <li>• 4m cable &amp; connectors</li> </ul>
FSI 16012		SHUTDOWN DISPLAY MODULE V5
FSI 16015		INDICATOR DISPLAY MODULE V5
FSI 16016		DISPLAY CABLE V4 / V5
FSI 16003		BATTERY PACK V4/V5
FSI 16032		RTC BATTERY
FSI 16033		SD CARD
FSI 59005		AssetCONNECT App ACCESS

FITTINGS







FSI 70007		3/4" BSP BULKHEAD FITTING
FSI 70009		3/4" TEE
FSI 70010		3/4" M&F ELBOW
FSI 70011		3/4" x 1/2" NIPPLE
FSI 70012		3/4" NIPPLE
FSI 70013		3/4" x 1/2" BUSH
FSI 70013A		3/4" (F) x 1/2" (M) ADAPTOR
FSI 70016		1/2" BSP BULKHEAD FITTING

FSI 70018		1/2" x 1/4" BUSH
FSI 70019		1/2" NIPPLE
FSI 70020		1/2" TEE
FSI 70021		1/2" M&F ELBOW
FSI 70026C		1/2" BSP BLANKING CAP
FSI 70032		7/16" JIC BULKHEAD FITTING
FSI 70034		1/4" NPT (F) - 7/16" JIC (M) SOCKET
FSI 70036		1/4" BSP (M) - 7/16" JIC (M) NIPPLE
FSI 70037L		1/4" M&F ELBOW LONG
FSI 70039		1/4" BSP TEE

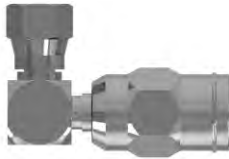

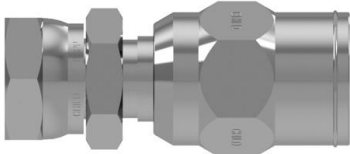
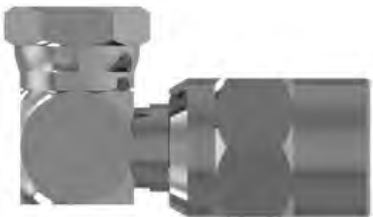







FSI 70040		1/4" BSP PLUG
FSI 70041		1/4" BSP BULKHEAD FITTING
FSI 70042		1/4" BSP NIPPLE
FSI 70044		1/4" BSP (M) – 1/8" BSP (M) NIPPLE
FSI 70045		1/4" BSP (M) – 1/8" NPT (F) BUSH
FSI 70054		1/8" BSP (M) – 7/16" JIC (M) NIPPLE
FSI 70055		1/8" NPT (F) – 7/16" JIC (M) SOCKET
FSI 70057MRT		1/8" x 1/8" MALE RUN TEE
FSI 70060		7/16" JIC CAP

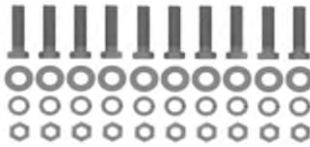

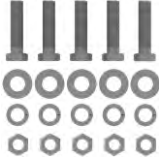
FSI 70028PPSINLET		MODULE PRESSURE SWITCH INLET
FSI 70028STDINLET		3/4" INLET ASSEMBLY
FSI 86000		3/4" TWIN CYLINDER MANIFOLD
FSI 70070		3/4" MODULE PRESSURE SWITCH INLET
FSI 70048		PTFE TAPE

HOSE FITTINGS





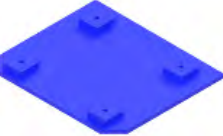



FSI 70030-90		7/16" JIC 90 DEG HOSE END to suit 6.3mm hose
FSI 70031		7/16" JIC HOSE END to suit 6.3mm hose
FSI 10121		1/4" BSP HOSE END to suit 6.3mm hose
FSI 70015		1/2" BSP HOSE END to suit 12.5mm Hose
FSI 70006		3/4" BSP HOSE END to suit 19mm Hose
FSI 10122-90		1/4" BSP 90 DEG HOSE END to suit 6.3mm hose
FSI 70015-90		1/2" BSP 90 DEG HOSE END to suit 12.5mm Hose
FSI 70006-90		3/4" BSP 90 DEG HOSE END to suit 19mm Hose
FSI 90052		LOP ACTUATION HOSE FITTING 316SS 90 DEG
FSI90051		LOP ACTUATION HOSE FITTING 316SS ST
FSI 90044		LOP ACTUATION HOSE METAL CLIP PK 10

**FASTENERS**

FSI 01258M		BOLT KIT M10 (PACK 4)
FSI 01259M		BOLT KIT M12 (PACK 4)
FSI 01260M		BOLT KIT M6 (PACK 10)
FSI 01260MFSP		M6 FLAT WASHER PACK (20)
FSI 01259MSLB		BOLT KIT M12 (5)
FSI 01259MCAP		M12x25 SOCKET CAP SCREW KIT
FSI 01259MHDCAP		M12x35 SOCKET CAP SCREW KIT
FSI 01259MCAPSLB		M12 x 25 SOCKET CAP SCREW BOLT KIT (5)
FSI 70090		MAGNETIC MOUNT
FSI 01258MRPK		M10 ROD – STEP OUT ADAPTOR (PACK OF 10)

FSI BKTBLOCK		CYLINDER MOUNTING BLOCKS
FSI INT-DECK		CYLINDER DECK PLATE
FSI INT-DECKSLB		SLIMLINE BRACKET MOUNTING PLATE





## ELECTRICAL







FSI 20016		DT CONNECTOR KIT – 2 PIN
FSI 20017		DT CONNECTOR KIT – 4 PIN
FSI 20140		FLY LEAD ADAPTOR 2 PIN F/F
FSI 20141		FLY LEAD ADAPTOR 2 PIN M/M
FSI 01282		2 CORE FIRE HARNESS
FSI 01284		4 CORE FIRE HARNESS
FSI 20020		PLASTIC GLAND 16mm
FSI 70049		CABLE TIE LARGE NYLON
FSI 70049S		CABLE TIE SMALL NYLON
FSI 10049		SWIVEL CABLE TIE MOUNT

FOAM

FSI 13000		20 LITRE DRUM F3
-----------	---	------------------

TOOLING AND CONSUMABLES

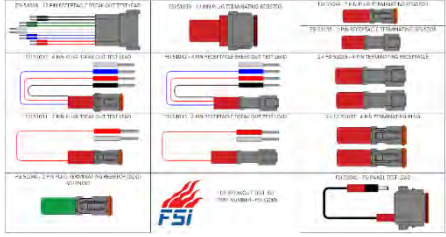
FSI 50000		NITROGEN REGULATOR
FSI 50001		CHARGING KIT 2 x 1.0m 1 x 8.0m
FSI 50001/A		LOP MULTI CYLINDER CHARGE RIG 2 x 1.5m 2 x 2.0m 2 x 2.5m
FSI 50001/B		MULTI-CYLINDER CHARGING ADAPTOR KIT (8 CYL'S) 2 x 1.5m 2 x 2.0m 2 x 2.5m 2 x 3.0m

FSI 51010		LINE FLUSHING ADAPTOR
FSI 51005		ACTUATION LINE TEST RIG
FSI 51008		1/2" ISOLATION CAP VALVE
FSI 51004		3/4" ISOLATION CAP VALVE
FSI 51007		SCHRADER VALVE RELIEF TOOL
FSI 51030		DEUTSCH PLUG BREAKOUT TEST KIT
FSI 90046		NYLOG BLUE – Thread Sealant
FSI 90047		Crimping Tool (Actuation hose Clips)

FSI 50022		LIQUID LEAK DETECTOR
FSI 50023		LOCTITE 577 HIGH PRESSURE SEALANT
FSI 50020		MOLYKOTE 111
FSI 50021		DOW CORNING No.4
FSI 20038		BIZ'GEL EXPRESS SEALING GEL 280ml CARTRIDGE
FSI 50018		LOCTITE 263 THREAD LOCKER
FSI 50019		LOCTITE 569 THREAD SEALANT

### CYLINDER FILL TUBES

FSI 50155 (15.5) & FSI 50170 (17)	23L CYLINDER FILL TUBES
FSI 50280 (28) & FSI 50300 (30)	45L CYLINDER FILL TUBES
FSI 50460 (46) & FSI 50500 (50)	65L CYLINDER FILL TUBES
FSI 50840 (84) & FSI 50900 (90)	106L CYLINDER FILL TUBES
FSI 50900SET	CYLINDER FILL TUBE SET

FSI 50155H	CYLINDER FILL TUBE - 15.5L HORIZONTAL CYLINDER
FSI 50170H	CYLINDER FILL TUBE - 17L HORIZONTAL CYLINDER
FSI 50460H	CYLINDER FILL TUBE - 46L HORIZONTAL CYLINDER
FSI 50500H	CYLINDER FILL TUBE - 50L HORIZONTAL CYLINDER
FSI 50840H	CYLINDER FILL TUBE - 84L HORIZONTAL CYLINDER
FSI 50900H	CYLINDER FILL TUBE - 90L HORIZONTAL CYLINDER
FSI 50900SETH	CYLINDER FILL TUBE SET (HORIZONTAL)



NOTES