



MILLENNIUM COUPLING COMPANY



INDUSTRIAL COUPLINGS AND COMPONENTS

MILLENNIUM COUPLING COMPANY

MILLENNIUM COUPLING COMPANY

ASIA PACIFIC  
5 Myer Court  
Beverley  
South Australia  
5009  
Australia

T 1300 853 250 +61 8 8429 2010

F 08 8429 2019 +61 8 8429 2019

E [sales@mcc-ltd.com.au](mailto:sales@mcc-ltd.com.au)

[www.mcc-ltd.com.au](http://www.mcc-ltd.com.au)

"WE WORK UNDER PRESSURE!"



INDUSTRIAL COUPLINGS AND COMPONENTS



# CONTENTS

COMPANY INFORMATION 02

	CAM & GROOVE COUPLINGS	03-16
	EXTERNAL CRIMP COUPLINGS	17-30
	QUICK COUPLINGS	31-50
	SUCTION & DELIVERY	51-58
	CLAMPING SYSTEMS	59-64
	DIN COUPLINGS	65-76
	VALVES	77-84
	FIRE PRODUCTS	85-92
	PNEUMATICS	93-102
	150lb THREADED PARTS	103-112





# WELCOME TO MILLENNIUM COUPLING COMPANY

The **Millennium Coupling Company (MCC)** was founded more than 15 years ago in the United Kingdom and has grown to become one of the leading suppliers of hose fittings and related accessories in Europe.

The expansion of MCC into the Asia-Pacific region in 2015 marked an exciting time in the Company's history. With European heritage and a global manufacturing network, **MCC-Australia** is your hose coupling supply and design solution specialist.

**MCC-Australia** offers a comprehensive range of quality, value for money industrial grade products tailored to meet the needs of the Australian market.

With extensive and consolidated stock holdings in a modern distribution centre, **MCC-Australia** ensures customers receive delivery in full and on time. Customers also enjoy free fast shipping Australia wide\*.

**MCC-Australia** utilises the latest technology to offer unparalleled ease of doing business. Customers benefit from fast and simple ordering, live price and availability enquiry, order tracking and technical support. All available 24 /7 via web or mobile at [www.mcc-ltd.com.au](http://www.mcc-ltd.com.au).

\*Conditions Apply

## MCC - AUSTRALIA

5 Myer Court  
Beverley  
South Australia  
5009

T 1300 853 250 | +61 8 8429 2010  
F 08 8429 2019 | +61 8 8429 2019  
E [sales@mcc-ltd.com.au](mailto:sales@mcc-ltd.com.au)

[www.mcc-ltd.com.au](http://www.mcc-ltd.com.au)















MILLENNIUM COUPLING COMPANY

“WE WORK UNDER PRESSURE!”

# 01

## CAM & GROOVE COUPLINGS

	Aluminium Cam & Groove Couplings	4
	Brass Cam & Groove Couplings	5
	Stainless Steel 316 Cam & Groove Couplings	6
	Polypropylene Cam & Groove Couplings	7-8
	IBC Fittings	8
	Nyglass Cam & Groove Couplings	9
	Reducing Camlocks and Spool Couplings	10
	Spiral Tail Composite Hose Couplings	11
	Stainless Steel 'Pull Lock' Couplings	12
	DIN EN 14420-7 (DIN2828) Smoothtail Couplings	12
	Flanged, 68° Bends & Dry Disconnect Couplings	13
	Camlock Gaskets & Spares	14
	Mortar Couplings	15-16



## ALUMINIUM CAMLOCKS

## Features:

- fitted with stainless handles and pins
- collar provision for crimping
- supplied with safety pins
- NPT threads also available (add NPT to end of part#)
- NBR seals supplied, EPDM & FKM seals page 14

## TECHNICAL DATA

MAXIMUM PRESSURE RATINGS\* - Aluminium

\*based upon liquid media at a temperature of 21°C with a standard NBR seal

Size	15mm	20-50mm	65mm	80mm	100mm	125-150mm	200mm
Pressure kPa	1035	1725	1035	1035	1035	520	345
Pressure psi	150	250	150	150	150	75	50



Type A (BSPP)

SIZE	PART#
1/2" (15mm)	A050AL
3/4" (20mm)	A075AL
1" (25mm)	A100AL
1-1/4" (32mm)	A125AL
1-1/2" (40mm)	A150AL
2" (50mm)	A200AL
2-1/2" (65mm)	A250AL
3" (80mm)	A300AL
4" (100mm)	A400AL
5" (125mm)	A500AL
6" (150mm)	A600AL
8" (200mm)	A800AL



Type B (BSPT)

SIZE	PART#
1/2" (15mm)	B050AL
3/4" (20mm)	B075AL
1" (25mm)	B100AL
1-1/4" (32mm)	B125AL
1-1/2" (40mm)	B150AL
2" (50mm)	B200AL
2-1/2" (65mm)	B250AL
3" (80mm)	B300AL
4" (100mm)	B400AL
5" (125mm)	B500AL
6" (150mm)	B600AL
8" (200mm)	B800AL



Type C

SIZE	PART#
1/2" (15mm)	C050AL
3/4" (20mm)	C075AL
1" (25mm)	C100AL
1-1/4" (32mm)	C125AL
1-1/2" (40mm)	C150AL
2" (50mm)	C200AL
2-1/2" (65mm)	C250AL
3" (80mm)	C300AL
4" (100mm)	C400AL
5" (125mm)	C500AL
6" (150mm)	C600AL
8" (200mm)	C800AL



Type D (BSPP)

SIZE	PART#
1/2" (15mm)	D050AL
3/4" (20mm)	D075AL
1" (25mm)	D100AL
1-1/4" (32mm)	D125AL
1-1/2" (40mm)	D150AL
2" (50mm)	D200AL
2-1/2" (65mm)	D250AL
3" (80mm)	D300AL
4" (100mm)	D400AL
5" (125mm)	D500AL
6" (150mm)	D600AL
8" (200mm)	D800AL



Type E

SIZE	PART#
1/2" (15mm)	E050AL
3/4" (20mm)	E075AL
1" (25mm)	E100AL
1-1/4" (32mm)	E125AL
1-1/2" (40mm)	E150AL
2" (50mm)	E200AL
2-1/2" (65mm)	E250AL
3" (80mm)	E300AL
4" (100mm)	E400AL
5" (125mm)	E500AL
6" (150mm)	E600AL
8" (200mm)	E800AL



Type F (BSPT)

SIZE	PART#
1/2" (15mm)	F050AL
3/4" (20mm)	F075AL
1" (25mm)	F100AL
1-1/4" (32mm)	F125AL
1-1/2" (40mm)	F150AL
2" (50mm)	F200AL
2-1/2" (65mm)	F250AL
3" (80mm)	F300AL
4" (100mm)	F400AL
5" (125mm)	F500AL
6" (150mm)	F600AL
8" (200mm)	F800AL



Type DC

SIZE	PART#
1/2" (15mm)	DC050AL
3/4" (20mm)	DC075AL
1" (25mm)	DC100AL
1-1/4" (32mm)	DC125AL
1-1/2" (40mm)	DC150AL
2" (50mm)	DC200AL
2-1/2" (65mm)	DC250AL
3" (80mm)	DC300AL
4" (100mm)	DC400AL
5" (125mm)	DC500AL
6" (150mm)	DC600AL
8" (200mm)	DC800AL



Type DP

SIZE	PART#
1/2" (15mm)	DP050AL
3/4" (20mm)	DP075AL
1" (25mm)	DP100AL
1-1/4" (32mm)	DP125AL
1-1/2" (40mm)	DP150AL
2" (50mm)	DP200AL
2-1/2" (65mm)	DP250AL
3" (80mm)	DP300AL
4" (100mm)	DP400AL
5" (125mm)	DP500AL
6" (150mm)	DP600AL
8" (200mm)	DP800AL

# BRASS CAM & GROOVE COUPLINGS

## BRASS CAMLOCKS

### Features:

- fitted with stainless handles and pins
- collar provision for crimping
- supplied with safety pins
- NPT threads also available (add NPT to end of part#)
- NBR seals supplied, EPDM & FKM seals page 14

### TECHNICAL DATA

MAXIMUM PRESSURE RATINGS\* - Brass

\*based upon liquid media at a temperature of 21°C with a standard NBR seal

Size	15mm	20-50mm	65mm	80mm	100mm	125-150mm
Pressure kPa	1035	1725	1035	1035	1035	520
Pressure psi	150	250	150	150	150	75



**Type A (BSPP)**

SIZE	PART#
1/2" (15mm)	A050BR
3/4" (20mm)	A075BR
1" (25mm)	A100BR
1-1/4" (32mm)	A125BR
1-1/2" (40mm)	A150BR
2" (50mm)	A200BR
2-1/2" (65mm)	A250BR
3" (80mm)	A300BR
4" (100mm)	A400BR
5" (125mm)	A500BR
6" (150mm)	A600BR



**Type B (BSPT)**

SIZE	PART#
1/2" (15mm)	B050BR
3/4" (20mm)	B075BR
1" (25mm)	B100BR
1-1/4" (32mm)	B125BR
1-1/2" (40mm)	B150BR
2" (50mm)	B200BR
2-1/2" (65mm)	B250BR
3" (80mm)	B300BR
4" (100mm)	B400BR
5" (125mm)	B500BR
6" (150mm)	B600BR



**Type C**

SIZE	PART#
1/2" (15mm)	C050BR
3/4" (20mm)	C075BR
1" (25mm)	C100BR
1-1/4" (32mm)	C125BR
1-1/2" (40mm)	C150BR
2" (50mm)	C200BR
2-1/2" (65mm)	C250BR
3" (80mm)	C300BR
4" (100mm)	C400BR
5" (125mm)	C500BR
6" (150mm)	C600BR



**Type D (BSPP)**

SIZE	PART#
1/2" (15mm)	D050BR
3/4" (20mm)	D075BR
1" (25mm)	D100BR
1-1/4" (32mm)	D125BR
1-1/2" (40mm)	D150BR
2" (50mm)	D200BR
2-1/2" (65mm)	D250BR
3" (80mm)	D300BR
4" (100mm)	D400BR
5" (125mm)	D500BR
6" (150mm)	D600BR



**Type E**

SIZE	PART#
1/2" (15mm)	E050BR
3/4" (20mm)	E075BR
1" (25mm)	E100BR
1-1/4" (32mm)	E125BR
1-1/2" (40mm)	E150BR
2" (50mm)	E200BR
2-1/2" (65mm)	E250BR
3" (80mm)	E300BR
4" (100mm)	E400BR
5" (125mm)	E500BR
6" (150mm)	E600BR



**Type F (BSPT)\***

SIZE	PART#
1/2" (15mm)	F050BR
3/4" (20mm)	F075BR
1" (25mm)	F100BR
1-1/4" (32mm)	F125BR
1-1/2" (40mm)	F150BR
2" (50mm)	F200BR
2-1/2" (65mm)	F250BR
3" (80mm)	F300BR
4" (100mm)	F400BR
5" (125mm)	F500BR
6" (150mm)	F600BR



**Type DC**

SIZE	PART#
1/2" (15mm)	DC050BR
3/4" (20mm)	DC075BR
1" (25mm)	DC100BR
1-1/4" (32mm)	DC125BR
1-1/2" (40mm)	DC150BR
2" (50mm)	DC200BR
2-1/2" (65mm)	DC250BR
3" (80mm)	DC300BR
4" (100mm)	DC400BR
5" (125mm)	DC500BR
6" (150mm)	DC600BR



**Type DP**

SIZE	PART#
1/2" (15mm)	DP050BR
3/4" (20mm)	DP075BR
1" (25mm)	DP100BR
1-1/4" (32mm)	DP125BR
1-1/2" (40mm)	DP150BR
2" (50mm)	DP200BR
2-1/2" (65mm)	DP250BR
3" (80mm)	DP300BR
4" (100mm)	DP400BR
5" (125mm)	DP500BR
6" (150mm)	DP600BR

## GRADE 316 STAINLESS STEEL CAMLOCKS

## Features:

- fitted with stainless handles and pins
- collar provision for crimping
- supplied with safety pins
- NPT threads also available (add NPT to end of part#)
- NBR seals supplied, EPDM & FKM seals page 14

## TECHNICAL DATA

## MAXIMUM PRESSURE RATINGS\* - Stainless Steel

\*based upon liquid media at a temperature of 21°C with a standard NBR seal

Size	15mm	20-50mm	65mm	80mm	100mm	125-150mm
Pressure kPa	1035	1725	1035	1035	1035	520
Pressure psi	150	250	150	150	150	75



Type A (BSPP)

SIZE	PART#
1/2" (15mm)	A050SS
3/4" (20mm)	A075SS
1" (25mm)	A100SS
1-1/4" (32mm)	A125SS
1-1/2" (40mm)	A150SS
2" (50mm)	A200SS
2-1/2" (65mm)	A250SS
3" (80mm)	A300SS
4" (100mm)	A400SS
5" (125mm)	A500SS
6" (150mm)	A600SS



Type B (BSPT)

SIZE	PART#
1/2" (15mm)	B050SS
3/4" (20mm)	B075SS
1" (25mm)	B100SS
1-1/4" (32mm)	B125SS
1-1/2" (40mm)	B150SS
2" (50mm)	B200SS
2-1/2" (65mm)	B250SS
3" (80mm)	B300SS
4" (100mm)	B400SS
5" (125mm)	B500SS
6" (150mm)	B600SS



Type C

SIZE	PART#
1/2" (15mm)	C050SS
3/4" (20mm)	C075SS
1" (25mm)	C100SS
1-1/4" (32mm)	C125SS
1-1/2" (40mm)	C150SS
2" (50mm)	C200SS
2-1/2" (65mm)	C250SS
3" (80mm)	C300SS
4" (100mm)	C400SS
5" (125mm)	C500SS
6" (150mm)	C600SS



Type D (BSPP)

SIZE	PART#
1/2" (15mm)	D050SS
3/4" (20mm)	D075SS
1" (25mm)	D100SS
1-1/4" (32mm)	D125SS
1-1/2" (40mm)	D150SS
2" (50mm)	D200SS
2-1/2" (65mm)	D250SS
3" (80mm)	D300SS
4" (100mm)	D400SS
5" (125mm)	D500SS
6" (150mm)	D600SS



Type E

SIZE	PART#
1/2" (15mm)	E050SS
3/4" (20mm)	E075SS
1" (25mm)	E100SS
1-1/4" (32mm)	E125SS
1-1/2" (40mm)	E150SS
2" (50mm)	E200SS
2-1/2" (65mm)	E250SS
3" (80mm)	E300SS
4" (100mm)	E400SS
5" (125mm)	E500SS
6" (150mm)	E600SS



Type F (BSPT)

SIZE	PART#
1/2" (15mm)	F050SS
3/4" (20mm)	F075SS
1" (25mm)	F100SS
1-1/4" (32mm)	F125SS
1-1/2" (40mm)	F150SS
2" (50mm)	F200SS
2-1/2" (65mm)	F250SS
3" (80mm)	F300SS
4" (100mm)	F400SS
5" (125mm)	F500SS
6" (150mm)	F600SS



Type DC

SIZE	PART#
1/2" (15mm)	DC050SS
3/4" (20mm)	DC075SS
1" (25mm)	DC100SS
1-1/4" (32mm)	DC125SS
1-1/2" (40mm)	DC150SS
2" (50mm)	DC200SS
2-1/2" (65mm)	DC250SS
3" (80mm)	DC300SS
4" (100mm)	DC400SS
5" (125mm)	DC500SS
6" (150mm)	DC600SS



Type DP

SIZE	PART#
1/2" (15mm)	DP050SS
3/4" (20mm)	DP075SS
1" (25mm)	DP100SS
1-1/4" (32mm)	DP125SS
1-1/2" (40mm)	DP150SS
2" (50mm)	DP200SS
2-1/2" (65mm)	DP250SS
3" (80mm)	DP300SS
4" (100mm)	DP400SS
5" (125mm)	DP500SS
6" (150mm)	DP600SS

# POLYPROPYLENE CAM & GROOVE COUPLINGS

## POLYPROPYLENE CAMLOCKS

### Features:

- fitted with stainless handles and pins
- supplied with safety pins
- NPT threads also available (add NPT to end of part#)
- EPDM seals supplied, NBR & FKM seals page 14
- C050PP: 20mm coupler x 15mm tail
- DC075PP and DP075PP: fit 15mm fittings

### TECHNICAL DATA

MAXIMUM PRESSURE RATINGS\* - Polypropylene  
 \*based upon liquid media at a temperature of 21°C with a standard EPDM seal

Size	15mm	20 - 25mm	32-65mm	80mm	100mm
Pressure kPa	865	865	690	520	520
Pressure psi	125	125	100	75	75



**Type A (BSPP)**

SIZE	PART#
1/2" (15mm)	A050PP
3/4" (20mm)	A075PP
1" (25mm)	A100PP
1-1/4" (32mm)	AT125PP
1-1/2" (40mm)	A150PP
2" (50mm)	A200PP
3" (80mm)	A300PP
4" (100mm)	A400PP



**Type B (BSPT)**

SIZE	PART#
1/2" (15mm)	B050PP
3/4" (20mm)	B075PP
1" (25mm)	B100PP
1-1/4" (32mm)	BT125PP
1-1/2" (40mm)	B150PP
2" (50mm)	B200PP
3" (80mm)	B300PP
4" (100mm)	B400PP



**Type C**

SIZE	PART#
1/2" (15mm)	C050PP
3/4" (20mm)	C075PP
1" (25mm)	C100PP
1-1/4" (32mm)	CT125PP
1-1/2" (40mm)	C150PP
2" (50mm)	C200PP
3" (80mm)	C300PP
4" (100mm)	C400PP



**Type D (BSPP)**

SIZE	PART#
1/2" (15mm)	D050PP
3/4" (20mm)	D075PP
1" (25mm)	D100PP
1-1/4" (32mm)	DT125PP
1-1/2" (40mm)	D150PP
2" (50mm)	D200PP
3" (80mm)	D300PP
4" (100mm)	D400PP



**Type E**

SIZE	PART#
1/2" (15mm)	E050PP
3/4" (20mm)	E075PP
1" (25mm)	E100PP
1-1/4" (32mm)	ET125PP
1-1/2" (40mm)	E150PP
2" (50mm)	E200PP
3" (80mm)	E300PP
4" (100mm)	E400PP



**Type F (BSPT)**

SIZE	PART#
1/2" (15mm)	F050PP
3/4" (20mm)	F075PP
1" (25mm)	F100PP
1-1/4" (32mm)	FT125PP
1-1/2" (40mm)	F150PP
2" (50mm)	F200PP
3" (80mm)	F300PP
4" (100mm)	F400PP



**Type DC**

SIZE	PART#
1/2" (15mm)	DC075PP
3/4" (20mm)	DC075PP
1" (25mm)	DC100PP
1-1/4" (32mm)	DCT125PP
1-1/2" (40mm)	DC150PP
2" (50mm)	DC200PP
3" (80mm)	DC300PP
4" (100mm)	DC400PP



**Type DP**

SIZE	PART#
1/2" (15mm)	DP075PP
3/4" (20mm)	DP075PP
1" (25mm)	DP100PP
1-1/4" (32mm)	DPT125PP
1-1/2" (40mm)	DP150PP
2" (50mm)	DP200PP
3" (80mm)	DP300PP
4" (100mm)	DP400PP



**A**  
**90° Elbows 1 1/2" (150mm)**



**C**



**D**



**F**

**90° Elbows 2" (200mm)**

ITEM	PART#	DESCRIPTION
A	150A90	90° Male Adaptor 1.1/2" Female Thread
C	150C90	90° Female Coupler 1.1/2" Hose Shank
D	150D90	90° Female Coupler 1.1/2" Female Thread
F	150F90	90° Male Adaptor 1.1/2" Male Thread

ITEM	PART#	DESCRIPTION
A	200A90	90° Male Adaptor 2" Female Thread
C	200C90	90° Female Coupler 2" Hose Shank
D	200D90	90° Female Coupler 2" Female thread
F	200F90	90° Male Adaptor 2" Male thread

## "Stubby Valve"™ PATENTED

### TECHNICAL INFORMATION

- All Teflon seals
- Unique patented compact design
- Stainless steel bolts
- Lightweight
- Glass filled polypropylene
- Maximum operating pressure 100PSI @ 70°F, 75 PSI @ 150°F.



**2" Standard Port Cam & Groove Ball Valves  
Reduced Port**

PART#	DESCRIPTION
VSF200B	2" Male Adaptor x 2" Female BSP Thread
VSFM200B	2" Male Adaptor x 2" Male BSP Thread

## IBC COUPLINGS



**IBC 60mm  
Female x Male  
Camlock**

SIZE	PART#
1"	A100PPBU
1-1/2"	A150PPBU
2"	A200PPBU



**IBC 60mm  
Female x Female  
BSP Thread**

SIZE	PART#
1-1/2"	IBC150PP
2"	IBC200PP



**IBC 60mm  
Tank Valve**

SIZE	PART#
2"	IBCTV2PP

### Features:

- EPDM gasket
- polypropylene body, aluminium ring

# NYGLASS CAM & GROOVE COUPLINGS

## NYGLASS CAMLOCKS

### Features:

- fitted with stainless handles and pins
- supplied with safety pins
- NPT threads also available
- NBR seals supplied, EPDM & FKM seals page 14
- C050NG: 20mm coupler x 15mm tail
- DC075NG and DP075NG: fit 15mm fittings

### TECHNICAL DATA

MAXIMUM PRESSURE RATINGS\* - Nyglass

\*based upon liquid media at a temperature of 21°C with a standard NBR seal

Size	15mm	20 - 25mm	32-65mm	80mm	100mm
Pressure kPa	865	865	690	520	520
Pressure psi	125	125	100	75	75



**Type A (BSPP)**

SIZE	PART#
1/2" (15mm)	A050NG
3/4" (20mm)	A075NG
1" (25mm)	A100NG
1-1/4" (32mm)	A125NG
1-1/4" x 1-1/2" (32mm x 40mm)	A1513NG
1-1/2" (40mm)	A150NG
2" (50mm)	A200NG
3" (80mm)	A300NG
4" (100mm)	A400NG



**Type B (BSPT)**

SIZE	PART#
1/2" (15mm)	B050NG
3/4" (20mm)	B075NG
1" (25mm)	B100NG
1-1/4" (32mm)	B125NG
1-1/4" x 1-1/2" (32mm x 40mm)	B1513NG
1-1/2" (40mm)	B150NG
2" (50mm)	B200NG
3" (80mm)	B300NG
4" (100mm)	B400NG



**Type C**

SIZE	PART#
1/2" (15mm)	C050NG
3/4" (20mm)	C075NG
1" (25mm)	C100NG
1-1/4" (32mm)	C125NG
1-1/4" x 1-1/2" (32mm x 40mm)	C1513NG
1-1/2" (40mm)	C150NG
2" (50mm)	C200NG
3" (80mm)	C300NG
4" (100mm)	C400NG



**Type D (BSPP)**

SIZE	PART#
1/2" (15mm)	D050NG
3/4" (20mm)	D075NG
1" (25mm)	D100NG
1-1/4" (32mm)	D125NG
1-1/4" x 1-1/2" (32mm x 40mm)	D1513NG
1-1/2" (40mm)	D150NG
2" (50mm)	D200NG
3" (80mm)	D300NG
4" (100mm)	D400NG



**Type E**

SIZE	PART#
1/2" (15mm)	E050NG
3/4" (20mm)	E075NG
1" (25mm)	E100NG
1-1/4" (32mm)	E125NG
1-1/4" x 1-1/2" (32mm x 40mm)	E1513NG
1-1/2" (40mm)	E150NG
2" (50mm)	E200NG
3" (80mm)	E300NG
4" (100mm)	E400NG



**Type F (BSPT)**

SIZE	PART#
1/2" (15mm)	F050NG
3/4" (20mm)	F075NG
1" (25mm)	F100NG
1-1/4" (32mm)	F125NG
1-1/4" x 1-1/2" (32mm x 40mm)	F1513NG
1-1/2" (40mm)	F150NG
2" (50mm)	F200NG
3" (80mm)	F300NG
4" (100mm)	F400NG



**Type DC**

SIZE	PART#
1/2" (15mm)	DC075NG
3/4" (20mm)	DC075NG
1" (25mm)	DC100NG
1-1/4" (32mm)	DC125NG
1-1/2" (40mm)	DC150NG
2" (50mm)	DC200NG
3" (80mm)	DC300NG
4" (100mm)	DC400NG



**Type DP**

SIZE	PART#
1/2" (15mm)	DP075NG
3/4" (20mm)	DP075NG
1" (25mm)	DP100NG
1-1/4" (32mm)	DP125NG
1-1/2" (40mm)	DP150NG
2" (50mm)	DP200NG
3" (80mm)	DP300NG
4" (100mm)	DP400NG

## REDUCING CAMLOCKS



## Aluminium Reducing Camlocks

TYPE	SIZE	PART#
A	50mm (2") ADAPTOR x 80mm (3") F BSP	A2030AL
A	80mm (3") ADAPTOR X 50mm (2") F BSP	A3020AL
A	80mm (3") ADAPTOR X 100mm (4") F BSP	A3040AL
A	100mm (4") ADAPTOR X 80mm (3") F BSP	A4030AL
B	50mm (2") COUPLER X 40mm (1-1/2") M BSP	B2015AL
B	80mm (3") COUPLER X 100mm (4") M BSP	B3040AL
B	100mm (4") COUPLER X 80mm (3") M BSP	B4030AL
C	80mm (3") COUPLER X 50mm (2") H/T	C3020AL
C	80mm (3") COUPLER X 100mm (4") H/T	C3040AL
C	100mm (4") COUPLER X 80mm (3") H/T	C4030AL

TYPE	SIZE	PART#
D	50mm (2") COUPLER X 40mm (1-1/2") F BSP	D2015AL
D	80mm (3") COUPLER X 50mm (2") F BSP	D3020AL
D	100mm (4") COUPLER X 80mm (3") F BSP	D4030AL
E	80mm (3") ADAPTOR X 50mm (2") H/T	E3020AL
E	100mm (4") ADAPTOR X 80mm (3") H/T	E4030AL
F	80mm (3") ADAPTOR X 50mm (2") M BSP	F3020AL

## SPOOL COUPLINGS



## Spool Adaptors

SIZE	PART# ALUMINIUM	PART# BRASS	PART# STAINLESS
1" (25mm)	AA100AL	AA100BR	AA100SS
1-1/4" (32mm)	AA125AL	-	-
1-1/2" (40mm)	AA150AL	AA150BR	-
2" (50mm)	AA200AL	AA200BR	AA200SS
3" (80mm)	AA300AL	AA300BR	AA300SS
4" (100mm)	AA400AL	AA400BR	AA400SS
6" (150mm)	AA600AL	-	-

## Reducing Spool Adaptors



SIZE	PART# ALUMINIUM
1-1/2" (40mm) x 2" (50mm)	AA1525AL
2" (50mm) X 2-1/2" (65mm)	AA2025AL
2" (50mm) X 3" (80mm)	AA2030AL
2-1/2" (65mm) X 3" (80mm)	AA2530AL
2-1/2" (65mm) X 4" (100mm)	AA2540AL
3" (80mm) X 4" (100mm)	AA3040AL
4" (100mm) X 6" (150mm)	AA4060AL

## Spool Couplers

SIZE	PART# ALUMINIUM
1-1/2" (40MM)	DD150AL
2" (50MM)	DD200AL
3" (80MM)	DD300AL
4" (100MM)	DD400AL



# SPIRAL TAIL COUPLINGS

## SPIRAL TAIL CAMLOCKS (FOR COMPOSITE HOSE)

### Features:

- cast spiral tail
- fitted with stainless handles and pins
- supplied with safety pins
- NBR seals supplied, EPDM & FKM seals page 14

### TECHNICAL DATA

#### MAXIMUM PRESSURE RATINGS\*

\*based upon liquid media at a temperature of 21°C with a standard NBR seal

Size	15mm	20-50mm	65mm	80mm	100mm
Pressure kPa	1035	1725	1035	1035	1035
Pressure psi	150	250	150	150	150



### Aluminum Type C

SIZE	PART#
1" (25mm)	C100ACT
1-1/4" (32mm)	C125ACT
1-1/2" (40mm)	C150ACT
2" (50mm)	C200ACT
2-1/2" (65mm)	C250ACT
3" (80mm)	C300ACT
4" (100mm)	C400ACT



### Aluminum Type E

SIZE	PART#
1" (25mm)	E100ACT
1-1/4" (32mm)	E125ACT
1-1/2" (40mm)	E150ACT
2" (50mm)	E200ACT
2-1/2" (65mm)	E250ACT
3" (80mm)	E300ACT
4" (100mm)	E400ACT



### Aluminum Male

SIZE	PART#
1" (25mm)	M100ACT
1-1/4" (32mm)	M125ACT
1-1/2" (40mm)	M150ACT
2" (50mm)	M200ACT
2-1/2" (65mm)	M250ACT
3" (80mm)	M300ACT
4" (100mm)	M400ACT

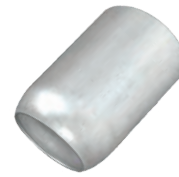

### Aluminum Ferrule

SIZE	PART#
1-1/2" (40mm)	FL150ACT
2" (50mm)	FL200ACT
3" (80mm)	FL300ACT
4" (100mm)	FL400ACT

NB: Contact MCC for correct sizing for your specified hose O.D.



### Stainless Type C

SIZE	PART#
1" (25mm)	C100SCT
1-1/4" (32mm)	C125SCT
1-1/2" (40mm)	C150SCT
2" (50mm)	C200SCT
2-1/2" (65mm)	C250SCT
3" (80mm)	C300SCT
4" (100mm)	C400SCT



### Stainless Type E

SIZE	PART#
1" (25mm)	E100SCT
1-1/4" (32mm)	E125SCT
1-1/2" (40mm)	E150SCT
2" (50mm)	E200SCT
2-1/2" (65mm)	E250SCT
3" (80mm)	E300SCT
4" (100mm)	E400SCT



### Stainless Male

SIZE	PART#
1" (25mm)	M100SCT
1-1/4" (32mm)	M125SCT
1-1/2" (40mm)	M150SCT
2" (50mm)	M200SCT
2-1/2" (65mm)	M250SCT
3" (80mm)	M300SCT
4" (100mm)	M400SCT



### Stainless Ferrule

SIZE	PART#
1" (25mm)	FL100SCT
2" (50mm)	FL200SCT
3" (80mm)	FL300SCT
4" (100mm)	FL400SCT

NB: Contact MCC for correct sizing for your specified hose O.D.

### Composite Hose Ferrule Gasket

SIZE	NBR PART#	NBR LONG PART#	FKM PART#	FKM LONG PART#	EPDM PART#
1" (25mm)	G100NCT	-	G100VCT	-	-
1-1/4" (32mm)	G125NCT	-	G125VCT	-	-
1-1/2" (40mm)	G150NCT	-	G150VCT	-	-
2" (50mm)	G200NCT	G200NCT-L	G200VCT	-	G200DECT
2-1/2" (65mm)	G250NCT	-	G250VCT	-	G250DECT
3" (80mm)	G300NCT	G300NCT-L	G300VCT	G300VCT-L	G300DECT
4" (100mm)	G400NCT	G400NCT-L	G400VCT	G400VCT-L	G400DECT



Standard gasket is short unless otherwise specified - See table.

# 'PULL LOCK' & DIN EN 14420-7 (DIN2828)

## STAINLESS STEEL 'PULL LOCK'

### Features:

- fitted with locking stainless handles and pins
- supplied with safety pins
- NBR seals supplied, EPDM & FKM seals page 14

### TECHNICAL DATA

#### MAXIMUM PRESSURE RATINGS\*

\*based upon liquid media at a temperature of 21°C with a standard NBR seal

Size	32-50mm	65mm	80mm	100mm
Pressure kPa	1725	1035	1035	1035
Pressure psi	250	150	150	150



**Type B  
Pull Lock (BSPT)**

SIZE	PART#
1-1/4" (32MM)	B125SSPL
1-1/2" (40MM)	B150SSPL
2" (50MM)	B200SSPL
2-1/2" (65MM)	B250SSPL
3" (80MM)	B300SSPL
4" (100MM)	B400SSPL



**Type C  
Pull Lock**

SIZE	PART#
1-1/4" (32MM)	C125SSPL
1-1/2" (40MM)	C150SSPL
2" (50MM)	C200SSPL
2-1/2" (65MM)	C250SSPL
3" (80MM)	C300SSPL
4" (100MM)	C400SSPL



**Type D  
Pull Lock (BSPP)**

SIZE	PART#
1-1/4" (32MM)	D125SSPL
1-1/2" (40MM)	D150SSPL
2" (50MM)	D200SSPL
2-1/2" (65MM)	D250SSPL
3" (80MM)	D300SSPL
4" (100MM)	D400SSPL



**Type DC  
Pull Lock**

SIZE	PART#
1-1/4" (32MM)	DC125SSPL
1-1/2" (40MM)	DC150SSPL
2" (50MM)	DC200SSPL
2-1/2" (65MM)	DC250SSPL
3" (80MM)	DC300SSPL
4" (100MM)	DC400SSPL

## DIN EN 14420-7 (DIN 2828) STAINLESS STEEL



**Type A  
DIN EN 14420-7  
(BSPP)**

SIZE	PART#
3/4" (20mm)	A75DINSS
1" (25mm)	A100DINSS
1-1/4" (32mm)	A125DINSS
1-1/2" (40mm)	A150DINSS
2" (50mm)	A200DINSS
2-1/2" (65mm)	A250DINSS
3" (80mm)	A300DINSS
4" (100mm)	A400DINSS

C/W PTFE Thread Seal



**Type D  
DIN EN 14420-7  
(BSPP)**

SIZE	PART#
3/4" (20mm)	D75DINSS
1" (25mm)	D100DINSS
1-1/4" (32mm)	D125DINSS
1-1/2" (40mm)	D150DINSS
2" (50mm)	D200DINSS
2-1/2" (65mm)	D250DINSS
3" (80mm)	D300DINSS
4" (100mm)	D400DINSS

C/W PTFE Thread Seal



**Type C  
DIN EN 14420-7  
(Smoothtail)**

SIZE	PART#
1" (25mm)	C100ST
1-1/2" (40mm)	C150ST
2" (50mm)	C200ST
2-1/2" (65mm)	C250ST
3" (80mm)	C300ST
4" (100mm)	C400ST

For Use with DIN 2817 Clamps

Also available to order in Brass [substitute ST suffix with BRST]



**Type E  
DIN EN 14420-7  
(Smoothtail)**

SIZE	PART#
1" (25mm)	E100ST
1-1/2" (40mm)	E150ST
2" (50mm)	E200ST
2-1/2" (65mm)	E250ST
3" (80mm)	E300ST
4" (100mm)	E400ST

# FLANGED, 68°BENDS & DRY DISCONNECT COUPLINGS

## FLANGED COUPLINGS & BENDS

### Adaptor x Table D/E Flange (Undrilled)

SIZE	Aluminium PART#	Brass PART#	Stainless Steel PART#
1" (25mm)	LA100AL	LA100BR	LA100SS
1-1/2" (40mm)	LA150AL	LA150BR	LA150SS
2" (50mm)	LA200AL	LA200BR	LA200SS
3" (80mm)	LA300AL	LA300BR	LA300SS
4" (100mm)	LA400AL	LA400BR	LA400SS
6" (150mm)	LA600AL	LA600BR	LA600SS



### Coupler x Table D/E Flange (Undrilled)

SIZE	Aluminium PART#	Brass PART#	Stainless Steel PART#
1" (25mm)	LD100AL	LD100BR	LD100SS
1-1/2" (40mm)	LD150AL	LD150BR	LD150SS
2" (50mm)	LD200AL	LD200BR	LD200SS
3" (80mm)	LD300AL	LD300BR	LD300SS
4" (100mm)	LD400AL	LD400BR	LD400SS
6" (150mm)	LD600AL	LD600BR	LD600SS



### Bend 68° Camlock

SIZE	Aluminium PART#	Brass PART#	Stainless Steel PART#
1-1/2" (40mm)	BC100AL	BC100BR	BC100SS
2" (50mm)	BC150AL	BC150BR	BC150SS
3" (80mm)	BC200AL	BC200BR	BC200SS
4" (100mm)	BC300AL	BC300BR	BC300SS
6" (150mm)	BC400AL	BC400BR	BC400SS



## DRY DISCONNECT COUPLINGS

### Aluminium Cam Coupling Dry Disconnect

SIZE	PART#
2" (50mm)	D200DT

#### Features:

- Supplied as a complete set comprising of:
  - 2" adaptor + special coupler with ball valve shut off.
- Provides dry disconnect action when placed in the closed position.
- Acts as an actuator mechanism for 'Kamvalok' style adaptors.
- Quick disconnect cam & groove style.
- Fully interchangeable with 'Kamvalok' style units.

## CAMLOCK GASKETS &amp; SPARES

## Gaskets

SIZE	NBR PART#	FKM PART#	EPDM PART#
1/2" (15MM)	50B	50V	50E
3/4" (20MM)	75B	75V	75E
1" (25MM)	100B	100V	100E
1-1/4" (32MM)	125B	125V	125E
1-1/2" (40MM)	150B	150V	150E
2" (50MM)	200B	200V	200E
2-1/2" (65MM)	250B	250V	250E
3" (80MM)	300B	300V	300E
4" (100MM)	400B	400V	400E
5" (125MM)	500B	500V	500E
6" (150MM)	600B	600V	600E

Other sealing materials available upon request.



## Camlock Handle Assemblies

SIZE	STAINLESS HANDLE PART#	BRASS HANDLE PART#	STAINLESS PIN PART#	STAINLESS RING PART#
3/4" (20mm)	SH75	BH75	SP75	
1" (25mm)	SH100	BH100	SP100	
1-1/4" - 2-1/2" (32mm - 65mm)	SH200	BH200	SP200	
3" - 5" (80mm - 125mm)	SH300	BH300	SP300	
6" (150mm)	SH600	BH600	SP600	
8" (200mm)	-		SP800	
3/4" - 2-1/2" (20mm - 65mm)	-			SSR200
3" - 8" (80mm - 200mm)				SSR300



## Chain &amp; Rings

## Stainless Steel

PART#
SS12CH



## Locking Pin

## Steel

PART#
CGP



# MALLEABLE IRON/STEEL MORTAR COUPLINGS

NOT INTERCHANGEABLE WITH STANDARD CAM AND GROOVE COUPLINGS

## Features:

- Working Pressure 50 Bar
- Couplings of malleable iron/steel, zinc plated and yellow chromated
- Turned stem profile for perfect fit of the hose (On request according to drawing or hose sample)
- TÜV-inspected
- NOTE: Only same type-size and same system interchangeable!
- For mortar and concrete lines on pumps, spraying-devices, plastering machines a.o.



System 22  
(for all type-sizes)



System 23,5  
(only type-sizes 35 and 50!)



## Couplings with Hose Stem

HOSE ID	SYSTEM 22 TYPE NO.	SYSTEM 23,5 TYPE NO.
25mm	MST 25**	same dimension
25mm	MST-X25	same dimension
35mm	MST 35	MST 35-N
38mm	MST 38/35	MST 38/35-N
42mm	MST 42	same dimension
50mm	MST 50	MST 50-N
65mm	MST 65*	same dimension

### REDUCED BORE

19mm	MST 25/19 R**	same dimension
19mm	MST-X25/19 R	same dimension
25mm	MST 35/25 R	MST 35/25 R-N
35mm	MST 50/35 R	MST 50/35 R-N
42mm	MST 50/42 R	MST 50/42 R-N

## Couplings with Male Thread

THREAD	SYSTEM 22 TYPE NO.	SYSTEM 23,5 TYPE NO.
G 1"	MAG 10/25**	same dimension
G 1"	MAG 10-X25	same dimension
G 1-1/4"	MAG 54/35	MAG 54/35-N
G 1-1/2"	MAG 15/42	same dimension
G 2"	MAG 20/50	MAG 20/50-N
G 2-1/2"	MAG 25/50	MAG 25/50-N



# MALLEABLE IRON/STEEL MORTAR COUPLINGS

NOT INTERCHANGEABLE WITH STANDARD CAM AND GROOVE COUPLINGS



### Couplings with Plug

TYPE-SIZE COUPLING	WITH IDENT.-SIZE	SYSTEM 22 TYPE NO.	SYSTEM 23,5 TYPE NO.
X25	42	MSA-X25/25	same dimension
35	51	MSA 35/X25	MSA 35-N/X25
42	54	MSA 42/35	MSA 42/35-N
50	64	MSA 50/35	MSA 50-N/35-N
50	64	MSA 50/42	MSA 50-N/42



### Plugs with Female Thread

THREAD	TYPE-SIZE	SYSTEM 22 TYPE NO.	SYSTEM 23,5 TYPE NO.
G 1"	25	VIG 10/25	same dimension
G 1"	X25	VIG 10-X25	same dimension
G 1-1/4"	X25	VIG 54-X25	same dimension
G 1"	35	VIG 10/35	VIG 10/35-N
G 1-1/4"	35	VIG 54/35	VIG 54/35-N
G1-1/2"	35	VIG 15/35	VIG 15/35-N
G 2"	35	VIG 20/35	VIG 20/35-N
G1-1/2"	42	VIG 15/42	same dimension
G1-1/4"	50	VIG 54/50	VIG 54/50-N
G1-1/2"	50	VIG 15/50	VIG 15/50-N
G2"	50	VIG 20/50	VIG 20/50-N
G2-1/2"	50	VIG 25/50	VIG 25/50-N
G2-1/2"	65	VIG 25/65*	same dimension



### Plugs with Hose Stem

HOSE ID	TYPE-SIZE	SYSTEM 22 TYPE NO.	SYSTEM 23,5 TYPE NO.
25mm	25	VST 25	same dimension
25mm	X25	VST-X25	same dimension
35mm	35	VST 35	VST 35-N
38mm	35	VST 38/35	VST 38/35-N
42mm	42	VST 42	same direction
50mm	50	VST 50	VST 50-N
65mm	65	VST 65*	same direction

#### REDUCED BORE

19mm	X25	VST-X25/19 R	same dimension
25mm	35	VST 35/25 R	VST 35/25 R-N
35mm	50	VST 50/35 R	VST 50/35 R-N
42mm	50	VST 50/42 R	VST 50/42 R-N



### Plugs with Male Thread

THREAD	TYPE-SIZE	SYSTEM 22 TYPE NO.	SYSTEM 23,5 TYPE NO.
G 1"	25	VAG 10/25	same direction
G 1"	X25	VAG 10-X25	same direction
G 1-1/4"	35	VAG 54/35	VAG 54/35-N
G 1-1/2"	42	VAG 15/42	same direction
G 2"	50	VAG 20/50	VAG 20/50-N

MILLENNIUM COUPLING COMPANY

“WE WORK UNDER PRESSURE!”

# 02

## EXTERNAL CRIMP COUPLINGS

	Crimp Plain/Weld End & Victaulic Groove Stem	19
	Crimp Male Threaded Stem	20
	Crimp Fixed Flange (ANSI B16.5) Stem	21
	Crimp Fixed Flange (EN 1092-1) Stem	22
	Crimp Lapped Joint Swivel Flange (ANSI B16.5) Stem	23
	Crimp Lapped Joint Swivel Flange (EN 1092-1) Stem	24
	Crimp Couplings for Oilfield & Offshore Service	25
	Crimp Ferrules for 300psi/20bar Applications	26
	Hygienic / Sanitary Crimp Stems	27
	Hygienic / Sanitary Crimp Ferrules	28
	Six Slot Carbon Steel Zinc Plated Ferrules	29
	Six Slot 304 Stainless Steel Ferrules	30



## EXTERNAL CRIMP COUPLINGS & MILLENNIUM ENGINEERING



The Millennium Coupling Company founded in 2000, is a worldwide supplier of hose coupling products. Featured in this catalogue on pages 19-28 is a comprehensive range of MCC external crimp couplings engineered to meet the demanding requirements of industrial and offshore/oilfield service.

These couplings are manufactured to exacting standards by Millennium Engineering in Preston UK.

Millennium Engineering occupies a bespoke 9000 square feet workshop and is currently equipped with 4 CNC Doosan lathes complete with automatic bar feeds and Fanuc controllers.

These machines have capabilities for machining large volume small parts (1/4" BSP upwards) to small volume large parts such as 8", 10" and 12" swage tails and ferrules. Materials machined are carbon and stainless steel in a variety of grades.

Millennium Engineering can also offer sub-contract machining – please contact 1300 853 250 for your requirements.



# CRIMP PLAIN/WELD END & VICTAULIC GROOVE STEM

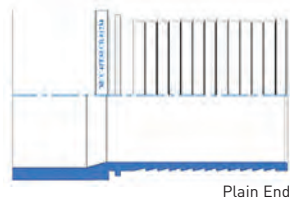

Plain End



Plain End



Victaulic Groove

## Crimp Plain/Weld End & Victaulic Groove Stem

300psi/20bar Maximum Working Pressure

HOSE BORE INCHES	PLAIN/WELD END STEM CARBON STEEL	PLAIN/WELD END STEM STAINLESS STEEL	VICTAULIC GROOVE STEM CARBON STEEL	VICTAULIC GROOVE STEM STAINLESS STEEL
1.00"	1PESECR	1PESECR-S	1VICSECR	1VICSECR-S
1.25"	125PESECR	125PESECR-S	125VICSECR	125VICSECR-S
1.50"	15PESECR	15PESECR-S	15VICSECR	15VICSECR-S
2.00"	2PESECR	2PESECR-S	2VICSECR	2VICSECR-S
2.50"	25PESECR	25PESECR-S	25VICSECR	25VICSECR-S
3.00"	3PESECR	3PESECR-S	3VICSECR	3VICSECR-S
4.00"	4PESECR	4PESECR-S	4VICSECR	4VICSECR-S
5.00"	5PESECR	5PESECR-S	5VICSECR	5VICSECR-S
6.00"	6PESECR	6PESECR-S	6VICSECR	6VICSECR-S
8.00"	8PESECR	8PESECR-S	8VICSECR	8VICSECR-S

### FEATURES

- ▶ Manufactured from carefully selected materials, utilising design calculations to determine that the yield stress is sufficient to ensure that brittle fracture/premature failure will not occur.
- ▶ Supplied with material test reports in accordance with EN:10204 3.1.
- ▶ Carbon Steel Stems are manufactured from Hot Finished Seamless Tube.
- ▶ Plain End Stems are supplied – Natural Finish, suitable for customer to weld.
- ▶ Victaulic Groove Stems are supplied Hexavalent Chromium 6 Free Electro-Plated White/Clear.
- ▶ Stainless Steel Stems are manufactured from grade ASTM 316L/1.4404 Seamless Tube or Hollow Bored Bar and supplied – Natural Finish.
- ▶ Equivalent Internal Expansion fittings are available to order.

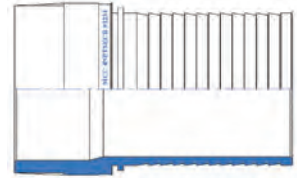

### Crimp Male Threaded Stem

300psi/20bar Maximum Working Pressure

HOSE BORE INCHES	NPT MALE THREAD STEM CARBON STEEL	BSPP MALE THREAD STEM CARBON STEEL	BSPT MALE THREAD STEM CARBON STEEL	NPT MALE THREAD STEM STAINLESS STEEL	BSPP MALE THREAD STEM STAINLESS STEEL	BSPT MALE THREAD STEM STAINLESS STEEL
1.00"	1NPTSECR	1BSPPSECR	1BSPTSECR	1NPTSECR-S	1BSPPSECR-S	1BSPTSECR-S
1.25"	125NPTSECR	125BSPPSECR	125BSPTSECR	125NPTSECR-S	125BSPPSECR-S	125BSPTSECR-S
1.50"	15NPTSECR	150BSPPSECR	150BSPTSECR	15NPTSECR-S	150BSPPSECR-S	150BSPTSECR-S
2.00"	2NPTSECR	2BSPPSECR	2BSPTSECR	2NPTSECR-S	2BSPPSECR-S	2BSPTSECR-S
2.50"	25NPTSECR	25BSPPSECR	25BSPTSECR	25NPTSECR-S	25BSPPSECR-S	25BSPTSECR-S
3.00"	3NPTSECR	3BSPPSECR	3BSPTSECR	3NPTSECR-S	3BSPPSECR-S	3BSPTSECR-S
4.00"	4NPTSECR	4BSPPSECR	4BSPTSECR	4NPTSECR-S	4BSPPSECR-S	4BSPTSECR-S
5.00"	5NPTSECR	5BSPPSECR	5BSPTSECR	5NPTSECR-S	5BSPPSECR-S	5BSPTSECR-S
6.00"	6NPTSECR	6BSPPSECR	6BSPTSECR	6NPTSECR-S	6BSPPSECR-S	6BSPTSECR-S
8.00"	8NPTSECR	8BSPPSECR	8BSPTSECR	8NPTSECR-S	8BSPPSECR-S	8BSPTSECR-S

### FEATURES

- ▶ Manufactured from carefully selected materials, utilising design calculations to determine that the yield stress is sufficient to ensure that brittle fracture/premature failure will not occur.
- ▶ Supplied with material test reports in accordance with EN:10204 3.1.
- ▶ Carbon Steel Stems are manufactured from Hot Finished Seamless Tube and are supplied Hexavalent Chromium 6 Free Electro-Plated White/Clear.
- ▶ Stainless Steel Stems are manufactured from grade ASTM 316L/1.4404 Seamless Tube or Hollow Bored Bar and supplied – Natural Finish.
- ▶ NPT Male Threads are in accordance with ANSI B1.20.1
- ▶ BSPP Male Threads are in accordance with BS EN ISO 228-1
- ▶ BSPT Male Threads are in accordance with BS EN 10226-1 (BS 21)
- ▶ Equivalent internal expansion fittings are available to order.

# CRIMP FIXED FLANGE (ANSI B16.5) STEM

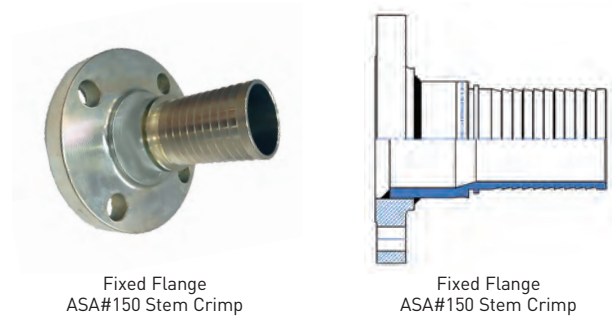

Fixed Flange  
ASA#150 Stem Crimp

Fixed Flange  
ASA#150 Stem Crimp

## Crimp Fixed Flange (ANSI B16.5) Stem

300psi/20bar Maximum Working Pressure (This may be reduced depending on the rating of the Flange selected.)

HOSE BORE INCHES	ASA CLASS#150 STEM CARBON STEEL	ASA CLASS#150 STEM STAINLESS STEEL	ASA CLASS#300 STEM CARBON STEEL	ASA CLASS#300 STEM STAINLESS STEEL
1.00"	1FF150SECR	1FF150SECR-S	1FF300SECR	1FF300SECR-S
1.25"	125FF150SECR	125FF150SECR-S	125FF300SECR	125FF300SECR-S
1.50"	15FF150SECR	15FF150SECR-S	15FF300SECR	15FF300SECR-S
2.00"	2FF150SECR	2FF150SECR-S	2FF300SECR	2FF300SECR-S
2.50"	25FF150SECR	25FF150SECR-S	25FF300SECR	25FF300SECR-S
3.00"	3FF150SECR	3FF150SECR-S	3FF300SECR	3FF300SECR-S
4.00"	4FF150SECR	4FF150SECR-S	4FF300SECR	4FF300SECR-S
5.00"	5FF150SECR	5FF150SECR-S	5FF300SECR	5FF300SECR-S
6.00"	6FF150SECR	6FF150SECR-S	6FF300SECR	6FF300SECR-S
8.00"	8FF150SECR	8FF150SECR-S	8FF300SECR	8FF300SECR-S

## FEATURES

- ▶ Manufactured from carefully selected materials, utilising design calculations to determine that the yield stress is sufficient to ensure that brittle fracture/premature failure will not occur.
- ▶ Supplied with material test reports in accordance with EN:10204 3.1.
- ▶ Carbon Steel Stems are manufactured from Hot Finished Seamless Tube and are supplied Hexavalent Chromium 6 Free Electro-Plated White/Clear.
- ▶ Stainless Steel Stems are manufactured from grade ASTM 316L/1.4404 Seamless Tube or Hollow Bored Bar and supplied – Natural Finish.
- ▶ Flange dimensions in accordance with ANSI/ASME B16.5
- ▶ Flange Materials: ASTM A105N Forged, Rst 37-2 Plate, ASTM A182 F316L Forged, 316L Plate etc.
- ▶ Equivalent internal expansion fittings are available to order.

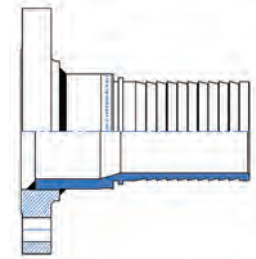
Fixed Flange  
PN16 Stem Crimp**Crimp Fixed Flange (EN1092-1) Stem**

300psi/20bar Maximum Working Pressure (This may be reduced depending on the rating of the Flange selected.)

HOSE BORE INCHES	PN10/16 STEM		PN10 STEM		PN16 STEM	
	CARBON STEEL	STAINLESS STEEL	CARBON STEEL	STAINLESS STEEL	CARBON STEEL	STAINLESS STEEL
1.00"	1FFPN16SECR	1FFPN16SECR-S	—	—	—	—
1.25"	125FFPN16SECR	125FFPN16SECR-S	—	—	—	—
1.50"	15FFPN16SECR	15FFPN16SECR-S	—	—	—	—
2.00"	2FFPN16SECR	2FFPN16SECR-S	—	—	—	—
2.50"	25FFPN16SECR	25FFPN16SECR-S	—	—	—	—
3.00"	3FFPN16SECR	3FFPN16SECR-S	—	—	—	—
4.00"	4FFPN16SECR	4FFPN16SECR-S	—	—	—	—
5.00"	5FFPN16SECR	5FFPN16SECR-S	—	—	—	—
6.00"	6FFPN16SECR	6FFPN16SECR-S	—	—	—	—
8.00"	—	—	8FFPN10SECR	8FFPN10SECR-S	8FFPN16SECR	8FFPN16SECR-S

**FEATURES**

- ▶ Manufactured from carefully selected materials, utilising design calculations to determine that the yield stress is sufficient to ensure that brittle fracture/premature failure will not occur.
- ▶ Supplied with material test reports in accordance with EN:10204 3.1.
- ▶ Carbon Steel Stems are manufactured from Hot Finished Seamless Tube and are supplied Hexavalent Chromium 6 Free Electro-Plated White/Clear.
- ▶ Stainless Steel Stems are manufactured from grade ASTM 316L/1.4404 Seamless Tube or Hollow Bored Bar and supplied – Natural Finish.
- ▶ Flange dimensions in accordance with EN1092-1
- ▶ Flange Materials: S235JRG2 Forged, Rst 37-2 Plate, 316L Forged and Plate or equivalents.
- ▶ Equivalent internal expansion fittings are available to order.

# CRIMP LAPPED JOINT SWIVEL FLANGE (ANSI B16.5) STEM

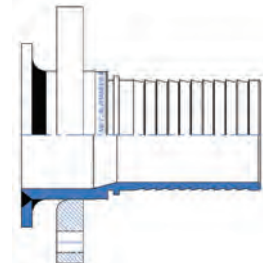

Lap Joint Swivel Flange  
ASA#150 Stem Crimp

## Crimp Lapped Joint Swivel Flange (ANSI B16.5) Stem

300psi/20bar Maximum Working Pressure (This may be reduced depending on the rating of the Flange selected.)

HOSE BORE INCHES	ASA CLASS#150 STEM CARBON STEEL	ASA CLASS#150 STEM STAINLESS STEEL	ASA CLASS#300 STEM CARBON STEEL	ASA CLASS#300 STEM STAINLESS STEEL
1.00"	1LJ150SECR	1LJ150SECR-S	1LJ300SECR	1LJ300SECR-S
1.25"	125LJ150SECR	125LJ150SECR-S	125LJ300SECR	125LJ300SECR-S
1.50"	15LJ150SECR	15LJ150SECR-S	15LJ300SECR	15LJ300SECR-S
2.00"	2LJ150SECR	2LJ150SECR-S	2LJ300SECR	2LJ300SECR-S
2.50"	25LJ150SECR	25LJ150SECR-S	25LJ300SECR	25LJ300SECR-S
3.00"	3LJ150SECR	3LJ150SECR-S	3LJ300SECR	3LJ300SECR-S
4.00"	4LJ150SECR	4LJ150SECR-S	4LJ300SECR	4LJ300SECR-S
5.00"	5LJ150SECR	5LJ150SECR-S	5LJ300SECR	5LJ300SECR-S
6.00"	6LJ150SECR	6LJ150SECR-S	6LJ300SECR	6LJ300SECR-S
8.00"	8LJ150SECR	8LJ150SECR-S	8LJ300SECR	8LJ300SECR-S

## FEATURES

- ▶ Manufactured from carefully selected materials, utilising design calculations to determine that the yield stress is sufficient to ensure that brittle fracture/premature failure will not occur.
- ▶ Supplied with material test reports in accordance with EN:10204 3.1.
- ▶ Carbon Steel Stems are manufactured from Hot Finished Seamless Tube and are supplied Hexavalent Chromium 6 Free Electro-Plated White/Clear.
- ▶ Stainless Steel Stems are manufactured from grade ASTM 316L/1.4404 Seamless Tube or Hollow Bored Bar and supplied – Natural Finish.
- ▶ Flange dimensions in accordance with ANSI/ASME B16.5. Stem end dimensions to ANSI B16.9
- ▶ Flange Materials: ASTM A105N Forged, Rst 37-2 Plate, ASTM A182 F316L Forged, 316L Plate etc.
- ▶ Equivalent internal expansion fittings are available to order.

# CRIMP LAPPED JOINT SWIVEL FLANGE (EN1092-1) STEM

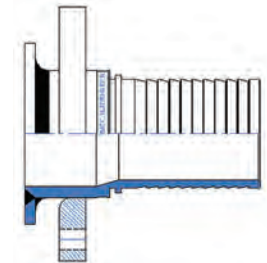

Lap Joint Swivel Flange  
PN16 Stem Crimp

## Crimp Lapped Joint Swivel Flange (EN1092-1) Stem

300psi/20bar Maximum Working Pressure (This may be reduced depending on the rating of the Flange selected.)

HOSE BORE INCHES	PN10/16 STEM		PN10 STEM		PN16 STEM	
	CARBON STEEL	STAINLESS STEEL	CARBON STEEL	STAINLESS STEEL	CARBON STEEL	STAINLESS STEEL
1.00"	1LJPN16SECR	1LJPN16SECR-S	—	—	—	—
1.25"	125LJPN16SECR	125LJPN16SECR-S	—	—	—	—
1.50"	15LJPN16SECR	15LJPN16SECR-S	—	—	—	—
2.00"	2LJPN16SECR	2LJPN16SECR-S	—	—	—	—
2.50"	25LJPN16SECR	25LJPN16SECR-S	—	—	—	—
3.00"	3LJPN16SECR	3LJPN16SECR-S	—	—	—	—
4.00"	4LJPN16SECR	4LJPN16SECR-S	—	—	—	—
5.00"	5LJPN16SECR	5LJPN16SECR-S	—	—	—	—
6.00"	6LJPN16SECR	6LJPN16SECR-S	—	—	—	—
8.00"	—	—	8LJPN10SECR	8LJPN10SECR-S	8LJPN16SECR	8LJPN16SECR-S

### FEATURES

- ▶ Manufactured from carefully selected materials, utilising design calculations to determine that the yield stress is sufficient to ensure that brittle fracture/premature failure will not occur.
- ▶ Supplied with material test reports in accordance with EN:10204 3.1.
- ▶ Carbon Steel Stems are manufactured from Hot Finished Seamless Tube and are supplied Hexavalent Chromium 6 Free Electro-Plated White/Clear.
- ▶ Stainless Steel Stems are manufactured from grade ASTM 316L/1.4404 Seamless Tube or Hollow Bored Bar and supplied – Natural Finish.
- ▶ Flange dimensions in accordance with EN1092-1.
- ▶ Flange Materials: S235JR G2 Forged, Rst 37-2 Plate, 316L Forged and Plate or equivalents.
- ▶ Equivalent internal expansion fittings are available to order.

# CRIMP COUPLINGS FOR OILFIELD & OFFSHORE SERVICE

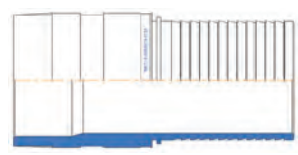

**Hookie Hook Stem x NPT Male Thread for 20 Bar Working Pressure**

HOSE BORE INCHES	STEM CARBON STEEL	STEM STAINLESS STEEL
2.0"	2HHSECR	2HHSECR-S
3.0"	3HHSECR	3HHSECR-S
4.0"	4HHSECR	4HHSECR-S
5.0"	5HHSECR	5HHSECR-S
6.0"	6HHSECR	6HHSECR-S

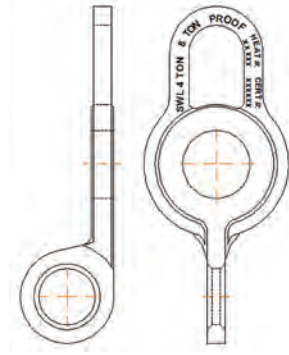

**Hookie Hook Hose Lifter x 4 Ton S.W.L. with Retaining Clamp**

SIZE	CARBON STEEL
2.0"	2HHL
3.0"	3HHL
4.0"	4HHL
5.0"	5HHL
6.0"	6HHL

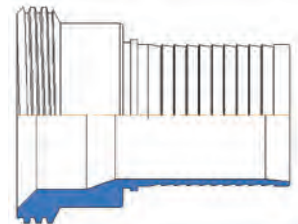

**Integral Female Fig.206 Union Stem 400 psi (27 Bar) Working Pressure Suitable for Frac Hose Applications.**

HOSE BORE INCHES	STEM X FEMALE SUB CARBON STEEL
4.0"	4206FSECR

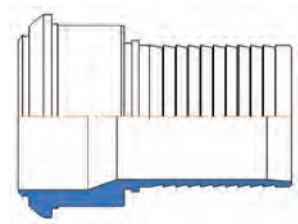

**Integral Male Fig.206 Union Stem 400 psi (27 Bar) Working Pressure Suitable for Frac Hose Applications.**

Supplied with Buna-N O-Ring (Nut available separately)

HOSE BORE INCHES	STEM X MALE SUB CARBON STEEL
4.0"	4206FSECR

**Ferrules for Integral Female & Male Fig.206 Union Stem 400 psi (27 Bar) Working Pressure**

HOSE BORE INCHES	HOSE O.D. MM	PART #	HOSE BORE INCHES	HOSE O.D. MM	PART #
4.0"	114 - 115.5	4UFC114	4.0"	124 - 125.5	4UFC124
4.0"	116 - 117.5	4UFC116	4.0"	126 - 127.5	4UFC126
4.0"	118 - 119.5	4UFC118	4.0"	128 - 129.5	4UFC128
4.0"	120 - 121.5	4UFC120	4.0"	130 - 131.5	4UFC130
4.0"	122 - 123.5	4UFC122	4.0"	132 - 133.5	4UFC132

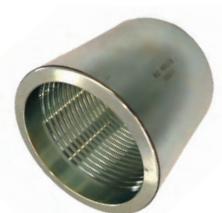

Additional ferrules for different Hose OD's available.

# CRIMP FERRULES FOR 300PSI/20 BAR APPLICATIONS - CARBON STEEL & STAINLESS STEEL

## Crimp Ferrules for 300psi/20 Bar Applications - Carbon Steel & Stainless Steel

For 304 Stainless Steel Ferrules add -S to the Part Number below.  
For 316 Stainless Steel Ferrules add -S316 to the Part Number below

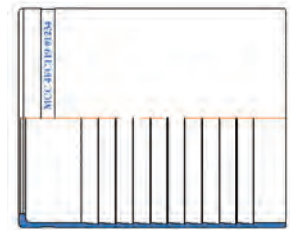

HOSE O.D. (MM)	HOSE I.D. 1.0" DN25	HOSE I.D. 1.25" DN32	HOSE I.D. 1.5" DN40	HOSE I.D. 2.0" DN50	HOSE I.D. 2.5" DN65	HOSE I.D. 3.0" DN75	HOSE I.D. 4.0" DN100	HOSE I.D. 5.0" DN125	HOSE I.D. 6.0" DN150	HOSE I.D. 8.0" DN200
35 to 36.5	1FC35	—	—	—	—	—	—	—	—	—
37 to 38.5	1FC37	—	—	—	—	—	—	—	—	—
39 to 40.5	1FC39	125FC39	—	—	—	—	—	—	—	—
41 to 42.5	—	125FC41	—	—	—	—	—	—	—	—
43 to 44.5	—	125FC43	—	—	—	—	—	—	—	—
45 to 46.5	—	125FC45	—	—	—	—	—	—	—	—
47 to 48.5	—	125FC47	15FC47	—	—	—	—	—	—	—
49 to 50.5	—	—	15FC49	—	—	—	—	—	—	—
51 to 52.5	—	—	15FC51	—	—	—	—	—	—	—
53 to 54.5	—	—	15FC53	—	—	—	—	—	—	—
55 to 56.5	—	—	15FC55	—	—	—	—	—	—	—
57 to 58.5	—	—	15FC57	—	—	—	—	—	—	—
63 to 64.5	—	—	—	2FC63	—	—	—	—	—	—
65 to 66.5	—	—	—	2FC65	—	—	—	—	—	—
67 to 68.5	—	—	—	2FC67	—	—	—	—	—	—
69 to 70.5	—	—	—	2FC69	—	—	—	—	—	—
71 to 72.5	—	—	—	2FC71	—	—	—	—	—	—
73 to 74.5	—	—	—	2FC73	—	—	—	—	—	—
75 to 76.5	—	—	—	2FC75	25FC75	—	—	—	—	—
77 to 78.5	—	—	—	—	25FC77	—	—	—	—	—
79 to 80.5	—	—	—	—	25FC79	—	—	—	—	—
81 to 82.5	—	—	—	—	25FC81	—	—	—	—	—
83 to 84.5	—	—	—	—	25FC83	—	—	—	—	—
85 to 86.5	—	—	—	—	25FC85	—	—	—	—	—
88 to 90	—	—	—	—	—	3FC88	—	—	—	—
90.5 to 92.5	—	—	—	—	—	3FC91	—	—	—	—
93 to 95	—	—	—	—	—	3FC93	—	—	—	—
95.5 to 97.5	—	—	—	—	—	3FC96	—	—	—	—
98 to 100	—	—	—	—	—	3FC99	—	—	—	—
116 to 118.5	—	—	—	—	—	—	4FC116	—	—	—
119 to 121.5	—	—	—	—	—	—	4FC119	—	—	—
122 to 124.5	—	—	—	—	—	—	4FC122	—	—	—
125 to 127.5	—	—	—	—	—	—	4FC125	—	—	—
128 to 129.5	—	—	—	—	—	—	4FC128	—	—	—
142 to 144.5	—	—	—	—	—	—	—	5FC142	—	—
146 to 148.5	—	—	—	—	—	—	—	5FC146	—	—
149 to 151.5	—	—	—	—	—	—	—	5FC149	—	—
152 to 154.5	—	—	—	—	—	—	—	5FC152	—	—
155 to 157.5	—	—	—	—	—	—	—	5FC155	—	—
168 to 170.5	—	—	—	—	—	—	—	—	6FC168	—
171 to 173.5	—	—	—	—	—	—	—	—	6FC171	—
174 to 176.5	—	—	—	—	—	—	—	—	6FC174	—
177 to 179.5	—	—	—	—	—	—	—	—	6FC177	—
180 to 182.5	—	—	—	—	—	—	—	—	6FC180	—
223 to 225.5	—	—	—	—	—	—	—	—	—	8FC223
226 to 228.5	—	—	—	—	—	—	—	—	—	8FC226
229 to 231.5	—	—	—	—	—	—	—	—	—	8FC229
232 to 234.5	—	—	—	—	—	—	—	—	—	8FC232

### FEATURES

- ▶ Manufactured from carefully selected materials, utilising design calculations to determine that the yield stress is sufficient to ensure that brittle fracture/premature failure will not occur.
- ▶ Supplied with material test reports in accordance with EN:10204 3.1.
- ▶ Carbon Steel Ferrules are manufactured from Hot Finished Seamless

Tube and are supplied Hexavalent Chromium 6 Free Electro-Plated White/Clear.

- ▶ Stainless Steel Ferrules are manufactured from grade ASTM 304/304L/1.4301/1.4307 Seamless Tube or Hollow Bored Bar and supplied – Natural Finish.

# CRIMP HYGIENIC STEM STAINLESS STEEL 316/316L



TC  
BS 4825 PART:3



BSM (RJT) MALE  
BS 4825 PART:5



BSM (RJT) FEMALE  
BS 4825 PART:5



BSM (RJT) FEMALE-CIP  
BS 4825 PART:5

## Crimp Hygienic Stem Stainless Steel 316/316L

HOSE BORE INCHES	TC BS 4825 PART:3	IDF FEMALE BS 4825 PART:4	IDF MALE BS 4825 PART:4	BSM (RJT) FEMALE BS 4825 PART:5	BSM (RJT) MALE BS 4825 PART:5	BSM (RJT) FEMALE-CIP BS 4825 PART:5
1.00"	1TCSECR	1IDFFSECR	1IDFMSECR	1RJTFSECR	1RJTMSECR	1CRJTFSECR
1.50"	15TCSECR	15IDFFSECR	15IDFMSECR	15RJTFSECR	15RJTMSECR	15CRJTFSECR
2.00"	2TCSECR	2IDFFSECR	2IDFMSECR	2RJTFSECR	2RJTMSECR	2CRJTFSECR
2.50"	25TCSECR	25IDFFSECR	25IDFMSECR	25RJTFSECR	25RJTMSECR	25CRJTFSECR
3.00"	3TCSECR	3IDFFSECR	3IDFMSECR	3RJTFSECR	3RJTMSECR	3CRJTFSECR
4.00"	4TCSECR	4IDFFSECR	4IDFMSECR	4RJTFSECR	4RJTMSECR	4CRJTFSECR

HOSE BORE INCHES	MACON FEMALE	MACON MALE	DIN FEMALE DIN 11851	DIN MALE DIN 11851	SMS FEMALE 1145	SMS MALE 1146
1.00"	1MACFSECR	1MACMSECR	1DINFSECR	1DINMSECR	1SMSFSECR	1SMSMSECR
1.50"	15MACFSECR	15MACMSECR	15DINFSECR	15DINMSECR	15SMSFSECR	15SMSMSECR
2.00"	20MACFSECR	20MACMSECR	20DINFSECR	20DINMSECR	2SMSSECR	2SMSSECR
2.50"	25MACFSECR	25MACMSECR	25DINFSECR	25DINMSECR	25SMSFSECR	25SMSMSECR
3.00"	3MACFSECR	3MACMSECR	3DINFSECR	3DINMSECR	3SMSFSECR	3SMSMSECR
4.00"	4MACFSECR	4MACMSECR	4DINFSECR	4DINMSECR	4SMSFSECR	4SMSMSECR

HOSE BORE INCHES	BUTT WELD
1.00"	1BWSECR
1.50"	15BWSECR
2.00"	20BWSECR
2.50"	25BWSECR
3.00"	3BWSECR
4.00"	4BWSECR



BUTT WELD



SMS FEMALE  
1145



SMS MALE  
1146

### FEATURES

- ▶ Manufactured from carefully selected materials, utilising design calculations to determine that the yield stress is sufficient to ensure that brittle fracture/premature failure will not occur.
- ▶ Supplied with material test reports in accordance with EN:10204 3.1.
- ▶ Stems are supplied without Seals & Nuts which are available separately.
- ▶ All Sanitary/Hygienic Stainless Steel Stems are manufactured from grade ASTM 316L/1.4404 Seamless Tube, Hollow Bored Bar or alternatively ASTM A350/351M Grade CF8M and supplied in a fully machined condition.
- ▶ Equivalent internal expansion fittings are available to order.

# SANITARY/HYGIENIC FERRULE - STAINLESS STEEL 304/304L

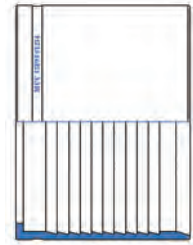

## Crimp Sanitary/Hygienic Ferrule Stainless Steel 304/304L

HOSE O.D. (MM)	HOSE I.D. 1.0"	HOSE I.D. 1.5"	HOSE I.D. 2.0"	HOSE I.D. 2.5"	HOSE I.D. 3.0"	HOSE I.D. 4.0"
35 to 36.5	1SCF35	—	—	—	—	—
37 to 38.5	1SFC37	—	—	—	—	—
39 to 40.5	1SFC39	—	—	—	—	—
41 to 42.5	1SFC41	—	—	—	—	—
47 to 48.5	—	15SFC47	—	—	—	—
49 to 50.5	—	15SFC49	—	—	—	—
51 to 52.5	—	15SFC51	—	—	—	—
53 to 54.5	—	15SFC53	—	—	—	—
55 to 56.5	—	15SFC55	—	—	—	—
63 to 64.5	—	—	2SFC63	—	—	—
65 to 66.5	—	—	2SFC65	—	—	—
67 to 68.5	—	—	2SFC67	—	—	—
69 to 70.5	—	—	2SFC69	—	—	—
75 to 76.5	—	—	—	25SFC75	—	—
77 to 78.5	—	—	—	25SFC77	—	—
79 to 80.5	—	—	—	25SFC79	—	—
83 to 84.5	—	—	—	25SFC83	—	—
88 to 90	—	—	—	—	3SFC88	—
90.5 to 92.5	—	—	—	—	3SFC91	—
93 to 95	—	—	—	—	3SFC93	—
95.5 to 97.5	—	—	—	—	3SFC96	—
98 to 100	—	—	—	—	3SFC99	—
116 to 118.5	—	—	—	—	—	4SFC116
119 to 121.5	—	—	—	—	—	4SFC119
122 to 124.5	—	—	—	—	—	4SFC122
125 to 127.5	—	—	—	—	—	4SFC125
128 to 130.5	—	—	—	—	—	4SFC128

### FEATURES

- ▶ Manufactured from carefully selected materials, utilising design calculations to determine that the yield stress is sufficient to ensure that brittle fracture/premature failure will not occur.
- ▶ Supplied with material test reports in accordance with EN:10204 3.1.
- ▶ Stainless Steel Ferrules are manufactured from grade ASTM 304/304L/1.4301/1.4307 Seamless Tube or Hollow Bored Bar and supplied – Natural Finish.
- ▶ Equivalent internal expansion fittings are available to order.

# CRIMP FERRULES - SIX SLOT CARBON STEEL ZINC PLATED



## Crimp Ferrules Six Slot Carbon Steel Zinc Plated

HOSE OD X ID X WT (MM)	HOSE I.D. 1/2"	HOSE I.D. 3/4"	HOSE I.D. 1"	HOSE I.D. 1 1/4"	HOSE I.D. 1 1/2"	HOSE I.D. 2"	HOSE I.D. 2 1/2"	HOSE I.D. 3"	HOSE I.D. 4"	HOSE I.D. 6"
25.2 X 22.3 X 1.5	CF05014SP	-	-	-	-	-	-	-	-	-
26.8 X 23.8 X 1.5	CF05015SP	-	-	-	-	-	-	-	-	-
28.4 X 25.4 X 1.5	CF05100SP	-	-	-	-	-	-	-	-	-
30 X 27 X 1.5	CF05101SP	-	-	-	-	-	-	-	-	-
31.6 X 28.6 X 1.5	CF05102SP	CF08102SP	-	-	-	-	-	-	-	-
33.2 X 30.2 X 1.5	-	CF08103SP	-	-	-	-	-	-	-	-
34.8 X 31.8 X 1.5	-	CF08104SP	-	-	-	-	-	-	-	-
36.3 X 33.3 X 1.5	-	CF08105SP	CF10105SP	-	-	-	-	-	-	-
37.9 X 34.9 X 1.5	-	CF08106SP	CF10106SP	-	-	-	-	-	-	-
39.5 X 36.5 X 1.5	-	CF08107SP	CF10107SP	-	-	-	-	-	-	-
41.1 X 38.1 X 1.5	-	CF08108SP	CF10108SP	-	-	-	-	-	-	-
42.7 X 39.7 X 1.5	-	-	CF10109SP	-	-	-	-	-	-	-
44.3 X 41.3 X 1.5	-	-	CF10110SP	-	-	-	-	-	-	-
45.9 X 42.9 X 1.5	-	-	CF10111SP	CF13111SP	-	-	-	-	-	-
47.5 X 44.5 X 1.5	-	-	CF10112SP	CF13112SP	-	-	-	-	-	-
49 X 46 X 1.5	-	-	CF10113SP	CF13113SP	-	-	-	-	-	-
50.6 X 47.6 X 1.5	-	-	-	CF13114SP	-	-	-	-	-	-
52.2 X 49.2 X 1.5	-	-	-	CF13115SP	CF15115SP	-	-	-	-	-
53.8 X 50.8 X 1.5	-	-	-	-	CF15200SP	-	-	-	-	-
55.4 X 52.4 X 1.5	-	-	-	-	CF15201SP	-	-	-	-	-
57 X 54 X 1.5	-	-	-	-	CF15202SP	-	-	-	-	-
58.6 X 55.6 X 1.5	-	-	-	-	CF15203SP	-	-	-	-	-
60.2 X 57.2 X 1.5	-	-	-	-	CF15204SP	-	-	-	-	-
61.7 X 58.7 X 1.5	-	-	-	-	CF15205SP	-	-	-	-	-
63.3 X 60.3 X 1.5	-	-	-	-	CF15206SP	-	-	-	-	-
66.5 X 63.5 X 1.5	-	-	-	-	-	CF20208SP	-	-	-	-
68.1 X 65.1 X 1.5	-	-	-	-	-	CF20209SP	-	-	-	-
69.7 X 66.7 X 1.5	-	-	-	-	-	CF20210SP	-	-	-	-
71.3 X 68.3 X 1.5	-	-	-	-	-	CF20211SP	-	-	-	-
72.9 X 69.9 X 1.5	-	-	-	-	-	CF20212SP	-	-	-	-
74.4 X 71.4 X 1.5	-	-	-	-	-	CF20213SP	-	-	-	-
76 X 73 X 1.5	-	-	-	-	-	CF20214SP	-	-	-	-
77.6 X 74.6 X 1.5	-	-	-	-	-	CF20215SP	-	-	-	-
80.8 X 77.8 X 1.5	-	-	-	-	-	-	CF25301SP	-	-	-
82.4 X 79.4 X 1.5	-	-	-	-	-	-	CF25302SP	-	-	-
84 X 81 X 1.5	-	-	-	-	-	-	CF25303SP	-	-	-
85.6 X 82.6 X 1.5	-	-	-	-	-	-	CF25304SP	-	-	-
87.1 X 84.1 X 1.5	-	-	-	-	-	-	CF25305SP	-	-	-
90.3 X 87.3 X 1.5	-	-	-	-	-	-	CF25307SP	-	-	-
95.5 X 90.5 X 2.5	-	-	-	-	-	-	-	CF30309SP	-	-
97.1 X 92.7 X 2.5	-	-	-	-	-	-	-	CF30310SP	-	-
98.7 X 93.7 X 2.5	-	-	-	-	-	-	-	CF30311SP	-	-
100.3 X 95.3 X 2.5	-	-	-	-	-	-	-	CF30312SP	-	-
101.8 X 96.8 X 2.5	-	-	-	-	-	-	-	CF30313SP	-	-
103.4 X 98.4 X 2.5	-	-	-	-	-	-	-	CF30314SP	-	-
105 X 100 X 2.5	-	-	-	-	-	-	-	CF30315SP	-	-
106.6 X 101.6 X 2.5	-	-	-	-	-	-	-	CF30400SP	-	-
120.9 X 115.9 X 2.5	-	-	-	-	-	-	-	-	CF40409SP	-
122.5 X 117.5 X 2.5	-	-	-	-	-	-	-	-	CF40410SP	-
124.1 X 119.1 X 2.5	-	-	-	-	-	-	-	-	CF40411SP	-
125.7 X 120.7 X 2.5	-	-	-	-	-	-	-	-	CF40412SP	-
127.2 X 122.2 X 2.5	-	-	-	-	-	-	-	-	CF40413SP	-
128.8 X 123.8 X 2.5	-	-	-	-	-	-	-	-	CF40414SP	-
130.4 X 125.4 X 2.5	-	-	-	-	-	-	-	-	CF40415SP	-
132 X 127 X 2.5	-	-	-	-	-	-	-	-	CF40500SP	-
133.6 X 128.6 X 2.5	-	-	-	-	-	-	-	-	CF40501SP	-
174.3 X 168.3 X 3	-	-	-	-	-	-	-	-	-	CF60610SP
180.6 X 174.6 X 3	-	-	-	-	-	-	-	-	-	CF60614SP
187 X 181 X 3	-	-	-	-	-	-	-	-	-	CF60702SP
193.3 X 187.3 X 3	-	-	-	-	-	-	-	-	-	CF60706SP

# CRIMP FERRULES - SIX SLOT 304 STAINLESS STEEL

## Six Slot Crimp Ferrules Grade 304 Stainless Steel



HOSE OD X ID X WT (MM)	HOSE I.D. 1/2"	HOSE I.D. 3/4"	HOSE I.D. 1"	HOSE I.D. 1 1/4"	HOSE I.D. 1 1/2"	HOSE I.D. 2"	HOSE I.D. 2 1/2"	HOSE I.D. 3"	HOSE I.D. 4"	HOSE I.D. 6"
25.2 X 22.3 X 1.5	CF05014SS304									
26.8 X 23.8 X 1.5	CF05015SS304									
28.4 X 25.4 X 1.5	CF05100SS304									
30 X 27 X 1.5	CF05101SS304									
31.6 X 28.6 X 1.5	CF05102SS304	CF08102SS304								
33.2 X 30.2 X 1.5		CF08103SS304								
34.8 X 31.8 X 1.5		CF08104SS304								
36.3 X 33.3 X 1.5		CF08105SS304	CF10105SS304							
37.9 X 34.9 X 1.5		CF08106SS304	CF10106SS304							
39.5 X 36.5 X 1.5		CF08107SS304	CF10107SS304							
41.1 X 38.1 X 1.5		CF08108SS304	CF10108SS304							
42.7 X 39.7 X 1.5			CF10109SS304							
44.3 X 41.3 X 1.5			CF10110SS304							
45.9 X 42.9 X 1.5			CF10111SS304	CF13111SS304						
47.5 X 44.5 X 1.5			CF10112SS304	CF13112SS304						
49 X 46 X 1.5			CF10113SS304	CF13113SS304						
50.6 X 47.6 X 1.5				CF13114SS304						
52.2 X 49.2 X 1.5				CF13115SS304	CF15115SS304					
53.8 X 50.8 X 1.5					CF15200SS304					
55.4 X 52.4 X 1.5					CF15201SS304					
57 X 54 X 1.5					CF15202SS304					
58.6 X 55.6 X 1.5					CF15203SS304					
60.2 X 57.2 X 1.5					CF15204SS304					
61.7 X 58.7 X 1.5					CF15205SS304					
63.3 X 60.3 X 1.5					CF15206SS304					
66.5 X 63.5 X 1.5						CF20208SS304				
68.1 X 65.1 X 1.5						CF20209SS304				
69.7 X 66.7 X 1.5						CF20210SS304				
71.3 X 68.3 X 1.5						CF20211SS304				
72.9 X 69.9 X 1.5						CF20212SS304				
74.4 X 71.4 X 1.5						CF20213SS304				
76 X 73 X 1.5						CF20214SS304				
77.6 X 74.6 X 1.5						CF20215SS304				
80.8 X 77.8 X 1.5							CF25301SS304			
82.4 X 79.4 X 1.5							CF25302SS304			
84 X 81 X 1.5							CF25303SS304			
85.6 X 82.6 X 1.5							CF25304SS304			
87.1 X 84.1 X 1.5							CF25305SS304			
90.3 X 87.3 X 1.5							CF25307SS304			
95.5 X 90.5 X 2.5								CF30309SS304		
97.1 X 92.7 X 2.5								CF30310SS304		
98.7 X 93.7 X 2.5								CF30311SS304		
100.3 X 95.3 X 2.5								CF30312SS304		
101.8 X 96.8 X 2.5								CF30313SS304		
103.4 X 98.4 X 2.5								CF30314SS304		
105 X 100 X 2.5								CF30315SS304		
106.6 X 101.6 X 2.5								CF30400SS304		
120.9 X 115.9 X 2.5									CF40409SS304	
122.5 X 117.5 X 2.5									CF40410SS304	
124.1 X 119.1 X 2.5									CF40411SS304	
125.7 X 120.7 X 2.5									CF40412SS304	
127.2 X 122.2 X 2.5									CF40413SS304	
128.8 X 123.8 X 2.5									CF40414SS304	
130.4 X 125.4 X 2.5									CF40415SS304	
132 X 127 X 2.5									CF40500SS304	
133.6 X 128.6 X 2.5									CF40501SS304	
174.3 X 168.3 X 3										CF60610SS304
180.6 X 174.6 X 3										CF60614SS304
187 X 181 X 3										CF60702SS304
193.3 X 187.3 X 3										CF60706SS304

MILLENNIUM COUPLING COMPANY

“WE WORK UNDER PRESSURE!”

# 03

## QUICK COUPLINGS



A Type Claw Couplings

32 -34



S Type Claw Couplings

35 -37



Claw Couplings - Accessories

38



Faster® Quick Release Couplings

39 - 48



High Pressure Air & Steam Couplings & Clamps

49



Quick Connect 'Twist' Hose Couplings

50



# A-TYPE CLAW COUPLINGS



QUICK COUPLINGS

## “BLACK PANTHER” - MILLENNIUM CLAW COUPLINGS 1045 STEEL / DUCTILE IRON BLACK PANTHER FINISH

### FEATURES

- Minimum Burst 1000PSI
- Exceeds Australian Standards AS2554 and AS2660
- Fully interchangeable with market standard
- Safety locking pin provision
- Blade gasket technology PATENT PENDING
- Up to five times greater corrosion resistance
- Batch traceable
- Hex flats
- Claw clamp retaining collar



**A-Type  
Hose End**

SIZE	PART # BLACK PANTHER FINISH
3/8"	BPA010HE
1/2"	BPA015HE
3/4"	BPA020HE
1"	BPA025HE
1 1/4"	BPA032HE



**A-Type  
Male Thread BSPT**

SIZE	PART # BLACK PANTHER FINISH
3/8"	BPA010M
1/2"	BPA015M
3/4"	BPA020M
1"	BPA025M
1 1/4"	BPA032M



**A-Type  
Female Thread BSP**

SIZE	PART # BLACK PANTHER QPQ FINISH
3/8"	BPA010F
1/2"	BPA015F
3/4"	BPA020F
1"	BPA025F
1 1/4"	BPA032F



**CLAMPING SYSTEMS  
- SECTION 05**



**A-Type  
Blank End**

SIZE	PART # BLACK PANTHER FINISH
3/8" - 1 1/4"	BPA1032BE



**A-Type  
Three Way**

SIZE	PART # BLACK PANTHER FINISH
3/8" - 1 1/4"	BPA1032TW



# A-TYPE CLAW COUPLINGS

## MILLENNIUM CLAW COUPLINGS 1045 STEEL / DUCTILE IRON ZINC PLATED FINISH

### FEATURES

- Minimum Burst 1000PSI
- Exceeds Australian Standards AS2554 and AS2660
- Fully interchangeable with market standard
- Safety locking pin provision
- Blade gasket technology <sup>PATENT PENDING</sup>
- Batch traceable
- Hex flats
- Claw clamp retaining collar



**A-Type  
Hose End**

SIZE	PART # ZINC PLATED
3/8"	MCA010HE
1/2"	MCA015HE
3/4"	MCA020HE
1"	MCA025HE
1 1/4"	MCA032HE



**A-Type  
Male Thread**

SIZE	PART # BSPT THREAD	PART # NPT THREAD
3/8"	MCA010M	-
1/2"	MCA015M	MCA015M-N
3/4"	MCA020M	MCA020M-N
1"	MCA025M	MCA025M-N
1 1/4"	MCA032M	-



**A-Type  
Female Thread**

SIZE	PART # BSP THREAD	PART # NPT THREAD
3/8"	MCA010F	-
1/2"	MCA015F	MCA015F-N
3/4"	MCA020F	MCA020F-N
1"	MCA025F	MCA025F-N
1 1/4"	MCA032F	-



**A-Type  
Blank End**

SIZE	PART # ZINC PLATED
3/8" - 1 1/4"	MCA1032BE



**A-Type  
Three Way**

SIZE	PART # ZINC PLATED
3/8" - 1 1/4"	MCA1032TW

# A TYPE - CLAW COUPLINGS

## A TYPE-MILLENNIUM CLAW COUPLINGS 316 STAINLESS STEEL

### FEATURES

- Minimum Burst 1000PSI
- Exceeds AS2554 and AS2660
- Fully interchangeable with market standard.
- Safety locking pin provision.
- Blade gasket technology PATENT PENDING
- Grade 316 Stainless Steel
- Batch traceable
- Hex flats
- Claw clamp retaining collar



Hose End

SIZE	PART # 316 STAINLESS STEEL
1/2"	MCA015HE-S
3/4"	MCA020HE-S
1"	MCA025HE-S



Male Thread  
BSPT

SIZE	PART # 316 STAINLESS STEEL
1/2"	MCA015M-S
3/4"	MCA020M-S
1"	MCA025M-S



Female Thread  
BSP

SIZE	PART # 316 STAINLESS STEEL
1/2"	MCA015F-S
3/4"	MCA020F-S
1"	MCA025F-S



CENTRE PUNCH CLAMPS  
- PAGE 64



# S TYPE - CLAW COUPLINGS

## “BLACK PANTHER” - MILLENNIUM CLAW COUPLINGS 1045 STEEL / DUCTILE IRON BLACK PANTHER FINISH

### FEATURES

- Minimum Burst 1000PSI
- Exceeds Australian Standards AS2554 and AS2660
- Fully interchangeable with market standard
- Safety locking pin provision
- Blade gasket technology <sup>PATENT PENDING</sup>
- Up to five times greater corrosion resistance
- Batch traceable
- Hex flats
- Claw clamp retaining collar



Male Thread BSPT

Female Thread BSP

### Hose End

SIZE	PART # BLACK PANTHER FINISH	IMAGE REF#
3/8"	BPS010HE	S
1/2"	BPS015HE	S
3/4"	BPS020HE	S
1"	BPS025HE	S
1 1/4"	BPS032HE	S
1 1/2"	BPS040HE	M
2"	BPS050HE	M
3"	BPS080HE	L

SIZE	PART # BLACK PANTHER FINISH	IMAGE REF#
3/8"	BPS010M	S
1/2"	BPS015M	S
3/4"	BPS020M	S
1"	BPS025M	S
1 1/4"	BPS032M	S
1 1/2"	BPS040M	M
2"	BPS050M	M
3"	BPS080M	L

SIZE	PART # BLACK PANTHER FINISH	IMAGE REF#
3/8"	BPS010F	S
1/2"	BPS015F	S
3/4"	BPS020F	S
1"	BPS025F	S
1 1/2"	BPS040F	M
2"	BPS050F	M
3"	BPS080F	L

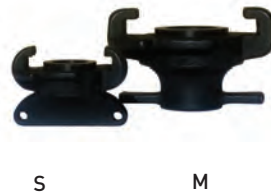

Blank End

SIZE	PART # BLACK PANTHER FINISH	IMAGE REF#
3/8" - 1 1/4"	BPS1032BE	S
1 1/2" - 2"	BPS4050BE	M



Three Way

SIZE	PART # BLACK PANTHER FINISH	IMAGE REF#
3/8" - 1 1/4"	BPS1032TW	S
1 1/2" - 2"	BPS4050TW	M

M - supplied with plug as standard (not pictured)



# S TYPE - CLAW COUPLINGS

## S TYPE-MILLENNIUM CLAW COUPLINGS 1045 STEEL / DUCTILE IRON ZINC PLATED FINISH

### FEATURES

- Minimum Burst 1000PSI
- Exceeds Australian Standards AS2554 and AS2660
- Fully interchangeable with market standard
- Safety locking pin provision
- Blade gasket technology <sup>PATENT PENDING</sup>
- Batch traceable
- Hex flats
- Claw clamp retaining collar



**S-Type  
Hose End**

SIZE	PART # ZINC PLATED	IMAGE REF#
3/8"	MCS010HE	S
1/2"	MCS015HE	S
3/4"	MCS020HE	S
1"	MCS025HE	S
1 1/4"	MCS032HE	S
1 1/2"	MCS040HE	M
2"	MCS050HE	M
3"	MCS080HE	L



**Male Thread  
Zinc Plated**

SIZE	PART # BSPT THREAD	PART # NPT THREAD	IMAGE REF#
3/8"	MCS010M	-	S
1/2"	MCS015M	MCS015M-N	S
3/4"	MCS020M	MCS020M-N	S
1"	MCS025M	MCS025M-N	S
1 1/4"	MCS032M	-	S
1 1/2"	MCS040M	-	M
2"	MCS050M	-	M
3"	MCS080M	-	L



**Female Thread  
Zinc Plated**

SIZE	PART # BSP THREAD	PART # NPT THREAD	IMAGE REF#
3/8"	MCS010F	-	S
1/2"	MCS015F	MCS015F-N	S
3/4"	MCS020F	MCS020F-N	S
1"	MCS025F	MCS025F-N	S
1 1/2"	MCS040F	-	M
2"	MCS050F	-	M
3"	MCS080F	-	L

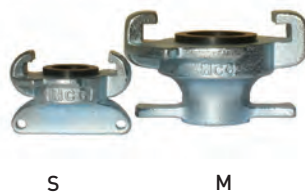

**Blank End**

SIZE	PART # ZINC PLATED	IMAGE REF#
3/8" - 1 1/4"	MCS1032BE	S
1 1/2" - 2"	MCS4050BE	M



**Three Way**

SIZE	PART # ZINC PLATED	IMAGE REF#
3/8" - 1 1/4"	MCS1032TW	S
1 1/2" - 2"	MCS4050TW	M

M - supplied with plug as standard (not pictured)

# S TYPE - CLAW COUPLINGS

## S TYPE-MILLENNIUM CLAW COUPLINGS 316 STAINLESS STEEL

### FEATURES

- Minimum Burst 1000PSI
- Exceeds Australian standards AS2554 and AS2660
- Fully interchangeable with market standard.
- Safety locking pin provision.
- Blade gasket technology PATENT PENDING
- Grade 316 Stainless Steel
- Batch traceable
- Hex flats
- Claw clamp retaining collar



Hose End

SIZE	PART # 316 STAINLESS STEEL	IMAGE REF#
1/2"	MCS015HE-S	S
3/4"	MCS020HE-S	S
1"	MCS025HE-S	S
1 1/2"	MCS040HE-S	M
2"	MCS050HE-S	M



Male Thread  
BSPT

SIZE	PART # 316 STAINLESS STEEL	IMAGE REF#
1/2"	MCS015M-S	S
3/4"	MCS020M-S	S
1"	MCS025M-S	S
1 1/2"	MCS040M-S	M
2"	MCS050M-S	M



Female Thread  
BSP

SIZE	PART # 316 STAINLESS STEEL	IMAGE REF#
1/2"	MCS015F-S	S
3/4"	MCS020F-S	S
1"	MCS025F-S	S
1 1/2"	MCS040F-S	M
2"	MCS050F-S	M



CRIMP FERRULES  
- PAGE 29-30

**A TYPE-MILLENNIUM CLAW COUPLING ACCESSORIES**



**A-Type  
Claw Coupling Gaskets**

SIZE	PART # FKM	PART # NBR
3/8" - 1 1/4"	MCA1032V	MCA1032N



**Safety Locking Pin**

SIZE	PART #
3/8" - 1 1/4"	MCLP

**S TYPE MILLENNIUM CLAW COUPLING ACCESSORIES**



**S-Type  
Gaskets**

SIZE	PART # NBR	PART # EPDM	IMAGE REF#
3/8" - 1 1/4"	MCS1032N	MCS1032E	S
1 1/2" - 2"	MCS4050N	-	M
3"	MCS80N	-	L



**Safety Locking Pin**

SIZE	PART #
3/8" - 3"	MCLP



**WHIPCHECKS  
- PAGE101**

# FASTER® HYDRAULIC QUICK COUPLINGS

## FASTER® FHV SERIES: HIGH PRESSURE FLAT FACE HYDRAULIC QUICK COUPLINGS

### FEATURES

- Connection: Screw together.
- Disconnection: Pull back female safety sleeve and unscrew.
- Shut off: Flat Valve.
- Connect under pressure: YES with male part under residual pressure (35MPa - 5075PSI) without tools.
- Disconnect under pressure: YES
- Interchangeability: FASTER® Internal Standards
- Seals: Polyurethane & NBR (backup ring PTFE)
- Temp: -25°C to +100°C
- Testing: 100,000 cycles at max. rated working pressure disconnected 1,000,000 cycles at max. rated working pressure connected.
- No spillage during connection or disconnection.
- Female part equipped with axial rotation adapters.
- Mating threads heat treated and made to Rd profile.

### TECHNICAL DATA

NOMINAL BODY SIZE		WORKING PRESSURE MPa (PSI) coupler & nipple combination	FLOW RATE l/min (GPM) @ 0.2 MPa pressure drop
mm	inch		
10	3/8"	46 (6650)	32 (9)
15	1/2"	53 (7690)	70(19)
20	3/4"	46 (6650)	120 (32)
25	1"	46 (6650)	200 (53)
40	1 1/2"	40 (5800)	420 (111)
50	2"	35 (5075)	750 (198)

### AVAILABLE UPON REQUEST

- UNF ORB threads
- NPTF Female threads



High Grade Steel with Carbonitrited wearing parts



High Grade Carbon Steel Induction hardened



### Female Couplings (Couplers)

NOMINAL BODY SIZE		PART # HIGH GRADE CARBON STEEL	THREAD SIZE BSP Female
mm	inch		
10	3/8"	FHV0638GASF	3/8"
12.5	1/2"	FHV0812GASF	1/2"
20	3/4"	FHV1234GASF	3/4"
25	1"	FHV161GASF	1"
40	1 1/2"	FHV24112GASF	1 1/2"

### Male Couplings (Nipples)

NOMINAL BODY SIZE		PART # HIGH GRADE CARBON STEEL	THREAD SIZE BSP Female
mm	inch		
10	3/8"	FHV0638GASM	3/8"
12.5	1/2"	FHV0812GASM	1/2"
20	3/4"	FHV1234GASM	3/4"
25	1"	FHV161GASM	1"
40	1 1/2"	FHV24112GASM	1 1/2"

### Dust Protection to Suit

NOMINAL BODY SIZE		PART # DUST PROTECTOR TO SUIT EITHER
mm	inch	
10	3/8"	TM-TF-FHV06
12.5	1/2"	TM-TF-FHV08
20	3/4"	TM-TF-FHV12
25	1"	TM-TF-FHV16
40	1 1/2"	-

## FASTER® FFH SERIES: FLAT FACED HYDRAULIC QUICK COUPLINGS

## FEATURES

- Connection: Push on male coupling.
- Disconnection: Pull back female sleeve.
- Shut off: Flat Face Valve.
- Connect under pressure: NO
- Disconnect under pressure: NO
- Interchangeability: ISO 16028
- Seals: NBR (backup ring PTFE)
- Temp: -25°C to +100°C
- Testing: 100,000 cycles at 133% of rated pressure disconnected, 1,000,000 cycles at 133% of rated pressure connected. Tested according to ISO 7241-2
- No spillage during connection or disconnection



High Grade Carbon Steel with heat treated wear parts

## Female Couplings (Couplers)

NOMINAL BODY SIZE mm inch	PART # BSP THREAD	THREAD SIZE BSP Female	PART # ORB THREAD	THREAD SIZE UNF Female ORB
3 1/8"	FFH0218GASF	1/8"	-	-
6 1/4"	FFH0414GASF	1/4"	-	-
10 3/8"	FFH0638GASF	3/8"	-	-
10 3/8"	FFH0612GASF	1/2"	FFH0612SAEF	3/4"
15 1/2"	FFH0812GASF	1/2"	FFH0812SAEF	3/4"
15 1/2"	-	-	FFH0858SAEF	7/8"
15 1/2"	-	-	FFH0834SAEF	1-1/16"
16 5/8"	FFH1034GASF	3/4"	FFH1034SAEF	1-1/16"
20 3/4"	FFH1234GASF	3/4"	FFH1234SAEF	1-1/16"
25 1"	FFH161GASF	1"	FFH161SAEF	1-5/16"

## Dust Protection to Suit

NOMINAL BODY SIZE mm inch	PART # DUST PROTECTOR TO SUIT NIPPLES	PART # DUST PROTECTOR TO SUIT COUPLERS
6 1/4"	TF2FI14	TM2FI14
10 3/8"	TFF38	TMF38
15 1/2"	TF2FI12	TM2FI12
20 3/4"	TF2FI34	TM2FI34
25 1"	TM2F11	TM2F11

## TECHNICAL DATA

NOMINAL BODY SIZE		WORKING PRESSURE MPa (PSI)	FLOW RATE l/min (GPM)
mm	inch		@ 0.2 MPa pressure drop
3	1/8"	35 (5000)	12 (3.2)
6	1/4"	35 (5000)	25 (6.6)
10	3/8"	35 (5000)	50 (13.2)
15	1/2"	35 (5000)	110 (29)
16	5/8"	35 (5000)	125 (33)
20	3/4"	35 (5000)	160 (42.4)
25	1"	35 (5000)	230 (60.7)

## AVAILABLE UPON REQUEST

- 316 stainless steel
- NPTF Female threads



High Grade Carbon Steel with heat treated wear parts

## Male Couplings (Probes)

NOMINAL BODY SIZE mm inch	PART # BSP THREAD	THREAD SIZE BSP Female	PART # ORB THREAD	THREAD SIZE UNF Female ORB
3 1/8"	FFH0218GASM	1/8"	-	-
6 1/4"	FFH0414GASM	1/4"	-	-
10 3/8"	FFH0638GASM	3/8"	-	-
10 3/8"	FFH0612GASM	1/2"	FFH0612SAEM	3/4"
15 1/2"	FFH0812GASM	1/2"	FFH0812SAEM	3/4"
15 1/2"	-	-	FFH0858SAEM	7/8"
15 1/2"	-	-	FFH0834SAEM	1-1/16"
16 5/8"	FFH1034GASM	3/4"	FFH1034SAEM	1-1/16"
20 3/4"	FFH1234GASM	3/4"	FFH1234SAEM	1-1/16"
25 1"	FFH161GASM	1"	FFH161SAEM	1-5/16"



PVC Dust Protector to suit Coupler



PVC Dust Protector to suit Nipple

# FASTER® HYDRAULIC QUICK COUPLINGS

03

QUICK COUPLINGS

## FASTER® ANV SERIES: ISO-A HYDRAULIC QUICK COUPLINGS

### FEATURES

- Connection: Pull back female sleeve.
- Disconnection: Pull back female sleeve.
- Shut off: Poppet Valve.
- Connect under pressure: NO
- Disconnect under pressure: NO
- Interchangeability: ISO 7241-1 **Part A**
- Seals: Polyurethane and NBR (backup ring PTFE)
- Temp: -25°C to +100°C
- Testing: According to ISO 7241-2

### TECHNICAL DATA

NOMINAL BODY SIZE mm   inch	WORKING PRESSURE MPa (PSI)	FLOW RATE	
		U/min (GPM)	@ 0.2 MPa pressure drop
6 1/4"	50 (7500)	9 (2.4)	
10 3/8"	30 (4500)	30 (7.9)	
15 1/2"	30 (4500)	75 (19.8)	
20 3/4"	30 (4500)	180 (47.6)	
25 1"	25 (3625)	270 (71.4)	
32 1 1/4"	25 (3625)	330 (87.3)	
40 1 1/2"	20 (3000)	450 (119)	
50 2"	15 (2250)	900 (238)	

### AVAILABLE UPON REQUEST

- NPTF or UNF thread fittings



### Female Couplings (Couplers)

NOMINAL BODY SIZE mm inch	PART # HIGH GRADE CARBON STEEL	THREAD SIZE BSP Female
6 1/4"	ANV14GASF	1/4"
10 3/8"	ANV38GASF	3/8"
15 1/2"	ANV12GASF	1/2"
20 3/4"	ANV34GASF	3/4"
25 1"	ANV1GASF	1"
32 1 1/4"	ANV114GASF	1 1/4"
40 1 1/2"	ANV112GASF	1 1/2"
50 2"	ANV2GASF	2"

### Male Couplings (Nipples)

NOMINAL BODY SIZE mm inch	PART # HIGH GRADE CARBON STEEL	THREAD SIZE BSP Female
6 1/4"	ANV14GASM	1/4"
10 3/8"	ANV38GASM	3/8"
15 1/2"	ANV12GASM	1/2"
20 3/4"	ANV34GASM	3/4"
25 1"	ANV1GASM	1"
32 1 1/4"	ANV114GASM	1 1/4"
40 1 1/2"	ANV112GASM	1 1/2"
50 2"	ANV2GASM	2"

### Dust Protection to Suit

NOMINAL BODY SIZE mm inch	PART # DUST PROTECTOR TO SUIT NIPPLES	PART # DUST PROTECTOR TO SUIT COUPLERS
6 1/4"	TFA14	TMA14
10 3/8"	TFA38	TMA38
15 1/2"	TFA12G	TMA12L/G
20 3/4"	TFA34	TMA34
25 1"	TFA1	TMA1



PVC Dust Protector to suit Coupler



PVC Dust Protector to suit Nipple

## FASTER® HNV SERIES: ISO-B HYDRAULIC QUICK COUPLINGS

### FEATURES

- Connection: Pull back female sleeve.
- Disconnection: Pull back female sleeve.
- Shut off: Poppet Valve.
- Connect under pressure: NO
- Disconnect under pressure: NO
- Interchangeability: ISO 7241-1 **Part B**
- Seals: NBR (backup ring PTFE) [Carbon Steel]
- Seals: VITON (backup ring PTFE)[Stainless Steel]
- Temp: -25°C to +125°C [Carbon Steel]
- Temp: -20°C to +200°C [Stainless Steel]
- Testing: According to ISO 7241-2

### TECHNICAL DATA

NOMINAL BODY SIZE		WORKING PRESSURE MPa (PSI)	FLOW RATE
mm	inch		U/min (GPM) @ 0.2 MPa pressure drop
3	1/8"	50 (7500)	5 (1.3)
6	1/4"	45 (6750)	17 (4.5)
10	3/8"	30 (4500)	50 (13.2)
15	1/2"	35 (5250)	75 (19.8)
20	3/4"	25 (3625)	190 (50.2)
25	1"	30 (4500)	270 (71.4)
40	1 1/2"	14 (2100)	750 (198.4)
50	2"	9 (1350)	1600 (423.3)

### AVAILABLE UPON REQUEST

- NPTF or UNF thread fittings



High Grade Carbon Steel with heat treated wear parts

Stainless Steel 316



High Grade Carbon Steel with heat treated wear parts

Stainless Steel 316

### Female Couplings (Couplers)

NOMINAL BODY SIZE		PART # HIGH GRADE CARBON STEEL	PART # STAINLESS STEEL	THREAD SIZE
mm	inch			BSP Female
3	1/8"	HNV18GASF	-	1/8"
6	1/4"	HNV14GASF	HNV14GASF2V	1/4"
10	3/8"	HNV38GASF	HNV38GASF2V	3/8"
15	1/2"	HNV12GASF	HNV12GASF2V	1/2"
20	3/4"	HNV34GASF	HNV34GASF2V	3/4"
25	1"	HNV1GASF	HNV1GASF2V	1"
40	1 1/2"	HNV112GASF	HNV112GASF2V	1 1/2"
50	2"	HNV2GASF	HNV2GASF2V	2"

### Male Couplings (Nipples)

NOMINAL BODY SIZE		PART # HIGH GRADE CARBON STEEL	PART # STAINLESS STEEL	THREAD SIZE
mm	inch			BSP Female
3	1/8"	HNV18GASM	-	1/8"
6	1/4"	HNV14GASM	HNV14GASM2V	1/4"
10	3/8"	HNV38GASM	HNV38GASM2V	3/8"
15	1/2"	HNV12GASM	HNV12GASM2V	1/2"
20	3/4"	HNV34GASM	HNV34GASM2V	3/4"
25	1"	HNV1GASM	HNV1GASM2V	1"
40	1 1/2"	HNV112GASM	HNV112GASM2V	1 1/2"
50	2"	HNV2GASM	HNV2GASM2V	2"

### Dust Protection to Suit

NOMINAL BODY SIZE		PART # DUST PROTECTOR TO SUIT NIPPLES	PART # DUST PROTECTOR TO SUIT COUPLERS
mm	inch		
3	1/8"	TFH18	TMH18
6	1/4"	TFH14	TMH14
10	3/8"	TFH38	TMH38
15	1/2"	TFH12	TMH12
20	3/4"	TFH34	TMH34
25	1"	TFH1	TMH1



PVC Dust Protector to suit Coupler

PVC Dust Protector to suit Nipple

# FASTER® HYDRAULIC QUICK COUPLINGS

03

QUICK COUPLINGS

## FASTER® PVVM SERIES: HIGH PRESSURE SCREW CONNECT HYDRAULIC QUICK COUPLINGS

### FEATURES

- Connection: Screw together.
- Disconnection: Unscrew apart.
- Shut off: Poppet Valve.
- Connect under pressure: YES under residual pressure
- Disconnect under pressure: YES under residual pressure
- Interchangeability: German Market
- Seals: NBR (backup ring PTFE)
- Temp: -25°C to +125°C
- Testing: According to ISO 7241-2

### TECHNICAL DATA

NOMINAL BODY SIZE		WORKING PRESSURE MPa (PSI)	FLOW RATE
mm	inch		l/min (GPM) @ 0.2 MPa pressure drop
6	1/4"	103 (14935)	15 (3.96)
10	3/8"	100 (14500)	20 (5.28)



High Grade Carbon Steel  
with heat treated wear parts



High Grade Carbon Steel  
with heat treated wear parts

### Female Couplings (Couplers)

NOMINAL BODY SIZE		PART # HIGH GRADE CARBON STEEL	THREAD SIZE
mm	inch		NPTF Male
6	1/4"	PVVM1/4NPTF	1/4"
10	3/8"	PVVM3/8NPTF	3/8"

### Male Couplings (Nipples)

NOMINAL BODY SIZE		PART # HIGH GRADE CARBON STEEL	THREAD SIZE
mm	inch		NPTF Female
6	1/4"	PVVM14NPTM	1/4"
10	3/8"	PVVM38NPTM	3/8"

### Dust Protection to Suit

NOMINAL BODY SIZE		PART # DUST PROTECTOR TO SUIT NIPPLES	PART # DUST PROTECTOR TO SUIT COUPLERS
mm	inch		
6	1/4"	TFP14	TMP14
10	3/8"	TFP38	TMP38



Aluminium Dust Protector  
to suit Coupler



Aluminium Dust Protector  
to suit Nipple

## FASTER® VVS SERIES: SCREW CONNECT HYDRAULIC QUICK COUPLINGS

## FEATURES

- Connection: Screw together.
- Disconnection: Unscrew apart.
- Shut off: Poppet Valve.
- Connect under pressure: YES under residual pressure
- Disconnect under pressure: YES under residual pressure
- Interchangeability: FASTER® Internal Standards
- Seals: NBR (backup ring PTFE) [Carbon Steel]
- Seals: VITON (backup ring PTFE)[Stainless Steel]
- Temp: -25°C to +125°C [Carbon Steel]
- Temp: -20°C to +200°C [Stainless Steel]
- Testing: According to ISO 7241-2

## TECHNICAL DATA

NOMINAL BODY SIZE		WORKING PRESSURE MPa (PSI)	FLOW RATE U/min (GPM) @ 0.2 MPa pressure drop
mm	inch		
6	1/4"	80 (11600)	8 (2.1)
10	3/8"	80 (11600)	18 (4.7)
15	1/2"	73 (10600)	40 (10.6)
20	3/4"	73 (10600)	55 (14.7)
25	1"	63 (9150)	100 (26)
32	1 1/4"	60 (8700)	140 (37)
40	1 1/2"	40 (5800)	300 (79)
50	2"	35 (5000)	1000 (264)

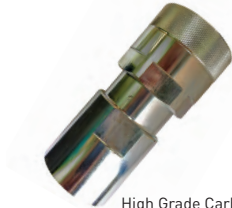
High Grade Carbon Steel  
with heat treated wear parts

Stainless Steel 316

High Grade Carbon Steel  
with heat treated wear parts

Stainless Steel 316

## Female Couplings (Couplers)

NOMINAL BODY SIZE		PART # HIGH GRADE CARBON STEEL	PART # STAINLESS STEEL	THREAD SIZE BSP Female
mm	inch			
6	1/4"	VVS14GASF	VVS14GASF2V	1/4"
10	3/8"	VVS38GASF	VVS38GASF2V	3/8"
15	1/2"	VVS12GASF	VVS12GASF2V	1/2"
20	3/4"	VVS34GASF	VVS34GASF2V	3/4"
25	1"	VVS1GASF	VVS1GASF2V	1"
32	1 1/4"	VVS114GASF	VVS114GASFV2	1 1/4"
40	1 1/2"	VVS112GASF	VVS112GASF2V	1 1/2"
50	2"	VVS2GASF	VVS2GASF2V	2"

## Male Couplings (Nipples)

NOMINAL BODY SIZE		PART # HIGH GRADE CARBON STEEL	PART # STAINLESS STEEL	THREAD SIZE BSP Female
mm	inch			
6	1/4"	VVS14GASM	VVS14GASM2V	1/4"
10	3/8"	VVS38GASM	VVS38GASM2V	3/8"
15	1/2"	VVS12GASM	VVS12GASM2V	1/2"
20	3/4"	VVS34GASM	VVS34GASM2V	3/4"
25	1"	VVS1GASM	VVS1GASM2V	1"
32	1 1/4"	VVS114GASM	VVS114GASM2V	1 1/4"
40	1 1/2"	VVS112GASM	VVS112GASM2V	1 1/2"
50	2"	VVS2GASM	VVS2GASM2V	2"

## Dust Protection to Suit

NOMINAL BODY SIZE		PART # DUST PROTECTOR TO SUIT NIPPLES	PART # DUST PROTECTOR TO SUIT COUPLERS
mm	inch		
6	1/4"	TFV14S	TMV14S
10	3/8"	TFV38S	TMV38S
15	1/2"	TFV12S	TMV12S
20	3/4"	TFV34S	TMV34S
25	1"	TFV1S	TMV1S
32	1 1/4"	TFV114S	TMV114S
40	1 1/2"	TFV112S	TMV112S
50	2"	TFV2S	TMV2S

Aluminium Dust Protector  
to suit CouplerAluminium Dust Protec-  
tor to suit Nipple

# FASTER® HYDRAULIC QUICK COUPLINGS

03

QUICK COUPLINGS

## FASTER® VU SERIES: CHECK VALVES

### FEATURES

- Connection: Screw together.
- Disconnection: Unscrew apart.
- Standard settings: 35 KPa (5 PSI)
- Seals: NBR
- Temp: -25°C to +125°C
- Testing: According to ISO 7241-2

### TECHNICAL DATA

NOMINAL BODY SIZE		WORKING PRESSURE MPa (PSI)	FLOW RATE
mm	inch		U/min (GPM) @ 0.2 MPa pressure drop
6	1/4"	50 (7250)	17 (4.49)
10	3/8"	35 (5075)	68 (17.97)
15	1/2"	35 (5075)	90 (23.78)
20	3/4"	25 (3625)	140 (36.99)
25	1"	25 (3625)	200 (52.84)
32	1 1/4"	25 (3625)	300 (79.26)
40	1 1/2"	20 (2900)	500 (132.10)
50	2"	40 (5800)	700 (184.94)

### AVAILABLE UPON REQUEST

- Stainless Steel NPTF
- NPTF Female thread fittings



NOMINAL BODY SIZE		PART # HIGH GRADE CARBON STEEL	THREAD SIZE
mm	inch		BSP Female
6	1/4"	VU14F14F	1/4"
10	3/8"	VU38F38F	3/8"
15	1/2"	VU12F12F	1/2"
20	3/4"	VU34F34F	3/4"
25	1"	VU1F1F	1"
32	1 1/4"	VU114F114F	1 1/4"
40	1 1/2"	VU112F112F	1 1/2"
50	2"	VU2F2F	2"

### PRESSURE DROP

Data shown in the diagram is indicative

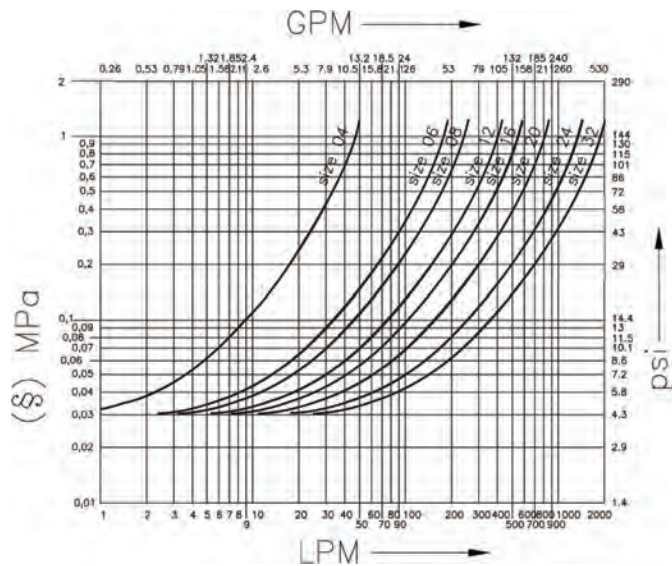

**CERTIFIED EXTERNAL CRIMP FITTINGS - SECTION 02**

## FASTER® DF SERIES: DIAGNOSTIC HYDRAULIC QUICK COUPLINGS

## FEATURES

- Connection: Push on male coupling.
- Disconnection: Pull back female sleeve.
- Shut off: Flat Face Valve.
- Connect under pressure: NO
- Disconnect under pressure: NO
- Interchangeability: ISO 15171-1
- Seals: NBR (backup ring PTFE)
- Temp: -25°C to +125°C
- Testing: According to ISO 7241-2
- No spillage during connection or disconnection

## TECHNICAL DATA

NOMINAL BODY SIZE		WORKING PRESSURE MPa (PSI)	FLOW RATE l/min (GPM) @ 0.2 MPa pressure drop
mm	inch		
6	1/4"	470 (6815)	2 (0.53)

## AVAILABLE UPON REQUEST

- NPTF Male or UNF Female thread fittings



High Grade Carbon Steel with heat treated wear parts

## Female Couplings (Couplers)

NOMINAL BODY SIZE		PART # HIGH GRADE CARBON STEEL	THREAD SIZE
mm	inch		
6	1/4"	DF04-18NPTF	1/8" NPT Female
6	1/4"	DF04-14NPTF	1/4" NPT Female
6	1/4"	DF04-1/14NPTF	1/4" NPT Male
6	1/4"	DF04-14SAEF	7/16" UNF Female



High Grade Carbon Steel with heat treated wear parts

## Male Couplings (Probes)

NOMINAL BODY SIZE		PART # HIGH GRADE CARBON STEEL	THREAD SIZE
mm	inch		
6	1/4"	DF04-18NPTM	1/8" NPT Female
6	1/4"	DF04-14NPTM	1/4" NPT Female
6	1/4"	DF04-1/14NPTM	1/4" NPT Male
6	1/4"	DF04-1/14SAEM	7/16" UNF Male
6	1/4"	DF04-1/14SAEM	9/16" UNF Male
6	1/4"	DF04-1415	M14 X 1.5 Male

## Dust Protection to Suit

NOMINAL BODY SIZE		PART # DUST PROTECTOR TO SUIT NIPPLES
mm	inch	
6	1/4"	TDF04



PVC Dust Protector to suit Nipple

## FASTER® HNV<sub>FR</sub> & OGV<sub>FR</sub> SERIES: BLOW OUT PREVENTION APPLICATIONS

- Introducing the new range of quick-release couplings from FASTER®.
- Independently tested and certified (third part certification by Lloyd's Register) to fully comply with BOP (Blow out Prevention) applications in the Oil and Gas industry.
- Certification verifies that the couplings can withstand fire exposure at 700°C for 5 minutes at full operating pressure without leakage or pressure loss.
- Certification verifies that the couplings are fully compliant with standard API6D
- Easily identifiable by RED colouring on sleeve and male body.
- FASTER® Mate500® coating provides excellent corrosion resistance

### OGV<sub>FR</sub> FEATURES

- Connection: Screw together.
- Disconnection: Unscrew apart.
- Shut off: Poppet Valve.
- Connect under pressure: YES only on one side
- Disconnect under pressure: NO
- Interchangeability: Market Standard



High Grade Carbon Steel with heat treated wear parts

### OGV<sub>FR</sub> Technical Information

NOMINAL BODY SIZE		PART # HIGH GRADE CARBON STEEL COUPLER	PART # HIGH GRADE CARBON STEEL NIPPLE	THREAD SIZE	WORKING PRESSURE (MPa)	CERTIFICATE #
mm	inch					
20	3/4"	OGVFR1234NPSF	OGVFR1234NPSM	3/4" NPS F	34.5	GEN 14-90362
25	1"	OGVFR161NPSF	OGVFR161NPSM	1" NPS F	34.5	GEN 14-90362
32	1 1/4"	OGVFR20114NPTF	OGVFR20114NPTM	1 1/4" NPT F	34.5	GEN 14-90203



High Grade Carbon Steel with heat treated wear parts

### HNV<sub>FR</sub> FEATURES

- Connection: Screw together.
- Disconnection: Unscrew apart.
- Shut off: Poppet Valve.
- Connect under pressure: YES only on one side
- Disconnect under pressure: NO
- Interchangeability: Market Standard

### HNV<sub>FR</sub> Technical Information

NOMINAL BODY SIZE		PART # HIGH GRADE CARBON STEEL COUPLER	PART # HIGH GRADE CARBON STEEL NIPPLE	THREAD SIZE	WORKING PRESSURE (MPa)	CERTIFICATE #
mm	inch					
15	1/2"	HNVFR12NPTF	HNVFR12NPTM	1/2" NPT	21	GEN 14-90362
20	3/4"	HNVFR34NPTF	HNVFR34NPTM	3/4" NPT	21	GEN 14-90362
25	1"	HNVFR1NPTF	HNVFR1NPTM	1" NPT	23	NAO 10 05758

## OGV SERIES: SCREW TO CONNECT WING NUT DESIGN

## FEATURES

- Connection: Screw together.
- Disconnection: Unscrew apart.
- Shut off: Poppet Valve.
- Connect under pressure: YES under residual pressure
- Disconnect under pressure: YES under residual pressure
- Interchangeability: Market Standard [Snaptite 75 Series]
- Seals: Polyurethane and NBR (backup ring PTFE)
- Temp: -25°C to +125°C
- Testing: According to ISO 7241-2.
- Specifically designed for offshore oil and gas industry.
- Faster® Mate500® coating provides excellent corrosion resistance
- Excellent flow capabilities for heavy duty applications due to internal hydrodynamic design.

## TECHNICAL DATA

NOMINAL BODY SIZE		WORKING PRESSURE MPa (PSI)	FLOW RATE l/min (GPM) @ 0.2 MPa pressure drop
mm	inch		
20	3/4"	35 (5000)	151 (40)
25	1"	35 (5000)	227 (60)
32	1 1/4"	35 (5000)	310 (82)
40	1 1/2"	35 (5000)	416 (110)
50	2"	35 (5000)	908 (240)



High Grade Carbon Steel  
with heat treated wear parts



High Grade Carbon Steel  
with heat treated wear parts

## Female Couplings (Couplers)

NOMINAL BODY SIZE		PART # HIGH GRADE CARBON STEEL	THREAD SIZE
mm	inch		
20	3/4"	OGV1234NPSF	3/4" NPS F
25	1"	OGV161NPSF	1" NPS F
32	1 1/4"	OGV20114NPTF	1 1/4" NPT F
40	1 1/2"	OGV24112NPTF	1 1/2" NPT F
50	2"	OGV322NPTF	2" NPT F

## Male Couplings (Probes)

NOMINAL BODY SIZE		PART # HIGH GRADE CARBON STEEL	THREAD SIZE
mm	inch		
20	3/4"	OGV1234NPSM	3/4" NPS F
25	1"	OGV161NPSM	1" NPS F
32	1 1/4"	OGV20114NPTM	1 1/4" NPT F
40	1 1/2"	OGV24112NPTM	1 1/2" NPT F
50	2"	OGV322NPTM	2" NPT F

## Dust Protection to Suit

NOMINAL BODY SIZE		PART # DUST PROTECTOR TO SUIT NIPPLES	PART # DUST PROTECTOR TO SUIT COUPLERS
mm	inch		
20	3/4"	TFOGV12S	TMOGV12S
25	1"	TFOGV16S	TMOGV16S
32	1 1/4"	TFOGV20S	TMOGV20S
40	1 1/2"	TFOGV24S	TMOGV24S
50	2"	TFOGV32S	TMOGV32S

# HIGH PRESSURE AIR & STEAM COUPLINGS

## HIGH PRESSURE AIR & STEAM COUPLINGS

### FEATURES

- Zinc Plated Ductile Iron
- BSP and NPT threads available.
- Air and water applications working pressure 450psi.
- Steam applications working pressure 250psi.



Hose Stem

Stem

PART #	SIZE
FS50	15MM (1/2")
FS75	20MM (3/4")
FS100	25MM (1")
FS125	32MM (1 1/4")
FS150	40MM (1 1/2")
FS200	50MM (2")
FS300	80MM (3")
FS400	100MM (4")

SIZE	PART # Male BSP	PART # Male NPT
15MM (1/2")	MS50	MS50NPT
20MM (3/4")	MS75	MS75NPT
25MM (1")	MS100	MS100NPT
32MM (1 1/4")	MS125	MS125NPT
40MM (1 1/2")	MS150	MS150NPT
50MM (2")	MS200	MS200NPT



Safety Bolt Clamps

PART #	HOSE ID	HOSE OD	STYLE
BC4	15MM (1/2")	24MM - 27MM	2-BOLT
BC5	15MM (1/2")	27MM - 30MM	2-BOLT
BCU9	20MM (3/4")	30MM - 33MM	2-BOLT
BC9	20MM (3/4")	33MM - 38MM	2-BOLT
BC10	20MM (3/4")	38MM - 43MM	2-BOLT
BCU14	25MM (1")	39MM - 43MM	4-BOLT
BC14	25MM (1")	43MM - 49MM	4-BOLT
BC15	25MM (1")	49MM - 54MM	4-BOLT
BC19	32MM (1 1/4")	54MM - 60MM	4-BOLT
BCU24	40MM (1 1/2")	55MM - 60MM	4-BOLT
BCU29	50MM (2")	63MM - 71MM	4-BOLT
BC34	65MM (2 1/2")	89MM - 100MM	4-BOLT
BC35	80MM (3")	97MM - 103MM	4-BOLT



Spud

SIZE	PART # Female BSP	PART # Female NPT
15MM (1/2")	FSP50	FSP50NPT
20MM (3/4")	FSP75	FSP75NPT
25MM (1")	FSP100	FSP100NPT
32MM (1 1/4")	FSP125	FSP125NPT
40MM (1 1/2")	FSP150	FSP150NPT
50MM (2")	FSP200	FSP200NPT
80MM (3")	FSP300	FSP300NPT
100MM (4")	FSP400	FSP400NPT



Wing Nut

PART #	SIZE
WN50	15MM (1/2")
WN75	20MM (3/4")
WN125	32MM (1 1/4")
WN150	40MM (1 1/2")
WN200	50MM (2")
WN300	80MM (3")
WN400	100MM (4")

## QUICK CONNECT 'TWIST' HOSE COUPLINGS

BRASS QUICK COUPLINGS FOR  
LOW PRESSURE WATER AND IRRIGATION SYSTEMS

Hose Tail

PART#	SIZE
GH050	1/2"
GH075	3/4"
GH100	1"
GH125	1 1/4"
GH150	1 1/2"



Male Thread BSPP

PART#	SIZE
GM050	1/2"
GM075	3/4"
GM100	1"
GM125	1 1/4"
GM150	1 1/2"



Female Thread BSPP

PART#	SIZE
GF050	1/2"
GF075	3/4"
GF100	1"
GF125	1.1/4"
GF150	1.1/2"
GF078	7/8"



Blank Cap

PART#	SIZE
GBC	UNIVERSAL



Gasket

PART#	SIZE
GG	UNIVERSAL

## AMERICAN TYPE COMPRESSOR COUPLINGS



Hose Tail

PART#	SIZE
AK038HE	3/8"
AK050HE	1/2"
AK075HE	3/4"
AK100HE	1"



Male Thread NPT

BSP thread available add -B to part #

PART#	SIZE
AK038M	3/8"
AK050M	1/2"
AK075M	3/4"
AK100M	1"



Female Thread NPT

BSP thread available add -B to part #

PART#	SIZE
AK038F	3/8"
AK050F	1/2"
AK075F	3/4"
AK100F	1"



Gasket

PART#	SIZE
AKG	3/8" -1"



Safety Pin

PART#	SIZE
AKP	Universal

MILLENNIUM COUPLING COMPANY

“WE WORK UNDER PRESSURE!”

# 04

## SUCTION & DELIVERY



Tubular Hose Menders & Flanged Hose Tails

52



Combination Nipples & Pin Lugs

53



Lever Lock Couplings

54 -56



Travis Couplings

57



Strainers & Footvalves

58



# TUBULAR HOSE MENDERS & FLANGED HOSE TAILS

## TUBULAR HOSE MENDERS AND FLANGED HOSE TAILS



### Stainless Steel

PART#	SIZE
SMH50	1/2"
SMH58	5/8"
SMH75	3/4"
SMH100	1"
SMH125	1 1/4"
SMH150	1 1/2"
SMH200	2"
SMH250	2 1/2"
SMH300	3"
SMH400	4"
SMH500	5"
SMH600	6"
SMH800	8"
SMH1000	10"
SMH1200	12"



### Stainless Steel

SIZE	TABLE D/E PART#	ANSI150 PART#	PN16 PART#
1"	S100FDE	S100FA	S100FP
1 1/4"	S125FDE	S125FA	S125FP
1 1/2"	S150FDE	S150FA	S150FP
2"	S200FDE	S200FA	S200FP
2 1/2"	S250FDE	S250FA	S250FP
3"	S300FDE	S300FA	S300FP
4"	S400FDE	S400FA	S400FP
6"	S600FDE	S600FA	S600FP

Prices for alternative flange specifications, step sizes and sizes above 4" available upon request. NB – Table D/E same flange up to and including 3". For 4" and above please specify, eg for a 4" Table D use part 400FD. For 4" Table E use part 400FE. Larger sizes of stainless steel, flanged spigots available upon request.



### Mild Steel

SIZE	TABLE D/E PART#	ANSI150 PART#	PN16 PART#
3/4"	75FDE	75FA	75FP
1"	100FDE	100FA	100FP
1 1/4"	125FDE	125FA	125FP
1 1/2"	150FDE	150FA	150FP
2"	200FDE	200FA	200FP
2 1/2"	250FDE	250FA	250FP
3"	300FDE	300FA	300FP
4"	400FDE*	400FA	400FP
5"	500FDE*	500FA	500FP
6"	600FDE*	600FA	600FP
8"	800FDE*	800FA	800FP
10"	1000FDE*	1000FA	1000FP
12"	1200FDE*	1200FA	1200FP



### Mild Steel

PART#	SIZE
HM50	1/2"
HM58	5/8"
HM75	3/4"
HM100	1"
HM125	1 1/4"
HM150	1 1/2"
HM200	2"
HM250	2 1/2"
HM300	3"
HM400	4"
HM500	5"
HM600	6"
HM800	8"
HM1000	10"
HM1200	12"

\*Table D/E same flange up to and including 3". for 4" and above please specify, eg for a 4" Table D use part 400FD. For 4" Table E use part 400FE.

# COMBINATION NIPPLES & PIN LUG COUPLINGS

## COMBINATION NIPPLES



**Threaded Zinc Plated Steel BSP**

PART# ZP Steel	SIZE
KC050	1/2"
KC075	3/4"
KC100	1"
KC125	1 1/4"
KC150	1 1/2"
KC200	2"
KC250	2 1/2"
KC300	3"
KC400	4"
KC500	5"
KC600	6"
KC800	8"
KC1000	10"
KC1200	12"



**Unthreaded Zinc Plated Steel**

PART# ZP Steel	SIZE
PKC050	1/2"
PKC075	3/4"
PKC100	1"*
PKC125	1 1/4"
PKC150	1 1/2"
PKC200	2"
PKC250	2 1/2"
PKC300	3"
PKC400	4"
PKC500	5"
PKC600	6"
PKC800	8"
PKC1000	10"
PKC1200	12"



**Threaded Stainless Steel BSP**

PART# Grade 304	SIZE
KC050S	1/2"
KC075S	3/4"
KC100S	1"
KC125S	1 1/4"
KC150S	1 1/2"
KC200S	2"
KC250S	2 1/2"
KC300S	3"
KC400S	4"
KC500S	5"
KC600S	6"
KC800S	8"



**Unthreaded Stainless Steel**

PART# Grade 304	PART# Grade 316	SIZE
PKC050S	PKC050SS	1/2"
PKC075S	PKC075SS	3/4"
PKC100S	PKC100SS	1"
PKC125S	PKC125SS	1 1/4"
PKC150S	PKC150SS	1 1/2"
PKC200S	PKC200SS	2"
PKC250S	PKC250SS	2 1/2"
PKC300S	PKC300SS	3"
PKC400S	PKC400SS	4"
PKC500S	PKC500SS	5"
PKC600S	PKC600SS	6"
PKC800S	PKC800SS	8"

Note: NPT threads also available

## PIN LUGS



**Polypropylene Pin Lugs BSPP**

PART# Female	PART# Male	SIZE
PLF100	PLM100	1"
PLF125	PLM125	1 1/4"
PLF150	PLM150	1 1/2"
PLF200	PLM200	2"
PLF250	PLM250	2 1/2"
PLF300	PLM300	3"
PLF400	PLM400	4"



**Stainless Steel Pin Lugs BSPP**

PART# Female	PART# Male	SIZE
SLF100	SLM100	1"
SLF125	SLM125	1 1/4"
SLF150	SLM150	1 1/2"
SLF200	SLM200	2"
SLF250	SLM250	2 1/2"
SLF300	SLM300	3"
SLF400	SLM400	4"



**Brass Pin Lugs BSPP**

PART# Female	PART# Male	SIZE
BLF50	BLM50	1/2"
BLF75	BLM75	3/4"
BLF100	BLM100	1"
BLF125	BLM125	1 1/4"
BLF150	BLM150	1 1/2"
BLF200	BLM200	2"
BLF250	BLM250	2 1/2"
BLF300	BLM300	3"
BLF400	BLM400	4"
BLF600	BLM600	6"

## LEVER LOCK TYPE COUPLINGS

### FEATURES

- Water couplings fully interchangeable with other leading manufacturers' types.
- Maximum working pressure 150 psi.



**Complete Sets (Galvanised)**

PART#	SIZE
LLC2	2"
LLC3	3" tail x 3
LLC3.5	3" tail x 3 1/2"
LLC4	4"
LLC5	5"
LLC6	6"
LLC8	8"
LLC10	10"
LLC12	12"



**Male x Hose Tail (Lever ring not included)**

GALVANISED		STAINLESS STEEL	
PART#	SIZE	PART#	SIZE
LLM2	2"	42978	2"
LLM3	3" tail x 3	-	-
LLM3.5	3" tail x 3 1/2"	42987	3" tail x 3 1/2"
LLM4	4"	42981	4"
LLM5	5"	-	-
LLM6	6"	42984	6"
LLM8	8"		
LLM10	10"		
LLM12	12"		



**Lever Ring (Galvanised)**

PART#	SIZE
LLR2	2"
LLR3	3" tail x 3
LLR3.5	3" tail x 3 1/2"
LLR4	4"
LLR5	5"
LLR6	6"
LLR8	8"
LLR10	10"
LLR12	12"



**Female x Hose Tail (Includes 'o' ring)**

GALVANISED		STAINLESS STEEL	
PART#	SIZE	PART #	SIZE
LLF2	2"	42979	2"
LLF3	3" tail x 3	42988	3" tail x 3 1/2"
LLF3.5	3" tail x 3 1/2"	42982	4"
LLF4	4"	42985	6"
LLF5	5"		
LLF6	6"		
LLF8	8"		
LLF10	10"		
LLF12	12"		



**Male Part with Male Thread**

PART#	SIZE
LLM2M	50mm x 2"
*LLM3M	76mm x 3"
LLM3.5M	89mm x 3"
LLM4M	108mm x 4"
LLM5M	133mm x 5"
LLM6M	159mm x 6"

Including handles.  
\* Note this item includes captive closure ring.



**Female Part with Male Thread**

PART#	SIZE
LLF2M	50mm x 2"
LLF3M	76mm x 3"
LLF3.5M	89mm x 3"
LLF4M	108mm x 4"
LLF5M	133mm x 5"
LLF6M	159mm x 6"

Including rubber ring.

**NOTE:** STAINLESS UNITS ARE USED WITH A STANDARD GALVANISED LEVER RING.

# LEVER LOCK COUPLINGS



**Female Socket Part  
Suitable for Welding  
UnGalvanised**

PART#	SIZE
LLF2W	50mm
LLF3W	76mm
LLF3.5W	89mm
LLF4W	108mm
LLF5W	133mm
LLF6W	159mm
LLF8W	194mm



**Male Ball Part  
Suitable for Welding  
UnGalvanised**

PART#	SIZE
LLM2W	50mm
LLM3W	76mm
LLM3.5W	89mm
LLM4W	108mm
LLM5W	133mm
LLM6W	159mm
LLM8W	194mm



**End Cap  
Female Part**

PART#	SIZE
LLF2CAP	50mm
LLF3CAP	76mm
LLF3.5CAP	89mm
LLF4CAP	108mm
LLF5CAP	133mm
LLF6CAP	159mm
LLF8CAP	194mm"

Including rubber ring.



**End Plug Male Part**

PART#	SIZE
LLM2CAP	50mm
LLM3CAP	76mm
LLM3.5CAP	89mm
LLM4CAP	108mm
LLM5CAP	133mm
LLM6CAP	159mm
LLM8CAP	194mm

Including handles.



**Lever Lock  
Rubber 'o' Ring**

PART#	SIZE
LL02	2"
LL03	3" tail x 3"
LL03.5	3" tail x 3 1/2"
LL04	4"
LL05	5"
LL06	6"
LL08	8"
LL010	10"
LL012	12"



**Flanged Adaptors  
Female x Flange**

PART #	SIZE	FLANGE
FFA200D	2"	D/E
FFA300D	3 1/2"	D/E
FFA400D	4"	D/E
FFA600D	6"	D/E
FFA800D	8"	D/E



**Flanged Adaptors  
Male x Flange**

PART #	SIZE	FLANGE
MFA200D	2"	D/E
MFA300D	3 1/2"	D/E
MFA400D	4"	D/E
MFA600D	6"	D
MFA800D	8"	D



**Bend 90°  
male x Female**

PART#	SIZE
LLM2F90	50mm
LLM3F90	76mm
LLM3.5F90	89mm
LLM4F90	108mm
LLM5F90	133mm
LLM6F90	159mm
LLM8F90	194mm

Complete with handles and rubber ring. 45° bend available to special order.



**T-piece Complete  
as Illustrated**

PART#	SIZE FEMALE -2 X MALE
LLF4TMM	108mm
LLF6TMM	159mm



**Female and Male  
Reducer**

PART#	SIZE
LLF3M2	76mm
LLF3.5M3	89mm
LLF4M3.5	108mm
LLF5M4	133mm
LLF6M5	159mm
LLF8M6	194mm



**Female and Male  
Enlarger**

PART#	SIZE
LLF2M3	50 x 76mm
LLF3M3.5	76 x 89mm
LLF3.5M4	89 x 108mm
LLF5M6	133 x 159mm
LLF6M8	159 x 194mm



**Galvanised Steel  
Foot Valve**

PART#	SIZE	CAPACITY Ø M3/HR
LLM2FV	HK 50	50mm 20
LLM3.5FVHK	89	89mm 40
LLM4FV	HK 108	108mm 75
LLF6FV	HK 159	159mm 180



**CLAMPING SYSTEMS  
- SECTION 05**

# TRAVIS STYLE COUPLINGS

## TRAVIS STYLE COUPLINGS - ZINC PLATED STEEL



**Complete Set**

PART #	SIZE
TCS300	3"
TCS400	4"
TCS500	5"
TCS600	6"
TCS800	8"
TCS1000	10"



**Female Coupler**

PART #	SIZE
TCF300	3"
TCF400	4"
TCF500	5"
TCF600	6"
TCF800	8"
TCF1000	10"



**Male Coupler**

PART #	SIZE
TCM300	3"
TCM400	4"
TCM500	5"
TCM600	6"
TCM800	8"
TCM1000	10"



**Ring Lock Clamp**

PART #	SIZE
TCC300	3"
TCC400	4"
TCC500	5"
TCC600	6"
TCC800	8"
TCC1000	10"



**Reducer**

PART #	SIZE
TCR4X3	4"X 3"
TCR5X4	5"X4"
TCR6X4	6"X4"
TCR6X5	6"X5"
TCR10X6	10"X6"
TCR10X8	10"X8"



**Y-Piece**

PART #	SIZE
TCY4X3	4" X 3"
TCY5X4	5"X4"
TCY6X4	6"X4"
TCY6X6	6"X6"
TCY8X4	8"X4"
TCY8X6	8"X6"
TCY8X8	8"X8"



**End Plug**

PART #	SIZE
TCEP300	3"
TCEP400	4"
TCEP500	5"
TCEP600	6"
TCEP800	8"
TCEP1000	10"



**O-Ring**

PART #	SIZE
TCO3	3"
TCO4	4"
TCO5	5"
TCO6	6"
TCO8	8"



**Travis Tube  
1 & 2 Metre Lengths**

PART#1M	PART#2M	SIZE
TCT400X1	TCT400X2	4"
TCT600X1	TCT600X2	6"
TCT800X1	TCT800X2	8"



**Tube with Crown  
1 & 2 Metre Lengths & Crowns**

PART#1M	PART#2M	CROWN	SIZE
TCTC400X1	TCTC400X2	-	4"
TCTC600X1	TCTC600X2	TCCR600	6"
TCTC800X1	TCTC800X2	TCCR800	8"



**Gasket**

PART #	SIZE
TCG3	3"
TCG4	4"
TCG5	5"
TCG6	6"
TCG8	8"



**Stainless Steel Strainers**  
3mm or 5mm Aperture

PART#	SIZE	APERTURE	LENGTH
ST050M5L340	50MM	5MM	340
ST050M3L347	50MM	3MM	347
ST080M3L365	80MM	3MM	365



**Slim Round Hole Strainers**

PART #	SIZE
SHRS150	1 1/2"
SHRS200	2"
SHRS250	2 1/2"
SHRS300	3"
SHRS400	4"
SHRS600	6"



**Round Hole Strainers**

PART #	SIZE
SHR150	1 1/2"
SHR200	2"
SHR250	2 1/2"
SHR300	3"
SHR400	4"
SHR600	6"



**Basket Foot Filters**  
Polyester

PART#	SIZE
9907-734-01	1 1/2" F
9907-733-01	2" F
9907-757-90	3" F



**Foot Valves**  
Threaded  
Female BSPP

PART#	SIZE
FOOT150	1 1/2"
FOOT200	2"
FOOT250	2 1/2"
FOOT300	3"
FOOT400	4"
FOOT600	6"
FOOT800	8"



**Brass Europa Valves**

PART#	SIZE
EU0.375	3/8"
EU0.50	1/2"
EU0.75	3/4"
EU1.00	1"
EU1.25	1 1/4"
EU1.50	1 1/2"
EU2.0	2"
EU2.5	2 1/2"
EU3.0	3"
EU4.0	4"

MILLENNIUM COUPLING COMPANY

“WE WORK UNDER PRESSURE!”

# 05

## CLAMPING SYSTEMS



Superior Clamps

60



Double Bolt Clamps

61



Stainless Steel Strapping

62



Buckles, Clips & Tools

63



Preformed Clamps

64



## SUPERIOR CLAMPS

## FEATURES

- heavy duty clamp for use in agricultural and industrial applications
- bolt (T HEAD GRADE 8.8)
- zinc plated or stainless steel AISI304
- hollow rollers provide uniform torque
- three welding points for increased security on larger sizes
- high band tension
- smooth bore and rolled edges
- unique bridge for optimal hose protection



## Carbon Steel

PART#	SIZE	PART#	SIZE
S19	17-19mm	S91	86-91mm
S22	20-22mm	S97	92-97mm
S25	23-25mm	S103	98-103mm
S28	26-28mm	S112	104-112mm
S31	29-31mm	S121	113-121mm
S35	32-35mm	S130	122-130mm
S39	36-39mm	S139	131-139mm
S43	40-43mm	S148	140-148mm
S47	44-47mm	S161	149-161mm
S51	48-51mm	S174	162-174mm
S55	52-55mm	S187	175-187mm
S59	56-59mm	S200	188-200mm
S63	60-63mm	S213	201-213mm
S67	64-67mm	S226	214-226mm
S73	68-73mm	S239	227-239mm
S79	74-79mm	S252	240-252mm
S85	80-85mm		

## Stainless Steel

PART#	SIZE	PART#	SIZE
S19S	17-19mm	S91S	86-91mm
S22S	20-22mm	S97S	92-97mm
S25S	23-25mm	S103S	98-103mm
S28S	26-28mm	S112S	104-112mm
S31S	29-31mm	S121S	113-121mm
S35S	32-35mm	S130S	122-130mm
S39S	36-39mm	S139S	131-139mm
S43S	40-43mm	S148S	140-148mm
S47S	44-47mm	S161S	149-161mm
S51S	48-51mm	S174S	162-174mm
S55S	52-55mm	S187S	175-187mm
S59S	56-59mm	S200S	188-200mm
S63S	60-63mm	S213S	201-213mm
S67S	64-67mm	S226S	214-226mm
S73S	68-73mm	S239S	227-239mm
S79S	74-79mm	S252S	240-252mm
S85S	80-85mm		

# DOUBLE BOLT CLAMPS



## Double Bolt Hose Clamp with Saddle

### FEATURES

- Zinc Plated
- Adjustable metallic clamp inserts
- Comprehensive size coverage

PART#	HOSE O.D. RANGE
DIDB29	22-29mm
DIDB34	28-34mm
DIDB40	32-40mm
DIDB49	39-49mm
DIDB60	48-60mm
DIDB76	60-76mm
DIDB94	77-94mm
DIDB115	94-115mm
DIDB400	89-97mm
DIDB463	102-109mm
DIDB525	108-125mm
DIDB550	114-133mm
DIDB600	130-145mm
DIDB675	151-165mm
DIDB769	165-192mm
DIDB818	195-208mm
DIDB875	209-225mm
DIDB988	227-250mm
DIDB1125	252-289mm
DIDB1275	284-330mm



## Double Bolt Claw Clamps

### FEATURES

- Zinc Plated
- High Tensile Nuts & Bolts
- Locking claw to engage stem collar
- Metallic adjustable inserts on sizes 15-32mm
- 40-50mm standard with chain restraint provision or available supplied with chain.

PART#	SIZE
DBCC015	15mm
DBCC020	20mm
DBCC025	25mm
DBCC032	32mm
DBCC040	40mm
DBCC050	50mm
DBCC040-C	40mm with chain
DBCC050-C	50mm with chain



**MCC CLAW COUPLINGS  
- PAGES 32-38**



### Economy Stainless Steel Band

PART#	SIZE	THICKNESS	LENGTH
MC133	9.6mm	0.64mm	30.4m
MC134	12.7mm	0.76mm	30.4m
MC128	12.7mm	0.76mm	60.8m
MC135	15.9mm	0.76mm	30.4m
MC136	19.1mm	0.76mm	30.4m

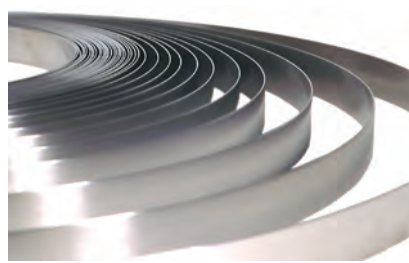

### Grade 201 Stainless Steel Band

PART#	SIZE	THICKNESS	LENGTH
MC202	6.4mm	0.51mm	30.4m
MC203	9.6mm	0.64mm	30.4m
MC204	12.7mm	0.76mm	30.4m
MC205	15.9mm	0.76mm	30.4m
MC206	19.1mm	0.76mm	30.4m

### Grade 201 Stainless Steel Band (with Dispenser)

PART#	SIZE	THICKNESS	LENGTH	DISPENSER COLOUR
MC204B	12.7mm	0.76mm	30.4m	BLUE
MC205G	15.9mm	0.76mm	30.4m	GREEN
MC206R	19.1mm	0.76mm	30.4m	RED



### Grade 201 Stainless Steel Band - Giant

PART#	SIZE	THICKNESS	LENGTH
MC430	19.1mm	1.10mm	30.4m
MC431	25.4mm	1.10mm	30.4m
MC432	31.8mm	1.10mm	30.4m



### Grade 316 Stainless Steel Band

PART#	SIZE	THICKNESS	LENGTH
MC403	9.6mm	0.64mm	30.4m
MC404	12.7mm	0.76mm	30.4m
MC405	15.9mm	0.76mm	30.4m
MC406	19.1mm	0.76mm	30.4m

# MCC STRAPPING - BUCKLES, CLIPS & TOOLS



**Grade 201  
Stainless Steel Buckles**

PART#	BAND SIZE	BOX QTY
MC252	6.4mm	100
MC253	9.6mm	100
MC254	12.7mm	100
MC255	15.9mm	100
MC256	19.1mm	100



**Grade 316  
Stainless Steel Buckles**

PART#	BAND SIZE	BOX QTY
MC453	9.6mm	100
MC454	12.7mm	100
MC455	15.9mm	100
MC456	19.1mm	100



**Grade 201  
Stainless Steel Clips**

PART#	BAND SIZE	BOX QTY
MC154	12.7mm	100
MC155	15.9mm	100
MC156	19.1mm	100



## MCC Centre Punch Tool

### FEATURES

- Use to fit and adjust centre punch clamps before locking under impact of hammer.
- Not to be used on fittings that may crack as a result of impact

PART#	DESCRIPTION
MT3006	MCC Centre Punch Tool



## MCC Screw Action Banding Tool

### FEATURES

- Use to fit various bands and buckles, strapping and free end clamps.
- Heavy Duty Tool
- Easy to use.
- Comes standard with Preformed Clamp Adaptor.

PART#	DESCRIPTION
MC0016	MCC Heavy Duty Screw Action Tool



### J Series Universal Clamps Grade 201 Stainless Steel

#### FEATURES

- Vibration resistant lip wrap lock design.
- Lock is formed by a simple lever movement.
- No hammering or crimping.
- Double wrapped for additional strength.

PART#	CLAMP ID	BAND WIDTH	THICKNESS
MJS240	20mm	6.4mm	0.51mm
MJS242	25mm	6.4mm	0.51mm
MJS241	34mm	6.4mm	0.51mm
MJS252	38mm	6.4mm	0.51mm
MJS253	50mm	6.4mm	0.51mm
MJS256	69mm	6.4mm	0.51mm
MJS244	76mm	6.4mm	0.51mm
MJS257	88mm	6.4mm	0.51mm
MJS201	20mm	9.6mm	0.64mm
MJS243	25mm	9.6mm	0.64mm
MJS202	34mm	9.6mm	0.64mm
MJS245	50mm	9.6mm	0.64mm
MJS246	76mm	9.6mm	0.64mm
MJS255	88mm	9.6mm	0.64mm
MJS203	25mm	12.7mm	0.76mm
MJS204	31mm	12.7mm	0.76mm
MJS236	44mm	12.7mm	0.76mm
MJS230	69mm	12.7mm	0.76mm
MJS249	101mm	12.7mm	0.76mm
MJS205	38mm	15.9mm	0.76mm
MJS206	44mm	15.9mm	0.76mm
MJS207	50mm	15.9mm	0.76mm
MJS208	57mm	15.9mm	0.76mm
MJS209	63mm	15.9mm	0.76mm
MJS210	69mm	19.1mm	0.76mm
MJS211	76mm	19.1mm	0.76mm
MJS212	88mm	19.1mm	0.76mm
MJS213	101mm	19.1mm	0.76mm
MJS214	114mm	19.1mm	0.76mm
MJS215	127mm	19.1mm	0.76mm
MJS216	152mm	19.1mm	0.76mm

### UL Series Clamps Grade 201 Stainless Steel

#### FEATURES

- Thicker buckle offers greater strength.
- Unique lock formed under full tension for maximum tightness.

PART#	CLAMP ID	BAND WIDTH	THICKNESS
MUL227	50mm	19.1mm	0.76mm
MUL210	69mm	19.1mm	0.76mm
MUL211	76mm	19.1mm	0.76mm
MUL212	88mm	19.1mm	0.76mm
MUL213	101mm	19.1mm	0.76mm
MUL215	127mm	19.1mm	0.76mm
MUL270	139mm	19.1mm	0.76mm
MUL216	152mm	19.1mm	0.76mm
MUL217	165mm	19.1mm	0.76mm
MUL219	203mm	19.1mm	0.76mm
MUL228	228mm	19.1mm	0.76mm



### Centre Punch Clamps Grade 201 Stainless Steel

PART#	CLAMP ID	BAND WIDTH	THICKNESS
MCP4S	25mm	15.9mm	0.76mm
MCP5S	32mm	15.9mm	0.76mm
MCP6S	38mm	15.9mm	0.76mm
MCP7S	44mm	15.9mm	0.76mm
MCP8S	51mm	15.9mm	0.76mm
MCP9S	57mm	15.9mm	0.76mm
MCP10S	64mm	15.9mm	0.76mm
MCP11S	70mm	15.9mm	0.76mm
MCP12S	76mm	15.9mm	0.76mm
MCP14S	89mm	15.9mm	0.76mm
MCP16S	102mm	15.9mm	0.76mm
MCP18S	114mm	15.9mm	0.76mm
MCP20S	127mm	15.9mm	0.76mm
MCP24S	152mm	15.9mm	0.76mm



MILLENNIUM COUPLING COMPANY

“WE WORK UNDER PRESSURE!”

# 06

## DIN COUPLINGS



DIN Smooth Tail Couplings & Safety Clamps

66 -67



Storz DIN Suction Couplings [Feuer-Vogel®]

68 -70



Storz Reducers, Blanks & Accessories [Feuer-Vogel®]

71 -72



French Standard Symetric/Guillemain Type

73-74



DIN 28450 Tankwagon

75-76



## DIN 2817 BRASS AND STAINLESS STEEL



**Male Hose Tail  
BSP Brass**

SIZE	PART#
19mm	SMBR19
25mm	SMBR25
32mm	SMBR32
38mm	SMBR38
50mm	SMBR50
65mm	SMBR65
80mm	SMBR80
100mm	SMBR100



**Male Hose Tail  
BSSP  
Stainless Steel**

SIZE	PART#
19mm	SMSS19
25mm	SMSS25
32mm	SMSS32
38mm	SMSS38
50mm	SMSS50
65mm	SMSS65
80mm	SMSS80
100mm	SMSS100



**Female Hose Tail  
BSSP Brass**

SIZE	PART#
19mm	SFBR19
25mm	SFBR25
32mm	SFBR32
38mm	SFBR38
50mm	SFBR50
65mm	SFBR65
80mm	SFBR80
100mm	SFBR100



**Female Hose Tail BSSP  
Stainless Steel**

SIZE	PART#
19mm	SFSS19
25mm	SFSS25
32mm	SFSS32
38mm	SFSS38
50mm	SFSS50
65mm	SFSS65
80mm	SFSS80
100mm	SFSS100

## DIN EN 14420-7 (DIN 2828) STAINLESS STEEL



**Type A  
DIN EN 14420-7  
(BSP)**

SIZE	PART#
3/4"	A75DINSS
1"	A100DINSS
1 1/4"	A125DINSS
1 1/2"	A150DINSS
2"	A200DINSS
2 1/2"	A250DINSS
3"	A300DINSS
4"	A400DINSS

C/W PTFE Thread Seal



**Type D  
DIN EN 14420-7  
(BSP)**

SIZE	PART#
3/4"	D75DINSS
1"	D100DINSS
1 1/4"	D125DINSS
1 1/2"	D150DINSS
2"	D200DINSS
2 1/2"	D250DINSS
3"	D300DINSS
4"	D400DINSS

C/W PTFE Thread Seal



**Type C  
DIN EN 14420-7  
(Smoothtail)**

SIZE	PART#
1"	C100ST
1 1/2"	C150ST
2"	C200ST
2 1/2"	C250ST
3"	C300ST
4"	C400ST

For Use with DIN 2817 Clamps

Also available to order in Brass [substitute ST suffix with BRST]



**Type E  
DIN EN 14420-7  
(Smoothtail)**

SIZE	PART#
1"	E100ST
1 1/2"	E150ST
2"	E200ST
2 1/2"	E250ST
3"	E300ST
4"	E400ST

## DIN SAFETY CLAMPS



## Safety Clamps EN 14420-3 / DIN 2817

Brass	Stainless Steel	Aluminium	DN	Clamp Size	Size Range
DC13BR	DC13SS	DC13AL	13	13*5	22-24
DC19BR	DC19SS	DC19AL	19	19*6	30-33
		DC25X5AL	25	25*5	34-36
DC25BR	DC25SS	DC25AL	25	25*6	36-39
		DC25X8AL	25	25*8	40-43
		DC32X5AL	32	32*5	41-43
DC32BR	DC32SS	DC32AL	32	32*6	43-46
		DC32X8AL	32	32*8	53-56
		DC38X5AL	32	32*5	47-49
DC38BR	DC38SS	DC38AL	38	38*6,5	50-53
		DC38X8AL	38	38*8	53-56
		DC38X10AL	38	38*10	57-60
		DC40X7AL	40	40*7	53-56
		DC40X10AL	40	40*10	58-61
		DC45X7AL	45	45*7	58-61
		DC50AL2	50	50*2	52-54
	DC50X6SS	DC50X6AL	50	50*6	61-63
DC50BR	DC50SS	DC50AL	50	50*8	63-67
	DC50X10SS	DC50X10AL	50	50*10	69-71
	DC63X6SS	DC63X6AL	65	63*6	74-76
DC65BR	DC65SS	DC65AL	65	65*7 / 63*8	78-82
		DC63X10AL	65	63*10	84-87
	DC75X6SS	DC75X6AL	75	75*6	84-86
DC75BR	DC75SS	DC75AL	75	75*8	89-93
		DC75X10AL	75	75*10	94-97
		DC75X12AL	75	75*12	98-101
	DC80X8SS	DC80X8AL	80	80*8	94-97
		DC80X10AL	80	80*10	99-102
		DC90AL	90	90*6,5	104-108
		DC100X6AL	100	100*6	111-115
DC1000BR	DC1000SS	DC1000AL	100	100*8	114-119
		DC100X10AL	100	100*10	118-122
		DC100X12AL	100	100*12	122-126
		DC125X10AL	125	125*10	143-148
		DC125X13AL	125	125*13	149-154
		DC1500AL	150	150*10	178-184
		DC150X13AL	150	150*13	174-180
		DC200X12AL	200	200*12	222-229
		DC200X16AL	200	200*16	230-239

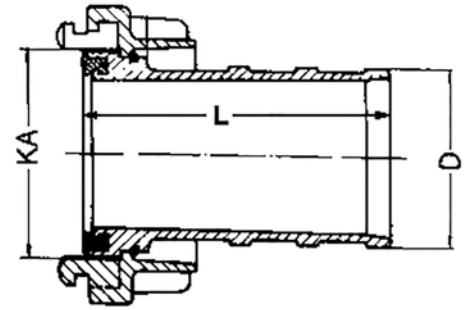

Seal: Nitrile Rubber Black / White



### Aluminium Suction Hose Couplings

STORZ SIZE	KA (mm) Lug	D (mm) Diameter	L (mm) Length	PART # ALUMINIUM	NOTE
25-D	31	21/19	55	12-031019-18	1 GROOVE
25-D	31	25	53	12-031025-10	DIN 14 301
32-D	44	32	70	12-044032-10	
38-D	51	38	90	12-051038-10	
52-C	66	52	90	12-066052-10	DIN 14 321
65	81	38	90	12-081038-10	
65	81	65	95	12-081065-10	
65	81	75	95	12-081075-10	
75-B	89	75	125	12-089075-10	
90	105	90	160	12-105090-10	
100	115	100	150	12-115100-10	
110-A	133	110	170	12-133110-10	DIN 14 323
125	148	125	200	12-148125-10	
150	160	150	180	12-160150-10	
205	220	205	375	12-220205-10	Max. PN 10
250	278	258	400	12-278258-10	Max. PN 10

### AVAILABLE UPON REQUEST

- Other sizes
- Brass STORZ suction hose couplings
- Stainless Steel STORZ suction hose couplings



**J-SERIES CLAMPS**  
- PAGE 64

## STORZ DIN SUCTION COUPLINGS

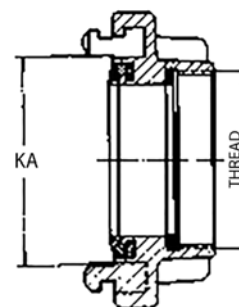

Seal: Nitrile Rubber Black / White



## Aluminium Adaptor with Female Thread BSPP

STORZ SIZE	KA (mm) Lug	THREAD SIZE DIN ISO 228	PART # ALUMINIUM	NOTE
25-D	31	1"	21-031100-10	DIN 14 306
32	44	1 1/4"	21-044125-10	
38	51	1"	21-051100-10	
45	59	2"	21-059200-15	
52-C	66	1 1/2"	21-066150-15	
65	81	1 1/2"	21-081150-10	
65	81	2"	21-081200-10	
65	81	2 1/2"	21-081250-10	
75-B	89	2"	21-089200-15	
75-B	89	2 1/2"	21-089250-15	
75-B	89	3"	21-089300-15	
90	105	3"	21-105300-10	
100	115	4"	21-115400-10	
110-A	133	4 1/2"	21-133450-10	DIN 14 309
125	148	5"	21-148500-10	
150	160	6"	21-160600-10	
165	188	6"	21-188600-10	Max. PN 10
205	220	8"	21-110800-10	Max. PN 10
250	278	10"	12-278258-10	Max. PN 10

## AVAILABLE UPON REQUEST

- Other sizes
- Brass STORZ adaptors with female thread
- Stainless Steel STORZ adaptors with female thread

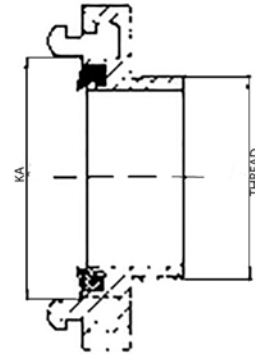
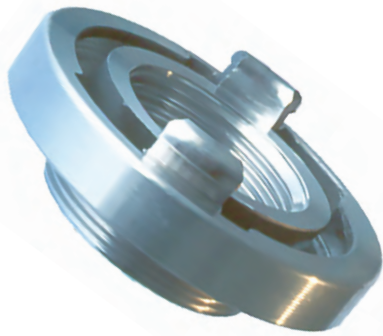

Seal: Nitrile Rubber Black / White



### Aluminium Adaptor with Male Thread BSPP

STORZ SIZE	KA (mm) Lug	THREAD SIZE DIN ISO 228	PART # ALUMINIUM	NOTE
25-D	31	1"	22-031100-10	
32	44	1 1/4"	22-044125-10	
38	51	1"	22-051150-10	
45	59	2"	22-059200-15	
52-C	66	1 1/2"	22-066150-15	
52-C	66	2"	22-066200-15	
52-C	66	2 1/2"	22-066250-15	
65	81	1 1/2"	22-081150-10	
65	81	2"	22-081200-10	
65	81	2 1/2"	22-081250-10	
75-B	89	2"	22-089200-15	
75-B	89	2 1/2"	22-089250-15	
75-B	89	3"	22-089300-15	
90	105	3"	22-105300-10	
100	115	4"	22-115400-10	
110-A	133	4"	22-133400-10	
110-A	133	5"	22-133500-10	
125	148	5"	22-148500-10	with nipple
150	160	6"	22-160600-10	with nipple
165	188	6"	22-188600-10	Max. PN 10 with nipple
205	220	8"	22-110800-10	Max. PN 10 with nipple

### AVAILABLE UPON REQUEST

- Other sizes
- Brass STORZ adaptors with male thread
- Stainless Steel STORZ adaptors with male thread

# STORZ REDUCERS, BLANKS & ACCESSORIES

## STORZ SWIVEL MALE BSP

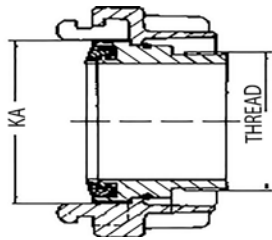

Seal: Nitrile Rubber Black / White

## STORZ REDUCERS (FIXED)

Seal: Nitrile Rubber Black / White

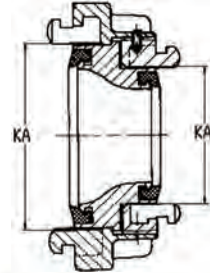

### Aluminium

STORZ SIZE	KA (mm) Lug	THREAD SIZE DIN ISO 228	PART # ALUMINIUM
52-C	66	G 1 1/2"	24-066150-10
52-C	66	G 2"	24-066200-10
65	81	G 1 1/2"	24-081150-10
65	81	G 2"	24-081200-10
65	81	G 2 1/2"	24-081250-10
75-B	89	G 2"	24-089200-10
75-B	89	G 2 1/2"	24-089250-10
75-B	89	G 3"	24-089300-10
90	105	G 3"	24-105300-10
100	115	G 3"	24-115300-10
100	115	G 4"	24-115400-10
110-A	133	G 4"	24-133400-10
110-A	133	G 5"	24-133500-10
125	148	G 4"	24-148400-10
125	148	G 5"	24-148500-10
150	160	G 6"	24-160500-10
150	160	G 6"	24-160600-10

### Aluminium

STORZ TO STORZ SIZE	KA / KA (mm) Lug Space	PART # ALUMINIUM
38 25-D	51 31	35-051031-10
45 25-D	59 31	35-059031-10
52-C 32	66 44	35-066044-10
52-C 38	66 51	35-066051-10
65 38	81 51	35-081051-10
65 45	81 59	35-081059-10
65 52-C	81 66	35-081066-10
75-B 65	89 81	35-089081-10
90 75-B	105 89	35-105089-10
100 65	115 81	35-115081-10
100 75-B	115 89	35-115089-10
100 90	115 105	35-115105-10
110-A 65	133 81	35-133081-10
110-A 90	133 105	35-133105-10
125 100	148 115	35-148115-10
150 100	160 115	35-160115-10
150 125	160 148	35-160148-10

## Storz Coupling Spanners

FOR STORZ SIZE	MATERIAL	PART #
65 / 38	MALLEABLE CAST IRON	71-081051-20
B C	STEEL [PLASTIC HANDLE]	71-089066-50
A B C	STEEL [PLASTIC HANDLE]	71-133066-50
150 / 125	STEEL [PLSTIC HANDLE]	71-160148-50



## BLANK CAP WITH CHAIN

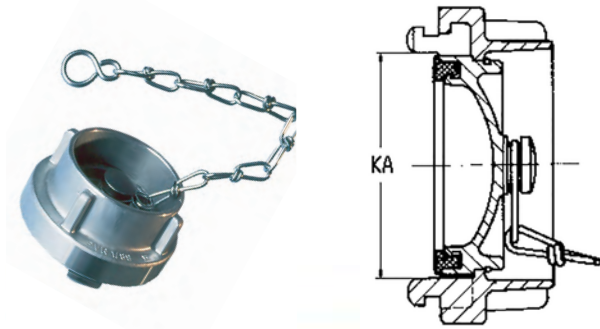

## SUCTION &amp; DELIVERY WASHER



## Aluminium

STORZ SIZE	KA (mm) Lug	PART # ALUMINIUM	NOTE
25-D	31	31-031000-10	DIN 14 310
32	44	31-044000-10	
38	51	31-051000-10	
45	59	31-059000-10	
52-C	66	31-066000-10	DIN 14 311
65	81	31-081000-10	
75-B	89	31-089000-10	DIN 14 312
90	105	31-105000-10	
100	115	31-115000-10	
110-A	133	31-133000-10	DIN 14 313
125	148	31-148000-10	
150	160	31-160000-10	
205	220	31-220000-10	MAX. PN 10 BAR
250	278	31-278000-10	MAX. PN 10 BAR

## Spare Storz Seals

STORZ SIZE	KA (mm) Lug	PART # DELIVERY [BLACK]	PART # SUCTION [WHITE]
45	59	91-001059-00	-
52-C	66	91-001066-00	91-002066-01
65	81	91-001081-00	91-002081-01
75-B	89	91-001089-00	91-002089-01
100	115	91-001115-00	91-002115-01
110-A	133	91-002133-00	91-002133-01
125	148	91-002148-00	91-002148-01
150	160	91-002160-00	91-002160-01

## AVAILABLE UPON REQUEST

- Brass STORZ Blank Caps with Chains
- Stainless Steel STORZ Blank Caps with Chains
- Silicone, Viton & EPDM Seals
- Brass STORZ swivel heads male BSP
- Stainless Steel STORZ swivel heads male BSP
- Aluminium STORZ swivel heads in other sizes
- STORZ spanners in other materials and sizes

## Storz Spare Chain with two Hooks

STORZ SIZE	MATERIAL	PART #
25 to 38	GALVANISED STEEL	91-006031-50
45 to 75	GALVANISED STEEL	91-006066-50
90 to 150	GALVANISED STEEL	91-006133-50
165 to 205	GALVANISED STEEL	91-006220-50



# FRENCH STANDARD SYMETRIQUE/GUILLEMIN TYPE

06

DIN COUPLINGS



## Hose End with Locking Ring

SIZE	HOSE TAIL	ALUMINIUM	STAINLESS STEEL	BRASS	POLYPROPYLENE
DN20	25mm	<i>GH075AL</i>	<i>GH075SS</i>	<i>GH075BR</i>	-
DN25	25mm	<i>GH100AL25</i>	-	-	-
DN25	30mm	<i>GH100AL</i>	<i>GH100SS</i>	<i>GH100BR</i>	-
DN32	32mm	<i>GH125AL32</i>	-	-	-
DN32	35mm	<i>GH125AL</i>	<i>GH125SS</i>	<i>GH125BR</i>	-
DN40	35mm	<i>GH150AL35</i>	-	<i>GH150BR35</i>	<i>GH150PP35</i>
DN40	40mm	<i>GH150AL</i>	<i>GH150SS</i>	<i>GH150BR</i>	<i>GH150PP</i>
DN40	45mm	<i>GH150AL45</i>	<i>GH150SS45</i>	<i>GH150BR45</i>	<i>GH150PP45</i>
DN50	50mm	<i>GH2AL</i>	<i>GH200SS</i>	<i>GH200BR</i>	<i>GH200PP</i>
DN50	55mm	<i>GH200AL55</i>	<i>GH200SS55</i>	<i>GH200BR55</i>	<i>GH200PP55</i>
DN65	65mm	<i>GH250AL</i>	<i>GH250SS</i>	<i>GH250BR</i>	-
DN65	70mm	<i>GH250AL70</i>	<i>GH250SS70</i>	<i>GH250BR70</i>	-
DN80	76mm	<i>GH3AL</i>	<i>GH300SS</i>	<i>GH300BR</i>	<i>GH300PP</i>
DN80	81mm	<i>GH300AL80</i>	<i>GH300SS80</i>	<i>GH300BR80</i>	-
DN80	90mm	<i>GH300AL90</i>	<i>GH300SS90</i>	<i>GH300BR90</i>	<i>GH300PP90</i>
DN100	100mm	<i>GH4AL</i>	<i>GH400SS</i>	-	-
DN100	102mm	<i>GH400AL102</i>	-	<i>GH400BR102</i>	-
DN100	105mm	<i>GH400AL105</i>	<i>GH400SS105</i>	<i>GH400BR105</i>	-
DN100	110mm	<i>GH400AL110</i>	<i>GH400SS110</i>	<i>GH400BR110</i>	<i>GH400PP110</i>
DN125	125mm	<i>GH500AL</i>	-	-	-
DN150	152mm	<i>GH600AL</i>	<i>GH600SS</i>	-	-

# FRENCH STANDARD SYMETRIQUE/GUILLEMIN TYPE



### BSP Male Adaptor with Locking Ring

SIZE	HOSE TAIL	ALUMINIUM	STAINLESS STEEL	BRASS	POLYPROPYLENE
DN20	3/4"	GML075AL	GML075SS	GML075BR	-
DN25	1"	GML100AL	GML100SS	GML100BR	-
DN32	1 1/4"	GML125AL	GML125SS	GML125BR	-
DN40	1 1/2"	GML150AL	GML150SS	GML150BR	GML150PP
DN50	2"	GML2AL	GML2SS	GML200BR	GML200PP
DN65	2 1/2"	GML250AL	GML250SS	GML250BR	-
DN80	2 1/2"	GML300AL65	-	-	-
DN80	3"	GML3AL	GML300SS	GML300BR	GML300PP
DN100	3"	GML300AL80	-	-	-
DN100	4"	GML4AL	GML4SS	GML400BR	GML400PP
DN125	5"	GML500AL	-	-	-
DN150	6"	GML600AL	GML600SS	-	-



### BSP Female Adaptor with Locking Ring

SIZE	HOSE TAIL	ALUMINIUM	STAINLESS STEEL	BRASS	POLYPROPYLENE
DN20	3/4"	GFL075AL	GFL075SS	GFL075BR	-
DN25	1"	GFL100AL	GFL100SS	GFL100BR	-
DN32	1 1/4"	GFL125AL	GFL125SS	GFL125BR	-
DN40	1 1/2"	GFL150AL	GFL150SS	GFL150BR	GFL150PP
DN50	1 1/2"	GFL200AL40	-	-	-
DN50	2"	GFL2AL	GFL2SS	GFL200BR	GFL200PP
DN65	2"	GFL250AL50	-	-	-
DN65	2 1/2"	GFL250AL	GFL250SS	GFL250BR	-
DN80	2 1/2"	GFL300AL65	-	-	-
DN80	3"	GFL300AL	GFL3SS	GFL300BR	GFL300PP
DN100	3"	GFL400AL80	-	-	-
DN100	4"	GFL4AL	GFL4SS	GFL400BR	GFL400PP
DN125	5"	GFL500AL	-	-	-
DN150	4"	GFL600AL100	-	-	-
DN150	6"	GFL600AL	GFL600SS	-	-

## DIN 28450 TANKWAGON



## Coupler Type MK Female BSPP Threaded

Aluminium	Stainless Steel	Brass	Dimension	Thread	Style
	2MKS	2MKB	DN050	G2"	Complete
3MKA	3MKS	3MKB	DN080	G3"	Complete
	4MKS	4MKB	DN100	G4"	Complete
	2MKRS	2MKRB	DN050	G2"	Lever
	3MKRS	3MKRB	DN080	G3"	Lever
	2MKCS	2MKCB	DN050	G2"	Crown
	3MKCS	3MKCB	DN080	G3"	Crown



## Adapter Type VK Female BSPP Threaded

Aluminium	Stainless Steel	Brass	Dimension	Thread
	2VKS	2VKB	DN050	G2"
3VKA	3VKS	3VKB	DN080	G3"
	4VKS	4VKB	DN100	G4"



## Serrated Tail and Collar for Safety Clamps

Stainless Steel	Brass	Dimension	Dimension
2VKSST	2VKBST	DN050	50mm
3VKSST	3VKBST	DN080	76mm
2MKSST	2MKBST	DN050	50mm
3MKSST	3MKBST	DN080	76mm



### Plug MB for VK

Aluminium	Stainless Steel	Brass	Dimension
2MBA	2MBS	2MBB	DN050
3MBA	3MBS	3MBB	DN080
4MBA	4MBS	4MBB	DN100



### Plug and VB for MK

Polypropylene	Aluminium	Stainless Steel	Brass	Dimension
2VBP	2VBA	2VBS	2VBB	DN050
3VBP	3VBA	3VBS	3VBB	DN080
4VBP	4VBA		4VBB	DN100

### Tankwagen Spanner

PART#	Material	Dimension
SGE	Stainless Steel	DN50-100
SGG	Mild Steel	DN65-100



MILLENNIUM COUPLING COMPANY

“WE WORK UNDER PRESSURE!”

# 07

## VALVES



General Purpose & Dual Approved Brass Ball Valves 78 -79



AGA® Approved Brass Ball Valves 79



Stainless Steel Ball Valves 80



Polypropylene Ball Valves 81



Dry Disconnect Couplings with ball valve shut off 81



Butterfly Valves 82



Check Valves 83



Gate Valves, Globe Valve & Strainers 84



Miscellaneous Brass Valves 84



# GENERAL PURPOSE & DUAL APPROVED BRASS BALL VALVES

VALVES

## GENERAL PURPOSE CHROME PLATED



**General Purpose Female x Female**

SIZE	PART#
1/4"	BBV025
3/8"	BBV038
1/2"	BBV050
3/4"	BBV075
1"	BBV100
1 1/4"	BBV125
1 1/2"	BBV150
2"	BBV200
2 1/2"	BBV250
3"	BBV300
4"	BBV400



**General Purpose Male x Female**

SIZE	PART#
1/2"	BBVMF050
3/4"	BBVMF075
1"	BBVMF100
1 1/4"	BBVMF125
1 1/2"	BBVMF150
2"	BBVMF200



**Mini Chrome Plated Female x Female**

SIZE	PART#
1/8"	MBV012
1/4"	MBV025
3/8"	MBV038
1/2"	MBV050
3/4"	MBV075



**Mini Chrome Plated Male x Female**

SIZE	PART#
1/8"	MBVMF012
1/4"	MBVMF025
3/8"	MBVMF038
1/2"	MBVMF050
3/4"	MBVMF075

## DUAL APPROVED - WATERMARK® & AGA®



**Dual Approved Female x Female**

SIZE	PART#
1/4"	BVDA025
3/8"	BVDA038
1/2"	BVDA050
3/4"	BVDA075
1"	BVDA100
1 1/4"	BVDA125
1 1/2"	BVDA150
2"	BVDA200
2 1/2"	BVDA250
3"	BVDA300
4"	BVDA400



**Dual Approved Lockable**

SIZE	PART#
1/2"	BVDA050LO
3/4"	BVDA075LO
1"	BVDA100LO
1 1/4"	BVDA125LO
1 1/2"	BVDA150LO
2"	BVDA200LO



**Dual Approved Lilac Handle [Recycled Water]**

SIZE	PART#
1/2"	BVLDA050LO
3/4"	BVLDA075LO
1"	BVLDA100LO
1 1/4"	BVLDA125LO
1 1/2"	BVLDA150LO
2"	BVLDA200LO



**Dual Approved Male x Female**

SIZE	PART#
1/4"	BVDAMF025
3/8"	BVDAMF038
1/2"	BVDAMF050
3/4"	BVDAMF075
1"	BVDAMF100
1 1/4"	BVDAMF125
1 1/2"	BVDAMF150
2"	BVDAMF200
2 1/2"	BVDAMF250
3"	BVDAMF300
4"	BVDAMF400

# DUAL APPROVED & AGA® APPROVED BRASS BALL VALVES

## DUAL APPROVED WATERMARK® & AGA®



**Dual Approved Female x Female Butterfly Handle**



SIZE	PART#
1/2"	BVDAT050
3/4"	BVDAT075
1"	BVDAT100

**Dual Approved Male x Female Butterfly Handle**



SIZE	PART#
1/2"	BVDATMF050
3/4"	BVDATMF075
1"	BVDATMF100



**Dual Approved Female x Female Underground**



SIZE	PART#
1/2"	BVUGDAF050
3/4"	BVUGDAF075
1"	BVUGDAF100
1 1/4"	BVUGDAF125
1 1/2"	BVUGDAF150
2"	BVUGDAF200

## AGA® APPROVED



**AGA® Approved Female x Female**



SIZE	PART#
1/8"	BVAGA012
1/4"	BVAGA025
1/2"	BVAGA050
3/4"	BVAGA075
1"	BVAGA100
1 1/4"	BVAGA125
1 1/2"	BVAGA150
2"	BVAGA200
2 1/2"	BVAGA250
3"	BVAGA300
4"	BVAGA400

**AGA® Approved Female x Female Lockable**



SIZE	PART#
1"	BVAGA100LO
1 1/4"	BVAGA125LO



**AGA® Approved Male x Female**



SIZE	PART#
1/4"	BVAGAMF025
1/2"	BVAGAMF050
3/4"	BVAGAMF075

**AGA® Approved Male x Female Lockable**



SIZE	PART#
3/4"	BVAGAMF075LO
1"	BVAGAMF100LO
1 1/4"	BVAGAMF125LO



**1-pc Reduced Bore  
BSPP Thread**

SIZE	PART#
1/4"	SBV1P025
3/8"	SBV1P038
1/2"	SBV1P050
3/4"	SBV1P075
1"	SBV1P100
1-1/4"	SBV1P125
1-1/2"	SBV1P150
2"	SBV1P200



**2-pc Full Bore  
BSPP Thread**

SIZE	PART#
1/4"	SBV2P025
3/8"	SBV2P038
1/2"	SBV2P050
3/4"	SBV2P075
1"	SBV2P100
1-1/4"	SBV2P125
1-1/2"	SBV2P150
2"	SBV2P200
2-1/2"	SBV2P250
3"	SBV2P300
4"	SBV2P400

**STAINLESS STEEL BALL VALVE  
PRODUCT FEATURES:**

- For chemical and industrial applications.
- Blow-out proof stem design.
- 100% tested air under water.
- 1000psi WOG.
- Temperature: -28°C to 230°C
- Lockable



**3-pc Reduced Bore  
L-Port BSPP Thread**

SIZE	PART#
1/2"	SBVL050
3/4"	SBVL075
1"	SBVL100
1-1/4"	SBVL125
1-1/2"	SBVL150
2"	SBVL200
2-1/2"	SBVL250
3"	SBVL300



**3-pc Reduced Bore  
T-Port BSPP Thread**

SIZE	PART#
1/2"	SBVT050
3/4"	SBVT075
1"	SBVT100
1-1/4"	SBVT125
1-1/2"	SBVT150
2"	SBVT200
2-1/2"	SBVT250
3"	SBVT300



**3-pc Full Bore  
(Screwed Ends)  
BSPP Thread**

SIZE	PART#
1/4"	SBV3P025
3/8"	SBV3P038
1/2"	SBV3P050
3/4"	SBV3P075
1"	SBV3P100
1-1/4"	SBV3P125
1-1/2"	SBV3P150
2"	SBV3P200
2-1/2"	SBV3P250
3"	SBV3P300
4"	SBV3P400



**3-pc With ISO Mount  
BSPP Thread**

SIZE	PART#
1/2"	SBV3PMP050
3/4"	SBV3PMP075
1"	SBV3PMP100
1-1/4"	SBV3PMP125
1-1/2"	SBV3PMP150
2"	SBV3PMP200
2-1/2"	SBV3PMP250
3"	SBV3PMP300
4"	SBV3PMP400

# POLYPROPYLENE & DRY DISCONNECT VALVES

## “Stubby Valve”™ PATENTED

**Features:**

- All Teflon seals
- Unique patented compact design
- Stainless steel bolts
- Lightweight
- Glass filled polypropylene
- Maximum operating pressure 100PSI @ 70°F, 75 PSI @ 150°F.



### 2” Standard Port Cam & Groove Ball Valves Reduced Port

PART#	DESCRIPTION
VSF204B	2” Male Adaptor x 2” Femal BSP Thread
VSFM204B	2” Male Adaptor x 2” Male BSP Thread

## IBC 60mm TANK VALVE

**Features:**

- EDPM gasket
- Polypropylene body
- Aluminium ring

### IBC 60mm Tank Valve

SIZE	PART#
2”	IBCTV2PP



## DRY DISCONNECT COUPLINGS WITH BALL VALVE SHUT OFF

**Features:**

- Supplied as a complete set comprising of:  
2” adaptor + special coupler with ball valve shut off
- Provides dry disconnect action when placed in the closed position.
- Acts as an actuator mechanism for ‘Kamvalok’ style adaptors.
- Quick disconnect cam & groove style.
- Fully interchangeable with ‘Kamvalok’ style units.



### Aluminum Cam Coupling Dry Disconnect

SIZE	PART#
2”	D2000DT



**Wafer Style Butterfly Valve  
(Cast Iron)**

SIZE	NBR SEAT PART#	EPDM SEAT PART#	VITON SEAT PART#
2"	BFVW-2	BFWE-2	BFVWV-2
2 1/2"	BFVW-2.5	BFWE-2.5	BFVWV-2.5
3"	BFVW-3	BFWE-3	BFVWV-3
4"	BFVW-4	BFWE-4	BFVWV-4
5"	BFVW-5	BFWE-5	-
6"	BFVW-6	BFWE-6	BFVWV-6
8"	BFVW-8	BFWE-8	BFVWV-8
10"	BFVW-10	BFWE-10	-
12"	BFVW-12	BFWE-12	-
14"	BFVW-14	BFWE-14	-
16"	BFVW-16	BFWE-16	-
18"	BFVW-18	BFWE-18	-
20"	BFVW-20	BFWE-20	-
24"	BFVW-24	BFWE-24	-

**Wafer Style Butterfly Valve  
(Stainless Steel)**

SIZE	PTFE SEAT PART#
2"	BFVWT-2
2 1/2"	BFVWT-2.5
3"	BFVWT-3
4"	BFVWT-4
5"	BFVWT-5
6"	BFVWT-6



**Butterfly Valve  
Gear Operator**

SIZE	PART#
To suit 2"-3"	BFVGO-2-3
To suit 4"	BFVGO-4
To suit 5"-6"	BFVGO-5-6
To suit 8"	BFVGO-8
To suit 10"	BFVGO-10
To suit 12"	BFVGO-12

**Lugged Style Butterfly Valve  
(Cast Iron)**

SIZE	NBR SEAT PART#	EPDM SEAT PART#	ANSI150 NBR SEAT PART#
2"	BFVL-2	BFVLE-2	BFVLA-2
2 1/2"	BFVL-2.5	BFVLE-2.5	BFVLA-2.5
3"	BFVL-3	BFVLE-3	BFVLA-3
4"	BFVL-4	BFVLE-4	BFVLA-4
5"	BFVL-5	BFVLE-5	BFVLA-5
6"	BFVL-6	BFVLE-6	BFVLA-6
8"	BFVL-8	BFVLE-8	BFVLA-8
10"	BFVL-10	BFVLE-10	BFVLA-10
12"	BFVL-12	BFVLE-12	BFVLA-12
14"	BFVL-14	BFVLE-14	-
16"	BFVL-16	BFVLE-16	-
18"	BFVL-18	BFVLE-18	-
20"	BFVL-20	BFVLE-20	-
24"	BFVL-24	BFVLE-24	-



# CHECK VALVES

## BRASS



**2 Piece Spring Check Valve**

SIZE	PART#
3/8"	BSPCV3P038
1/2"	BSPCV3P050
3/4"	BSPCV3P075
1"	BSPCV3P100
1 1/4"	BSPCV3P125
1 1/2"	BSPCV3P150
2"	BSPCV3P200
2 1/2"	BSPCV3P250
3"	BSPCV3P300
4"	BSPCV3P400



**Watermark® Spring Check Valve**

SIZE	PART#
1/2"	BSWCV050-W



**Swing Check Valve**

SIZE	PART#
1/2"	BSWCV050
3/4"	BSWCV075
1"	BSWCV100
1 1/4"	BSWCV125
1 1/2"	BSWCV150
2"	BSWCV200
2 1/2"	BSWCV250
3"	BSWCV300
4"	BSWCV400

## STAINLESS STEEL



**2 Piece Spring Check Valve**

SIZE	PART#
1/4"	SSPCV025
3/8"	SSPCV038
1/2"	SSPCV050
3/4"	SSPCV075
1"	SSPCV100
1 1/4"	SSPCV125
1 1/2"	SSPCV150
2"	SSPCV200



**3 Piece Spring Check Valve**

SIZE	PART#
1/4"	SSPCV3P025
3/8"	SSPCV3P038
1/2"	SSPCV3P050
3/4"	SSPCV3P075
1"	SSPCV3P100
1 1/4"	SSPCV3P125
1 1/2"	SSPCV3P150
2"	SSPCV3P200
2 1/2"	SSPCV3P250
3"	SSPCV3P300
4"	SSPCV3P400



**Swing Check Valve**

SIZE	PART#
3/8"	SSWCV038
1/2"	SSWCV050
3/4"	SSWCV075
1"	SSWCV100
1 1/4"	SSWCV125
1 1/2"	SSWCV150
2"	SSWCV200
2 1/2"	SSWCV250
3"	SSWCV300
4"	SSWCV400

# GATE VALVES, STRAINERS, GLOBE VALVES & MISCELLANEOUS BRASS VALVES

VALVES

## GATE VALVES



**Stainless Steel Gate Valve**

SIZE	PART#
1/2"	SGV050
3/4"	SGV075
1"	SGV100
1 1/4"	SGV125
1 1/2"	SGV150
2"	SGV200
2 1/2"	SGV250
3"	SGV300
4"	SGV400



**Brass Gate Valve**

SIZE	PART#
1/2"	GV050
3/4"	GV075
1"	GV100
1 1/4"	GV125
1 1/2"	GV150
2"	GV200
2 1/2"	GV250
3"	GV300
4"	GV400



**Watermark® Brass Gate Valve**

SIZE	PART#
1/2"	GVW050
3/4"	GVW075
1"	GVW100
1 1/4"	GVW125
1 1/2"	GVW150
2"	GVW200
2 1/2"	GVW250
3"	GVW300
4"	GVW400

## STRAINERS



**Stainless Steel Y-Strainer**

SIZE	PART#
1/2"	SYS050
3/4"	SYS075
1"	SYS100
1 1/4"	SYS125
1 1/2"	SYS150
2"	SYS200
2 1/2"	SYS250
3"	SYS300
4"	SYS400

## GLOBE VALVES



**Stainless Steel Globe Valve**

SIZE	PART#
1/2"	SGLBV050
3/4"	SGLBV075
1"	SGLBV100
1 1/4"	SGLBV125
1 1/2"	SGLBV150
2"	SGLBV200

## MISCELLANEOUS BRASS VALVES



**Brass Bib-Cock Tank Valve**

SIZE	PART#
1/2"	BVBC050
3/4"	BVBC075
1"	BVBC100



**Brass Nozzle Valve**

SIZE	PART#
1/2"	BVN050
3/4"	BVN075
1"	BVN100



**Brass Mine Tap (Bendigo)**

SIZE	PART#
1/2"	TH29

MILLENNIUM COUPLING COMPANY

“WE WORK UNDER PRESSURE!”

# 08

## FIRE PRODUCTS



Instantaneous Fire Couplings & Adaptors

86 - 88



Fire Hydrant Valves & Nozzles

89



Branchpipes

90



Branchpipes, Spindles & Breechings

91



## 2-1/2 INSTANTANEOUS FIRE COUPLINGS & ADAPTORS WORKING PRESSURE 15 BAR



**Aluminum Female  
x Hose Tail**

PART#	SIZE
1F	2.1/2 x 1.1/2
2F	2.1/2 x 1.3/4
3F	2.1/2 x 2
4F	2.1/2 x 2.1/2
5F	2.1/2 x 2.3/4
6F	2.1/2 x 3



**Aluminium Male  
x Hose Tail**

PART#	SIZE
1M	2.1/2 x 1.1/2
2M	2.1/2 x 1.3/4
3M	2.1/2 x 2
4M	2.1/2 x 2.1/2
5M	2.1/2 x 2.3/4
6M	2.1/2 x 3



**Gunmetal Female  
x Hose Tail**

PART#	SIZE
1FGM	2.1/2 x 1.1/2
2FGM	2.1/2 x 1.3/4
3FGM	2.1/2 x 2
4FGM	2.1/2 x 2.1/2
5FGM	2.1/2 x 2.3/4



**Gunmetal Male  
x Hose Tail**

PART#	SIZE
1MGM	2.1/2 x 1.1/2
2MGM	2.1/2 x 1.3/4
3MGM	2.1/2 x 2
4MGM	2.1/2 x 2.1/2
5MGM	2.1/2 x 2.3/4



**Aluminium Female  
x BSPP Male**

PART#	SIZE
1FXM	1
2FXM	1.1/2
13FXM	2
14FXM	2.1/2
15FXM	3



**Aluminium Female  
x BSPP Female**

PART#	SIZE
0.75FXF	3/4
1FXF	1
2FXF	1.1/2
13FXF	2
14FXF	2.1/2
15FXF	3



**Gunmetal Female  
x BSPP Male**

PART#	SIZE
2FXMGM	1.1/2
13FXMGM	2
14FXMGM	2.1/2
15FXMGM	3



**Gunmetal Female  
x BSPP Female**

PART#	SIZE
2FXFGM	1.1/2
13FXFGM	2
14FXFGM	2.1/2

# INSTANTANEOUS FIRE COUPLINGS & ADAPTORS

## 2-1/2 INSTANTANEOUS FIRE COUPLINGS & ADAPTORS WORKING PRESSURE 15 BAR



**Aluminium Male  
x BSPP Male**

PART#	SIZE
22MXM	3/4
23MXM	1
24MXM	1.1/2
25MXM	2
26MXM	2.1/2
27MXM	3



**Gunmetal Male  
x BSPP Male**

PART#	SIZE
24MXMGM	1.1/2
25MXMGM	2
26MXMGM	2.1/2



**Aluminium Male  
x BSPP Female**

PART#	SIZE
28MXF	3/4"
29MXF	1"
30MXF	1.1/2"
31MXF	2"
32MXF	2.1/2"
33MXF	3"



**Gunmetal Male  
x BSPP Female**

PART#	SIZE
30GM	1.1/2"
31GM	2"
32GM	2.1/2"



**Gunmetal Male  
x Male Adaptor**

PART#	SIZE
34GM	2.1/2"



**Gunmetal  
Blank Caps**

PART#	SIZE
36	2.1/2"



**Aluminium Male  
x Male Adaptor**

PART#	SIZE
34MAxMA	2.1/2"



**Gunmetal  
Blank Plugs**

PART#	SIZE
38GM	2.1/2"

## 2-1/2 INSTANTANEOUS FIRE COUPLINGS & ADAPTORS WORKING PRESSURE 15 BAR



**Aluminium  
Blank Caps**

PART#	SIZE
35	2.1/2"



**Industrial 'Works'  
Type Adaptor  
2 1/2 Instantaneous  
Male x Hose Spigott**

PART#	SIZE
39MWT	1/2" H/T
40MWT	3/4" H/T
41MWT	1" H/T



**Aluminium  
Blank Plugs**

PART#	SIZE
37	2.1/2"



**Spare Instantaneous  
Gasket**

PART#	SIZE
2.5INSTG	2.1/2"



**Aluminium BS336  
Round Thread Male**

PART#	SIZE
336MAL4	4"
336MAL55	51/2"



**Aluminium  
BS336 Round  
Thread Female**

PART#	SIZE
336FAL4	4"
336FAL55	51/2"



**STAINLESS STEEL BAND  
& BUCKLE  
- PAGES 62 -64**

# HYDRANT VALVES & NOZZLES

## FIRE HYDRANT VALVES (FLANGE x INSTANTANEOUS FEMALE) GUNMETAL



**Horizontal**

PART#	SIZE
100	2.1/2 T/D
101	65mm PN16
102	2.1/2 ASA150



**Right Angle**

PART#	SIZE
103	2.1/2 T/D
104	65mm PN16
105	2.1/2 ASA150



**Bib Hose**

PART#	SIZE
106	2.1/2 T/D
107	65mm PN16
108	2.1/2 ASA150



**Oblique**

PART#	SIZE
109	2.1/2 T/D
110	65mm PN16
111	2.1/2 ASA150

## FIRE HYDRANT NOZZLES



**Red Plastic Fire Reel Jet Spray Nozzle**

PART#	SIZE
218	3/4" H/T
219	1" H/T



**Red Plastic "Mushroom" Fire Reel Jet Spray Nozzle**

PART#	SIZE
220	3/4"
221	1"



**Chrome Plate Brass Lever Operated Jet Spray Nozzle**

PART#	SIZE
222	3/4"
223	1"



**Chome Plated Brass Twist Operated Jet Spray Nozzle**

PART#	SIZE
224	3/4"
225	1"



**Aluminium  
1 Piece Combined  
Branchpipe and  
Nozzle**

PART#	SIZE
200	2.1/2 INST x 5/8



**Aluminium  
Branchpipe C/W  
Screw on Nozzle**

PART#	SIZE
201	2.1/2 x 1/2
202	2.1/2 x 5/8
203	2.1/2 x 3/4



**One Piece  
Plastic Branchpipe  
Plain Jet**

PART#	SIZE
211	INSTM x 1/2"
212	INSTM x 5/8"
213	INSTM x 3/4"
214	INSTM x 1"



**H.S "UniFire"  
Type Marine  
Approved Twist  
Operated Jet Spray**

PART#	SIZE
208	BSPM x 12mm
209	BSPM x 16mm
210	BSPM x 20mm



**Aluminium Twist  
Operated Jet Spray  
Diffuser Nozzle**

PART#	SIZE
204	2.1/2 INST x 5/8



**Gunmetal Twist  
Operated Jet Spray  
Diffuser Nozzle**

PART#	SIZE
205	2.1/2 INST x 5/8



**Aluminium Lever  
Operated Jet Spray  
DIN Pattern**

PART#	SIZE
206	2.1/2 x 9mm



**Plastic  
and Aluminium  
Lever Operated Jet  
Spray DIN Pattern**

PART#	SIZE
207	2.1/2 x 9mm

# NOZZLES, SPINDLES & BREECHINGS



**Multifire 105 Twist Operated Jet Spray Hose Reel Nozzle**

PART#	SIZE
215	1" BSPFEM



**Hose Reel Nozzle Twist Operated Euro**

PART#	SIZE
216	3/4" HK
217	1" HK



**False Spindles for Underground Hydrant**

PART#	SIZE
FS19	19mm
FS21	21mm
FS28	28mm
FS32	32mm
FS38	38mm



**Underground Hydrant**

PART#	SIZE
UH	80mm NP16 x 2.5 INST MALE



**Standard Dividing Breeching**

PART#	SIZE
SDB	2.5"



**Dividing Breeching with Ball Valves**

PART#	SIZE
HR3	75mm Hose
HR4	100mm Hose
HR5	135mm Hose

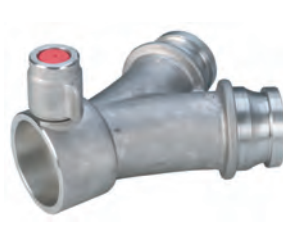

**Collecting Breechings**

PART#	SIZE
CB1	2.5"

# OTHER ASSOCIATED PRODUCT RANGES

MCC can provide a single source supply choice for all fire protection related products

OTHER ASSOCIATED PRODUCT RANGES



MILLENNIUM COUPLING COMPANY

“WE WORK UNDER PRESSURE!”

# 09

## PNEUMATICS

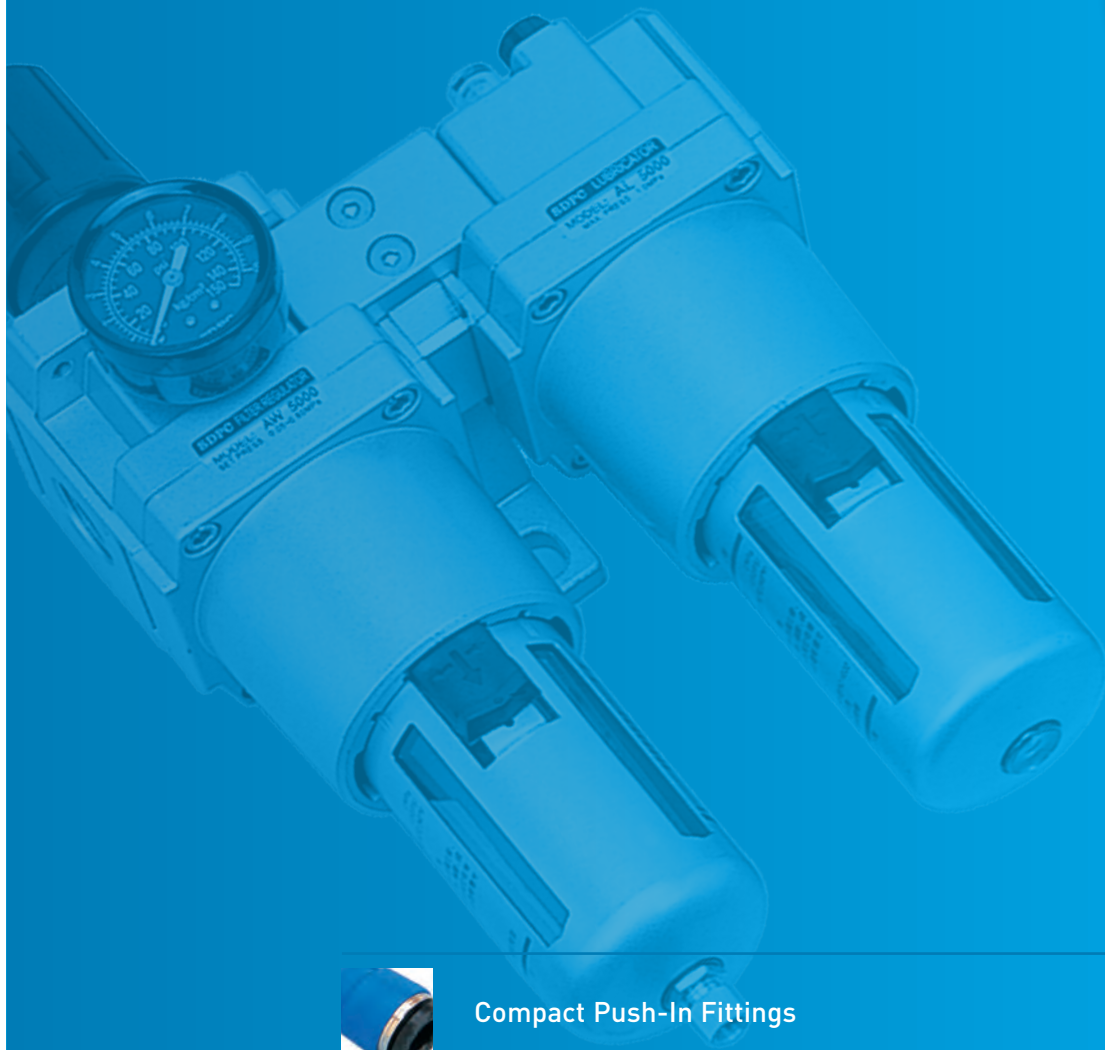

Compact Push-In Fittings

94 - 97



Air Source Treatment Units

98 - 99



Tubing

100



Whipchecks & Blow Guns

101



Swivel Adaptors

102



# COMPACT PUSH-IN FITTINGS

PNEUMATIC

## TECHNICAL INFORMATION

**Maximum Pressure:** 10bar  
**Maximum Temperature:** 60°C  
**Metal Studs:** Nickel Plated brass

**Body:** Polybutylene  
**Security Ring:** Stainless Steel  
**'O' Ring Seal:** Nitrile



**Male Stud Coupling BSPT**

PART#	O.D.	THREAD
JPC4-M5	4	M5
JPC4-01	4	1/8
JPC4-02	4	1/4
JPC6-M5	6	M5
JPC6-01	6	1/8
JPC6-02	6	1/4
JPC8-01	8	1/8
JPC8-02	8	1/4
JPC8-03	8	3/8
JPC10-02	10	1/4
JPC10-03	10	3/8
JPC10-04	10	1/2
JPC12-02	12	1/4
JPC12-03	12	3/8
JPC12-04	12	1/2

**Male Stud Coupling BSPP**

PART#	O.D.	THREAD
JPC4-01-PT	4	1/8
JPC4-02-PT	4	1/4
JPC6-01-PT	6	1/8
JPC6-02-PT	6	1/4
JPC8-01-PT	8	1/8
JPC8-02-PT	8	1/4
JPC8-03-PT	8	3/8
JPC10-02-PT	10	1/4
JPC10-03-PT	10	3/8
JPC10-04-PT	10	1/2
JPC12-02-PT	12	1/4
JPC12-03-PT	12	3/8
JPC12-04-PT	12	1/2

**Female Stud Coupling BSPP**

PART#	O.D.	THREAD
JPCF4-M5	4	M5
JPCF4-01	4	1/8
JPCF4-02	4	1/4
JPCF6-01	6	1/8
JPCF6-02	6	1/4
JPCF8-01	8	1/8
JPCF8-02	8	1/4
JPCF8-03	8	3/8
JPCF10-02	10	1/4
JPCF10-03	10	3/8
JPCF12-02	12	1/4
JPCF12-03	12	3/8
JPCF12-04	12	1/2

**Long Elbow Male Stud BSPT**

PART#	O.D.	THREAD
JPLL4-M5	4	M5
JPLL4-01	4	1/8
JPLL4-02	4	1/4
JPLL6-01	6	1/8
JPLL6-02	6	1/4
JPLL6-03	6	3/8
JPLL8-01	8	1/8
JPLL8-02	8	1/4
JPLL8-03	8	3/8
JPLL10-02	10	1/4
JPLL10-03	10	3/8
JPLL10-04	10	1/2
JPLL12-02	12	1/4
JPLL12-03	12	3/8
JPLL12-04	12	1/2

**PRE-FORMED NYLON AIRLINE COILS - PAGE 100**

**NYLON TUBING - PAGE 100**

# COMPACT PUSH-IN FITTINGS



**Elbow Male Stud BSPT**

PART#	O.D. THREAD	
JPL4-M5	4	M5
JPL4-01	4	1/8
JPL4-02	4	1/4
JPL6-M5	6	M5
JPL6-01	6	1/8
JPL6-02	6	1/4
JPL6-03	6	3/8
JPL8-01	8	1/8
JPL8-02	8	1/4
JPL8-03	8	3/8
JPL8-04	8	1/2
JPL10-02	10	1/4
JPL10-03	10	3/8
JPL10-04	10	1/2
JPL12-02	12	1/4
JPL12-03	12	3/8
JPL12-04	12	1/2



**Compact Elbow Male Stud**

PART#	O.D. THREAD	
JPH4-M5	4	M5
JPH4-01	4	1/8
JPH4-02	4	1/4
JPH6-01	6	1/8
JPH6-02	6	1/4
JPH8-01	8	1/8
JPH8-02	8	1/4
JPH8-03	8	3/8
JPH10-02	10	1/4
JPH10-03	10	3/8
JPH12-02	12	1/4
JPH12-03	12	3/8
JPH12-04	12	1/2



**Female Stud Elbow BSPP**

PART#	O.D. THREAD	
JPLF4-01	4	1/8
JPLF4-02	4	1/4
JPLF6-01	6	1/8
JPLF6-02	6	1/4
JPLF6-03	6	3/8
JPLF8-01	8	1/8
JPLF8-02	8	1/4
JPLF8-03	8	3/8
JPLF10-02	10	1/4
JPLF10-03	10	3/8
JPLF12-02	12	1/4
JPLF12-03	12	3/8
JPLF12-04	12	1/2



**Tee Male Stud Branch BSPT**

PART#	O.D. THREAD	
JPB4-M5	4	M5
JPB4-01	4	1/8
JPB4-02	4	1/4
JPB6-01	6	1/8
JPB6-02	6	1/4
JPB8-01	8	1/8
JPB8-02	8	1/4
JPB8-03	8	3/8
JPB10-02	10	1/4
JPB10-03	10	3/8
JPB12-02	12	1/4
JPB12-03	12	3/8
JPB12-04	12	1/2



**Tee Male Stud Run BSPT**

PART#	O.D. THREAD	
JPD4-M5	4	M5
JPD4-01	4	1/8
JPD4-02	4	1/4
JPD6-01	6	1/8
JPD6-02	6	1/4
JPD8-01	8	1/8
JPD8-02	8	1/4
JPD8-03	8	3/8
JPD10-02	10	1/4
JPD10-03	10	3/8
JPD12-02	12	1/4
JPD12-03	12	3/8
JPD12-04	12	1/2



**Female Bulkhead Coupling BSPP**

PART#	O.D. THREAD	
JPMF4-01	4	1/8
JPMF6-01	6	1/8
JPMF6-02	6	1/4
JPMF8-01	8	1/8
JPMF8-02	8	1/4
JPMF8-03	8	3/8
JPMF10-02	10	1/4
JPMF10-03	10	3/8
JPMF12-03	12	3/8
JPMF12-04	12	1/2



**Equal Ended Coupling**

PART#	O.D.
JPU4	4
JPU6	6
JPU8	8
JPU10	10
JPU12	12



Bulkhead Elbow

PART#	O.D.
JPML4	4
JPML6	6
JPML8	8
JPML10	10
JPML12	12



Bulkhead

PART#	O.D.
JPM4	4
JPM6	6
JPM8	8
JPM10	10
JPM12	12



Equal Elbow

PART#	O.D.
JPV4	4
JPV6	6
JPV8	8
JPV10	10
JPV12	12



Reducing Couplings

PART#	O.D.
JPG6-4	6
JPG8-4	8
JPG8-6	8
JPG10-8	10
JPG12-10	12



Equal Tee

PART#	O.D.
JPE4	4
JPE6	6
JPE8	8
JPE10	10
JPE12	12



'Y' Piece Male BSPT

PART#	O.D.	THREAD
JPX4-M5	4	M5
JPX4-01	4	1/8
JPX4-02	4	1/4
JPX6-01	6	1/8
JPX6-02	6	1/4
JPX6-03	6	3/8
JPX8-01	8	1/8
JPX8-02	8	1/4
JPX8-03	8	3/8
JPX10-02	10	1/4
JPX10-03	10	3/8
JPX10-04	10	1/2
JPX12-02	12	1/4
JPX12-03	12	3/8
JPX12-04	12	1/2

Equal/Unequal  
'Y' Piece

PART#	O.D.
JPY4	4
JPY6	6
JPY8	8
JPY10	10
JPY12	12
JPY6-4	6-4
JPY8-6	8-6



Reducing Stem

PART#	O.D.
JPGJ6-4	4
JPGJ8-4	4
JPGJ8-6	6
JPGJ10-6	6
JPGJ10-8	8
JPGJ12-6	6
JPGJ12-8	8
JPGJ12-10	10

# COMPACT PUSH-IN FITTINGS



**Stem Elbow**

PART#	O.D.	THREAD
JPLJ4	4	4
JPLJ6	6	6
JPLJ8	8	8
JPLJ10	10	10
JPLJ12	12	12



**Straight Connector**

PART#	O.D.
JP1J4	4
JP1J6	6
JP1J8	8
JP1J10	10
JP1J12	12



**Blanking Plug**

PART#	O.D.
JPP4	4
JPP6	6
JPP8	8
JPP10	10
JPP12	12

## ECONOMY RANGE MOUNT REGULATOR



**Banjo Speed Controls**

Meter Out-Standard Range		
PART#	O.D.	THREAD
JMJSC4-M5A	4	M5
JMJSC4-01A	4	1/8
JMJSC6-M5A	6	M5
JMJSC6-01A	6	1/8
JMJSC6-02A	6	1/4
JMJSC6-03A	6	3/8
JMJSC8-01A	8	1/8
JMJSC8-02A	8	1/4
JMJSC8-03A	8	3/8
JMJSC10-02A10	10	1/4
JMJSC10-03A10	10	3/8
JMJSC10-04A10	10	1/2
JMJSC12-03A12	12	3/8
JMJSC12-04A12	12	1/2



**In Line Speed Controllers**

Standard Range	
PART#	O.D.
JMJSU4	4
JMJSU6	6
JMJSU8	8
JMJSU10	10
JMJSU12	12



**Banjo Speed Controls**

Meter Out-Budget Range		
PART#	O.D.	THREAD
JSC4-M5A	4	M5
JSC4-01A	4	1/8
JSC6-M5A	6	M5
JSC6-01A	6	1/8
JSC6-02A	6	1/4
JSC6-03A	6	3/8
JSC8-01A	8	1/8
JSC8-02A	8	1/4
JSC8-03A	8	3/8
JSC10-02A	10	1/4
JSC10-03A	10	3/8
JSC10-04A	10	1/2
JSC12-03A	12	3/8
JSC12-04A	12	1/2



**In Line Speed Controllers**

Budget Range	
PART#	O.D.
JVA4	4
JVA6	6
JVA8	8
JVA10	10



### AC Series - Filter+Regulator+Atomized Lubricator

Type	AC300A	AC400A	AC500A
Port Size (G)	1/4"	3/8" · 1/2"	3/4" · 1"
Gauge thread (G)	1/8"	1/4"	1/4"
Fluid		Air	
Pressure range (Mpa)		0.05-0.99	
Max. Flow rate (NI/min)	2000	4000	5000
Ambient temperature		-10~60°C	
Filter precision		Standard: 5 µm	
Oil recommended		Turbine Oil (ISO VG32)	
Cup material		Polycarbonate	
Structure		Overflow type	
Optional Guard cup	•	•	•
Optional Bracket	30L	40L	50L



### Compact AC Series - Filter+Regulator+Atomized Lubricator

Type	AC301A	AC401A	AC501A
Port Size (G)	1/4"	3/8" · 1/2"	3/4" · 1"
Gauge thread (G)	1/8"	1/4"	1/4"
Fluid		Air	
Pressure range (Mpa)		0.05-0.99	
Max. Flow rate (NI/min)	1700	3000	5000
Ambient temperature		-10~60°C	
Filter precision		Standard: 5 µm	
Oil recommended		Turbine Oil (ISO VG32)	
Cup material		Polycarbonate	
Structure		Overflow type	
Optional Guard cup	•	•	•
Optional Bracket	30T	40T	50T

# AIR SOURCE TREATMENT UNITS



## AW Series - Filter Regulator

Type	AW300A	AW400A	AW500A
Port Size (G)	1/4"	3/8" · 1/2"	3/4" · 1"
Gauge thread (G)	1/8"	1/4"	1/4"
Fluid		Air	
Pressure range (Mpa)		0.05~0.99	
Ambient temperature		-10~60°C	
Filter precision		Standard: 5 µm	
Cup material		Polycarbonate	
Capacity (cm <sup>2</sup> )	30	45	45
Guard cup	•	•	•



## AF Series - Filter

Type	AF300A	AF400A	AF500A
Port Size (G)	1/4"	3/8" · 1/2"	3/4" · 1"
Gauge thread (G)	1/8"	1/4"	1/4"
Fluid		Air	
Pressure range (Mpa)		0.05~0.99	
Ambient temperature		-10~60°C	
Filter precision		Standard: 5 µm	
Cup material		Polycarbonate	
Capacity (cm <sup>2</sup> )	20	45	45
Guard cup	•	•	•

## AR Series - Regulator

Type	AR300A	AR400A	AR500A
Port Size (G)	1/4"	3/8" · 1/2"	3/4" · 1"
Gauge thread (G)	1/8"	1/4"	1/4"
Fluid		Air	
Pressure range (Mpa)		0.05~0.99	
Ambient temperature		-10~60°C	



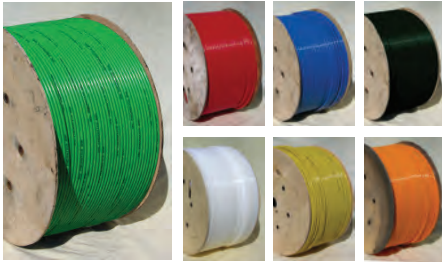

### Nylon Tubing - Metric Light Duty

PART#	METRIC SIZE		WEIGHT PER COIL (KG)
	O.D.	I.D.	
NLF0404	4	3	0.21
NLF0602	6	4.5	0.41
NLF0804	8	6	0.72
NLF1006	10	7.5	1.13
NLF1025	10	8	0.88
NLF1202	12	9.5	1.37
NLF1201	12	10	1.07
NLF1602	16	13	2.23

### Nylon Tubing - Metric Medium Duty

PART#	METRIC SIZE		WEIGHT PER COIL (KG)
	O.D.	I.D.	
NMF0405	4	2.5	0.25
NMF0506	5	3.3	0.36
NMF0607	6	4	0.52
NMF0803	8	5.5	0.87
NMF1003	10	7	1.31
NMF1229	12	9	1.53
NMF1605	16	12	2.88
NMF1804	18	14	3.29
NMF2202	22	17	5
NMF2801	28	22	7.69

### SPECIAL FEATURES

- Manufactured from heat and light stabilised Type 12 Nylon to precise tolerances.
- High resistance to moisture absorption
- Resistance to a wide range of chemicals (see Chemical Resistance Table)
- Suitable for use in air brake, fuel and lube applications, notwithstanding instrumentation and secondary air systems

### COLOUR CODES

Lubrication Lines: Black

Fuel & Air Lines: Natural

Emergency Trailer Lines: Red

Service Trailer Lines: Yellow

Auxiliary Trailer Lines: Blue



### Preformed Nylon Industrial Airline Coils (UK and European Sizes)

PRODUCT REF.	WORKING LENGTH	COLOUR	FITTINGS	SIZE	
				O.D.	I.D.
EC08/WF025	2.5m	Red	1/4" BSPT	8	6
EC08/WF025	2.5m	Blue	1/4" BSPT	8	6
EC08/WF/05	5m	Red	1/4" BSPT	8	6
EC08/WF/05	5m	Blue	1/4" BSPT	8	6
EC08/WF/10	10m	Red	1/4" BSPT	8	6
EC08/WF/10	10m	Blue	1/4" BSPT	8	6
EC08/WF/15	15m	Red	1/4" BSPT	8	6
EC08/WF/15	15m	Blue	1/4" BSPT	8	6
EC10/WF/05	5m	Red	1/4" BSPT	10	8
EC10/WF/05	5m	Blue	1/4" BSPT	10	8
EC10/WF/10	10m	Red	1/4" BSPT	10	8
EC10/WF/10	10m	Blue	1/4" BSPT	10	8
EC12/WF025	2.5m	Red	3/8" BSPT	12	9
EC12/WF025	2.5m	Blue	3/8" BSPT	12	9
EC12/WF/05	5m	Red	3/8" BSPT	12	9
EC12/WF/05	5m	Blue	3/8" BSPT	12	9
EC12/WF/10	10m	Red	3/8" BSPT	12	9
EC12/WF/10	10m	Blue	3/8" BSPT	12	9

All coils are contained within sealed polyethylene tube with identification label.

### TECHNICAL INFORMATION

Maximum Pressure: 15bar

Temperature Range: -40°C to +80°C

# WHIPCHECKS & BLOW GUNS

## WHIPCHECK SAFETY RESTRAINT

### For Hose-to-Hose Service

PART #	CABLE	HOSE ID	LENGTH
WCB1	3.5mm	15mm (1/2") - 32mm (1 1/4')	515mm
WCA2	6mm	40mm (1 1/2") - 80mm (3")	962mm

### For Hose-to-Tool Service

PART #	CABLE	HOSE ID	LENGTH
WCSR1	3mm	15mm (1/2") - 32mm (1 1/4')	515mm
WCSR2	5mm	40mm (1 1/2") - 80mm (3")	710mm

Steel cable, Aluminium ferrules.

Strong steel cables with spring loaded loops which are used on air, steam hoses, etc for the safe holding of assemblies should they become accidentally separated. Prevents injury to operators and damage to plant and machinery. Manufactured from steel and aluminium components for standard applications.



## Brass Ferrules for Mining Applications

PART #	CABLE	HOSE ID	LENGTH
WC2390	3.5mm	3/8" - 1 1/4'	510mm
WC2391	6 mm	1 1/4" - 2"	810mm
WC2392	8 mm	2 1/2" - 4"	1200mm

Steel cable, Brass ferrules.

Designed specifically for securing hose to hose connections in Underground Mining. Heavy duty Non-sparking brass ferrule makes these safety cables suitable for use in underground coal mining applications.



## AIR HOSE BLOW GUNS



### Rubber Tipped Blow Gun

PART#	THREAD
AKB101	1/4 BSPP



### Pistol Grip Blow Gun

PART#	THREAD
AKB102	1/4 BSPP



### Extension Tube for Blow Guns

PART#	THREAD
AKB103	N/A

## BALL TYPE SWIVEL ADAPTORS - 8-B SERIES

### FEATURES

- Market leading ball type swivel adaptor.
- 2" long hose barb for safer and more secure installation.
- Locking O-rings and built in lever lock ring minimise hand fatigue.
- 360° Swivel adaptor prevent hose kinking.
- Ergonomically designed to rotate with hand movements when using hose.



### Ball Type Swivel Adaptors

PART #	SIZE	MATERIAL
SHABT050050	1/2" NPT X 1/2" HOSE BARB	BRASS & 300 SERIES STAINLESS STEEL
SHABT050075	3/4" NPT X 1/2" HOSE BARB	BRASS & 300 SERIES STAINLESS STEEL

## STANDARD SWIVEL ADAPTORS - 8-B SERIES

### FEATURES

- 2" long hose barb for safer and more secure installation.
- Locking O-rings and built in lever lock ring minimise hand fatigue.
- 360° Swivel adaptor prevent hose kinking.



### Ball Type Swivel Adaptors

PART #	SIZE	MATERIAL
SHA050050	1/2" NPT X 1/2" HOSE BARB	BRASS & 300 SERIES STAINLESS STEEL
SHA050075	3/4" NPT X 1/2" HOSE BARB	BRASS & 300 SERIES STAINLESS STEEL

MILLENNIUM COUPLING COMPANY

“WE WORK UNDER PRESSURE!”

# 10

## 150LB THREADED PARTS



Malleable Iron Threaded Fittings

104 - 109



Stainless Steel 316 - 150Lb BSP Screwed Fittings

110 - 112



# MALLEABLE IRON THREADED FITTINGS

150LB THREADED PARTS



**Hexagon Nipple  
Black BSPT**

PART#	SIZE
14623317	1/4
14623328	3/8
14623339	1/2
14623350	3/4
14623361	1
14623372	1 1/4
14623383	1 1/2
14623394	2



**Hexagon Nipple  
Galvanised BSPT**

PART#	SIZE
14671801	1/4
14671812	3/8
14671823	1/2
14671834	3/4
14671845	1
14671856	1 1/4
14671867	1 1/2
14671878	2



**Hexagon Red  
Nipple Black BSPT**

PART#	SIZE
14623701	(1/4x1/8")
14623723	(3/8x1/4")
14623745	(1/2x1/4")
14623756	(1/2x3/8")
14623778	(3/4x3/8")
14623789	(3/4x1/2")
14623830	(1x1/2")
14623841	(1x3/4")
14623874	(1 1/4x1")
14623904	(1 1/2x1")
14623915	(1 1/2x1 1/4")
14623970	(2x1 1/2")



**Hexagon Red Nipple  
Galvanised BSPT**

PART#	SIZE
14672002	(1/4x1/8")
14672013	(3/8x1/4")
14672024	(1/2x1/4")
14672035	(1/2x3/8")
14672046	(3/4x3/8")
14672057	(3/4x1/2")
14672068	(1x1/2")
14672079	(1x3/4")
14672120	(1 1/4x1")
14672131	(1 1/2x1")
14672142	(1 1/2x1 1/4")
14672175	(2x1 1/2")



**Female Socket  
Black BSPP**

PART#	SIZE
14636395	1/8
14636403	1/4
14636414	3/8
14636425	1/2
14636436	3/4
14636447	1
14636458	1 1/4
14636469	1 1/2
14636480	2



**Female Socket  
Galvanised BSPP**

PART#	SIZE
14675255	1/8
14675266	1/4
14675277	3/8
14675288	1/2
14675299	3/4
14675307	1
14675318	1 1/4
14675329	1 1/2
14675340	2



**Equal Cross  
Black BSPP**

PART#	SIZE
14633323	1/2
14633334	3/4
14633345	1
14633356	1 1/4
14633367	1 1/2
14633378	2



**Equal Cross  
Galvanised BSPP**

PART#	SIZE
14675126	1/2
14675137	3/4
14675148	1
14675159	1 1/4
14675170	1 1/2
14675181	2



# MALLEABLE IRON THREADED FITTINGS



## Male/Female Hexagon Bush Black

PART#	SIZE M x F	PART#	SIZE M x F
14620407	(1/4x1/8")	14620621	(11/4x1")
14620418	(3/8x1/8")	14620654	(11/2x1/2")
14620429	(3/8x1/4")	14620665	(11/2x3/4")
14620440	(1/2x1/8")	14620676	(11/2x1")
14620451	(1/2x1/4")	14620687	(11/2x1 1/4")
14620462	(1/2x3/8")	14620717	(2x1 1/2")
14620473	(3/4x1/8")	14620728	(2x3/4")
14620484	(3/4x1/4")	14620739	(2x1")
14620495	(3/4x3/8")	14620750	(2x1 1/4")
14620503	(3/4x1/2")	14620761	(2x1 1/2")
14620525	(1x1/4")	14620813	(2 1/2x1 1/2")
14620536	(1x3/8")	14620824	(2 1/2x2")
14620547	(1x1/2")	14620890	(3x2")
14620558	(1x3/4")	14620909	(3x2 1/2")
14620591	(1 1/4x1 1/2")	14621025	(4x2")
14620610	(1 1/4x3/4")	14621047	(4x3")

## Male/Female Hexagon Bush Galvanised

PART#	SIZE M x F	PART#	SIZE M x F
14671011	(1/4x1/8")	14671214	(11/4x1")
14671022	(3/8x1/8")	14671247	(11/2x1 1/2")
14671033	(3/8x1/4")	14671258	(11/2x3/4")
14671044	(1/2x1/8")	14671269	(11/2x1")
14671055	(1/2x1/4")	14671280	(11/2x1 1/4")
14671066	(1/2x3/8")	14671321	(2x1 1/2")
14671077	(3/4x1/8")	14671332	(2x3/4")
14671088	(3/4x1/4")	14671343	(2x1")
14671099	(3/4x3/8")	14671354	(2x1 1/4")
14671107	(3/4x1/2")	14671365	(2x1 1/2")
14671129	(1x1/4")	14671417	(2 1/2x1 1/2")
14671140	(1x3/8")	14671428	(2 1/2x2")
14671151	(1x1/2")	14671494	(3x2")
14671162	(1x3/4")	14671502	(3x2 1/2")
14671195	(1 1/4x1 1/2")	14671557	(4x2")
14671203	(1 1/4x3/4")	14671559	(4x3")



## Hexagon Back Nut Black

PART#	SIZE
14626216	1/4
14626227	3/8
14626238	1/2
14626249	3/4
14626260	1
14626271	1 1/4
14626282	1 1/2
14626293	2

## Hexagon Back Nut Galvanised

PART#	SIZE
14672803	1/4
14672814	3/8
14672825	1/2
14672836	3/4
14672847	1
14672858	1 1/4
14672869	1 1/2
14672880	2

## Blank Cap Black BSPP

PART#	SIZE
14640013	1/4
14640024	3/8
14640035	1/2
14640046	3/4
14640057	1
14646268	1 1/4
14640079	1 1/2
14640090	2

## Blank Cap Galvanised BSPP

PART#	SIZE
14676405	1/4
14676416	3/8
14676427	1/2
14676438	3/4
14676449	1
14676460	1 1/4
14676471	1 1/2
14676482	2



**Female Reducing Socket Black BSPP**

PART#	SIZE	PART#	SIZE
14637630	{3/8x1/4"}	14637770	{11/4x3/4"}
14637652	{1/2x1/4"}	14637781	{11/4x1"}
14637663	{1/2x3/8"}	14637800	{11/2x1/2"}
14637674	{3/4x1/4"}	14637811	{11/2x3/4"}
14637685	{3/4x3/8"}	14637822	{11/2x1"}
14637696	{3/4x1/2"}	14637833	{11/2x11/4"}
14637704	{1x1/4"}	14637866	{2x1/2"}
14637715	{1x3/8"}	14637877	{2x3/4"}
14637726	{1x1/2"}	14637888	{2x1"}
14637737	{1x3/4"}	14637899	{2x11/4"}
14637759	{11/4x1/2"}	14637907	{2x11/2"}



**Female Reducing Socket Galvanised BSPP**

PART#	SIZE	PART#	SIZE
14675606	{3/8x1/4"}	14675724	{11/4x3/4"}
14675617	{1/2x1/4"}	14675735	{11/4x1"}
14675628	{1/2x3/8"}	14675746	{11/2x1/2"}
14675639	{3/4x1/4"}	14675757	{11/2x3/4"}
14675650	{3/4x3/8"}	14675768	{11/2x1"}
14675661	{3/4x1/2"}	14675779	{11/2x11/4"}
14675672	{1x1/4"}	14675790	{2x1/2"}
14675683	{1x3/8"}	14675809	{2x3/4"}
14675694	{1x1/2"}	14675820	{2x1"}
14675702	{1x3/4"}	14675831	{2x11/4"}
14675713	{11/4x1/2"}	14675842	{2x11/2"}



**Equal Female Elbow Black BSPP**

PART#	SIZE
14626600	1/8
14626611	1/4
14626622	3/8
14626633	1/2
14626644	3/4
14626655	1
14626666	11/4
14626677	11/2
14626688	2
14626699	2/12
14626707	3
14626729	4



**Equal Female Elbow Galv. BSPP**

PART#	SIZE
14672954	1/8
14672965	1/4
14672976	3/8
14672987	1/2
14672998	3/4
14673004	1
14673015	11/4
14673026	11/2
14673037	2
14673048	2/12
14673059	3
14673070	4



**Equal Male & Female Elbow Black**

PART#	SIZE
14627923	3/8
14627934	1/2
14627945	3/4
14627956	1
14627967	11/4
14627978	11/2
14627989	2



**Equal Male & Female Elbow Galv.**

PART#	SIZE
14673325	3/8
14673336	1/2
14673347	3/4
14673358	1
14673369	11/4
14673380	11/2
14673391	2

# MALLEABLE IRON THREADED FITTINGS



**Equal Male Elbow Long Sweep Black**

PART#	SIZE
14641432	1/2
14641443	3/4
14641454	1
14641465	1 1/4
14641476	1 1/2
14641487	2



**Equal Male Elbow Long Sweep Galv.**

PART#	SIZE
14676545	1/2
14676556	3/4
14676567	1
14676578	1 1/4
14676589	1 1/2
14676608	2



**Equal Female 45° Elbow Black BSPP**

PART#	SIZE
14628530	1/2
14628541	3/4
14628552	1
14628563	1 1/4
14628574	1 1/2
14628585	2



**Equal Female 45° Elbow Galvanised BSPP**

PART#	SIZE
14673528	1/2
14673539	3/4
14673550	1
14673561	1 1/4
14673572	1 1/2
14673583	2



**Equal Male & Female 45° Elbow Black BSPP**

PART#	SIZE
14628692	1/2
14628700	3/4
14628711	1
14628722	1 1/4
14628733	1 1/2
14628744	2



**Equal Male & Female 45° Elbow Galvanised BSPP**

PART#	SIZE
14673731	1/2
14673742	3/4
14673753	1
14673764	1 1/4
14673775	1 1/2
14673786	2



**Equal Female Tee Black BSPP**

PART#	SIZE
14628903	1/8
14628914	1/4
14628925	3/8
14628936	1/2
14628947	3/4
14628958	1
14628969	1 1/4
14628980	1 1/2
14628991	2
14629008	2 1/2
14629019	3
14629041	4



**Equal Female Tee Galvanised BSPP**

PART#	SIZE
14673901	1/8
14673912	1/4
14673923	3/8
14673934	1/2
14673945	3/4
14673956	1
14673967	1 1/4
14673978	1 1/2
14673989	2
14674006	2 1/2
14674017	3
14674028	4

# MALLEABLE IRON THREADED FITTINGS

150LB THREADED PARTS



**Female Tee Reducing Branch  
Black BSPP**

PART#	SIZE
14629115	(1/2x1/4")
14629137	(1/2x3/8")
14629159	(1/2x3/4")
14629200	(3/4x1/4")
14629211	(3/4x3/8")
14629222	(3/4x1/2")
14629233	(3/4x1")
14629266	(1x1/4")
14629277	(1x3/8")
14629288	(1x1/2")
14629299	(1x3/4")
14629373	(11/4x1/2")



**Female Tee Reducing Branch  
Galvanised BSPP**

PART#	SIZE
14674072	(1/2x1/4")
14674094	(1/2x3/8")
14674113	(1/2x3/4")
14674124	(3/4x1/4")
14674135	(3/4x3/8")
14674146	(3/4x1/2")
14674179	(3/4x1")
14674190	(1x1/4")
14674209	(1x3/8")
14674220	(1x1/2")
14674242	(1x3/4")
14674305	(11/4x1/2")

PART#	SIZE
14674327	(11/4x3/4")
14674349	(11/4x1")
14674423	(11/2x1/2")
14674434	(11/2x3/4")
14674445	(11/2x1")
14674508	(11/2x11/4")
14674574	(2x1/2")
14674585	(2x3/4")
14674596	(2x1")
14674604	(2x11/4")
14674615	(2x11/2")



**Blank Plug  
Black BSPT**

PART#	SIZE
14625609	1/8
14625620	1/4
14625631	3/8
14625642	1/2
14625653	3/4
14625664	1
14625675	11/4
14625686	11/2
14625687	2

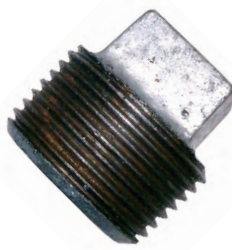

**Blank Plug  
Galvanised BSPT**

PART#	SIZE
14672537	1/8
14672548	1/4
14672559	3/8
14672570	1/2
14672581	3/4
14672592	1
14672600	11/4
14672611	11/2
14672622	2

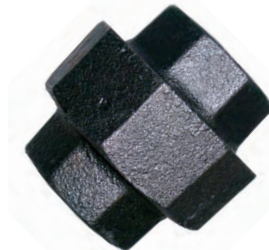

**Female Union  
Iron to Iron Black**

PART#	SIZE
14655509	1/4
14655520	3/8
14655531	1/2
14655542	3/4
14655553	1
14655564	11/4
14655575	11/2
14655586	2
14655597	2/12
14655605	3
14655627	4



**Female Union  
Iron to Iron Galv.**

PART#	SIZE
14677909	1/4
14677920	3/8
14677931	1/2
14677942	3/4
14677953	1
14677964	11/4
14677975	11/2
14677986	2
14677997	2/12
14678003	3
14678014	4



# MALLEABLE IRON THREADED FITTINGS

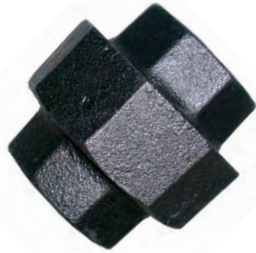

**Female Union  
Bronze to Iron Black**

PART#	SIZE
14657439	1/2
14657450	3/4
14657461	1
14657472	1 1/4
14657483	1 1/2
14657494	2



**Female Union  
Bronze to Iron Galv.**

PART#	SIZE
14678442	1/2
14678453	3/4
14678464	1
14678475	1 1/4
14678486	1 1/2
14678497	2

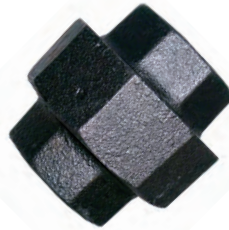

**Female Union  
Bronze to Bronze  
Black Navy Unions**

PART#	SIZE
14659026	1/2
14659037	3/4
14659048	1
14659059	1 1/4
14659070	1 1/2
14659081	2



**Female Union  
Bronze to Bronze  
Galv. Navy Unions**

PART#	SIZE
14678992	1/2
14678933	3/4
14678944	1
14678955	1 1/4
14678966	1 1/2
14678977	2

**DRY BREAK CAM COUPLINGS  
-PAGE 13**



**HIGH PRESSURE AIR  
AND STEAM COUPLINGS  
- PAGE 49**



**PNEUMATIC FILTER  
REGULATORS  
AND LUBRICATORS  
- PAGES 98-99**



# STAINLESS STEEL 316 150LB BSP SCREWED FITTINGS

150LB THREADED PARTS



**Parallel Nipples**

BSP THREAD	PART#
1/8"	PN-0.125
1/4"	PN-0.25
3/8"	PN-0.375
1/2"	PN-0.5
3/4"	PN-0.75
1"	PN-1.0
1-1/4"	PN-1.25
1-1/2"	PN-1.5
2"	PN-2.0
2-1/2"	PN-2.5
3"	PN-3.0
4"	PN-4.0



**Hexagon Reducing Nipple**

BSP THREAD	PART#
1/4"	HRN-0.25-*
3/8"	HRN-0.375-*
1/2"	HRN-0.5-*
3/4"	HRN-0.75-*
1"	HRN-1.0-*
1-1/4"	HRN-1.25-*
1-1/2"	HRN-1.5-*
2"	HRN-2.0-*
2-1/2"	HRN-2.5-*
3"	HRN-3.0-*
4"	HRN-4.0-*

\*The other size



**Weld Nipples**

BSP THREAD	PART#
1/8"	WN-0.125
1/4"	WN-0.25
3/8"	WN-0.375
1/2"	WN-0.5
3/4"	WN-0.75
1"	WN-1.0
1-1/4"	WN-1.25
1-1/2"	WN-1.5
2"	WN-2.0
2-1/2"	WN-2.5
3"	WN-3.0
4"	WN-4.0



**Hexagon Plug**

BSP THREAD	PART#
1/8"	HP-0.125
1/4"	HP-0.25
3/8"	HP-0.375
1/2"	HP-0.5
3/4"	HP-0.75
1"	HP-1.0
1-1/4"	HP-1.25
1-1/2"	HP-1.5
2"	HP-2.0
2-1/2"	HP-2.5
3"	HP-3.0
4"	HP-4.0



**Hexagon Nipples**

BSP THREAD	PART#
1/8"	HN-0.125
1/4"	HN-0.25
3/8"	HN-0.375
1/2"	HN-0.5
3/4"	HN-0.75
1"	HN-1.0
1-1/4"	HN-1.25
1-1/2"	HN-1.5
2"	HN-2.0
2-1/2"	HN-2.5
3"	HN-3.0
4"	HN-4.0



**90° Elbows**

BSP THREAD	PART#
1/8"	S90-0.125
1/4"	S90-0.25
3/8"	S90-0.375
1/2"	S90-0.5
3/4"	S90-0.75
1"	S90-1.0
1-1/4"	S90-1.25
1-1/2"	S90-1.5
2"	S90-2.0
2-1/2"	S90-2.5
3"	S90-3.0
4"	S90-4.0



**Square Head Plugs**

BSP THREAD	PART#
1/8"	SHP-0.125
1/4"	SHP-0.25
3/8"	SHP-0.375
1/2"	SHP-0.5
3/4"	SHP-0.75
1"	SHP-1.0
1-1/4"	SHP-1.25
1-1/2"	SHP-1.5
2"	SHP-2.0
2-1/2"	SHP-2.5
3"	SHP-3.0
4"	SHP-4.0



**Tees**

BSP THREAD	PART#
1/8"	ST-0.125
1/4"	ST-0.25
3/8"	ST-0.375
1/2"	ST-0.5
3/4"	ST-0.75
1"	ST-1.0
1-1/4"	ST-1.25
1-1/2"	ST-1.5
2"	ST-2.0
2-1/2"	ST-2.5
3"	ST-3.0
4"	ST-4.0

# STAINLESS STEEL 316 150LB BSP SCREWED FITTINGS



**45° Elbows**

BSP THREAD	PART#
1/8"	S45-0.125
1/4"	S45-0.25
3/8"	S45-0.375
1/2"	S45-0.5
3/4"	S45-0.75
1"	S45-1.0
1-1/4"	S45-1.25
1-1/2"	S45-1.5
2"	S45-2.0
2-1/2"	S45-2.5
3"	S45-3.0
4"	S45-4.0



**Union Female x Female**

BSP THREAD	PART#
1/8"	SUCS-0.125
1/4"	SUCS-0.25
3/8"	SUCS-0.375
1/2"	SUCS-0.5
3/4"	SUCS-0.75
1"	SUCS-1.0
1-1/4"	SUCS-1.25
1-1/2"	SUCS-1.5
2"	SUCS-2.0
2-1/2"	SUCS-2.5
3"	SUCS-3.0
4"	SUCS-4.0



**Union Male x Female**

BSP THREAD	PART#
1/8"	SUCS-0.125
1/4"	SUCS-0.25
3/8"	SUCS-0.375
1/2"	SUCS-0.5
3/4"	SUCS-0.75
1"	SUCS-1.0
1-1/4"	SUCS-1.25
1-1/2"	SUCS-1.5
2"	SUCS-2.0
2-1/2"	SUCS-2.5
3"	SUCS-3.0
4"	SUCS-4.0



**Equal Crosses**

BSP THREAD	PART#
1/8"	SEX-0.125
1/4"	SEX-0.25
3/8"	SEX-0.375
1/2"	SEX-0.5
3/4"	SEX-0.75
1"	SEX-1.0
1-1/4"	SEX-1.25
1-1/2"	SEX-1.5
2"	SEX-2.0
2-1/2"	SEX-2.5
3"	SEX-3.0
4"	SEX-4.0



**Street Elbows**

BSP THREAD	PART#
1/8"	SE-0.125
1/4"	SE-0.25
3/8"	SE-0.375
1/2"	SE-0.5
3/4"	SE-0.75
1"	SE-1.0
1-1/4"	SE-1.25
1-1/2"	SE-1.5
2"	SE-2.0
2-1/2"	SE-2.5
3"	SE-3.0
4"	SE-4.0



**End Cap**

BSP THREAD	PART#
1/8"	SEC-0.125
1/4"	SEC-0.25
3/8"	SEC-0.375
1/2"	SEC-0.5
3/4"	SEC-0.75
1"	SEC-1.0
1-1/4"	SEC-1.25
1-1/2"	SEC-1.5
2"	SEC-2.0
2-1/2"	SEC-2.5
3"	SEC-3.0
4"	SEC-4.0



**Barrel Nipples**

BSP THREAD	PART#
1/8"	BN-0.125
1/4"	BN-0.25
3/8"	BN-0.375
1/2"	BN-0.5
3/4"	BN-0.75
1"	BN-1.0
1-1/4"	BN-1.25
1-1/2"	BN-1.5
2"	BN-2.0
2-1/2"	BN-2.5
3"	BN-3.0
4"	BN-4.0



**Half Sockets**

BSP THREAD	PART#
1/8"	SHS-0.125
1/4"	SHS-0.25
3/8"	SHS-0.375
1/2"	SHS-0.5
3/4"	SHS-0.75
1"	SHS-1.0
1-1/4"	SHS-1.25
1-1/2"	SHS-1.5
2"	SHS-2.0
2-1/2"	SHS-2.5
3"	SHS-3.0
4"	SHS-4.0

# STAINLESS STEEL 316 150LB BSP SCREWED FITTINGS

150LB THREADED PARTS



### Sockets

BSP THREAD	PART#
1/8"	SS-0.125
1/4"	SS-0.25
3/8"	SS-0.375
1/2"	SS-0.5
3/4"	SS-0.75
1"	SS-1.0
1-1/4"	SS-1.25
1-1/2"	SS-1.5
2"	SS-2.0
2-1/2"	SS-2.5
3"	SS-3.0
4"	SS-4.0



### Hexagon Reducing

BSP THREAD	PART#
1/4"	HRB-0.25-*
3/8"	HRB-0.375-*
1/2"	HRB-0.5-*
3/4"	HRB-0.75-*
1"	HRB-1.0-*
1-1/4"	HRB-1.25-*
1-1/2"	HRB-1.5-*
2"	HRB-2.0-*
2-1/2"	HRB-2.5-*
3"	HRB-3.0-*
4"	HRB-4.0-*

\*The other size



### Hexagon Backnut

BSP THREAD	PART#
1/8"	SHB-0.125
1/4"	SHB-0.25
3/8"	SHB-0.375
1/2"	SHB-0.5
3/4"	SHB-0.75
1"	SHB-1.0
1-1/4"	SHB-1.25
1-1/2"	SHB-1.5
2"	SHB-2.0
2-1/2"	SHB-2.5
3"	SHB-3.0
4"	SHB-4.0



### Hose Connectors

BSP THREAD	PART#
1/8"	HC-0.125
1/4"	HC-0.25
3/8"	HC-0.375
1/2"	HC-0.5
3/4"	HC-0.75
1"	HC-1.0
1-1/4"	HC-1.25
1-1/2"	HC-1.5
2"	HC-2.0
2-1/2"	HC-2.5
3"	HC-3.0
4"	HC-4.0



### Reducing Sockets

BSP THREAD	PART#
1/4"	SRS-0.25-*
3/8"	SRS-0.375-*
1/2"	SRS-0.5-*
3/4"	SRS-0.75-*
1"	SRS-1.0-*
1-1/4"	SRS-1.25-*
1-1/2"	SRS-1.5-*
2"	SRS-2.0-*
2-1/2"	SRS-2.5-*
3"	SRS-3.0-*
4"	SRS-4.0-*

\*The other size



### Hexagon Weldmales (Suitable for use with metal hose)

BSPT		NPT	
PART#	SIZE	PART#	SIZE
0.25WM316	1/4"	0.25WM316NPT	1/4"
0.375WM316	3/8"	0.375WM316NPT	3/8"
0.5WM316	1/2"	0.5WM316NPT	1/2"
0.75WM316	3/4"	0.75WM316NPT	3/4"
1WM316	1"	1WM316NPT	1"
1.25WM316	1.1/4"	1.25WM316NPT	1.1/4"
1.5WM316	1.1/2"	1.5WM316NPT	1.1/2"
2WM316	2"	2WM316NPT	2"

