

Block Clamps

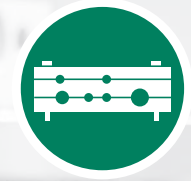

Special Clamps



Light Series



Saddle Clamps



U-Bolt Clamps



Metal Clamps

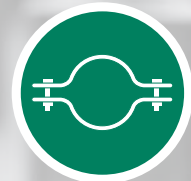

Construction Series



## Germany

### Walter Stauffenberg GmbH & Co. KG

Im Ehrenfeld 4  
58791 Werdohl  
Tel.: +49 2392 91 60  
Fax: +49 2392 91 61 60  
E-Mail: [sales@stauff.com](mailto:sales@stauff.com)  
**[www.stauff.com](http://www.stauff.com)**

STAUFF products and services are globally available through wholly-owned subsidiaries and a tight network of authorised distributors and representatives in all major industrial regions of the world.

**You can find detailed contact information on the last two pages of this product catalogue or at [www.stauff.com](http://www.stauff.com).**

Please note: Unless otherwise stated, all data and figures in this product catalogue are approximate values and are only valid as references, which are not binding (also in respect to any third parties' rights of protection) and thus do not release the customer / user from checking and testing the suitability of the products for the foreseen purposes. Therefore, data and figures can only be used in a limited sense for construction purposes.

The application of the products is beyond the control possibilities of the manufacturer and, therefore, is exclusively subject to the responsibility of the customer / user.

In the event that a liability is nevertheless considered, any compensation will be limited to the value of the goods supplied by the manufacturer and used by the customer / user. As a matter of course, the manufacturer guarantees the perfect quality of all products in accordance with the General Terms and Conditions of Business and Sale.

Subject to modifications due to the ongoing development and improvement of the products.

With the publication of this product catalogue, previous editions are no longer valid.

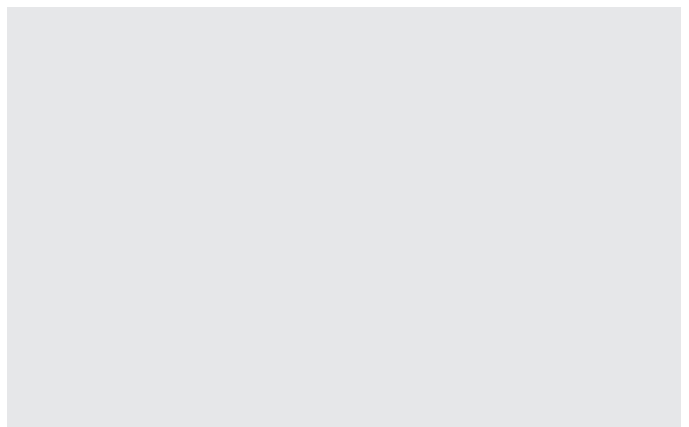
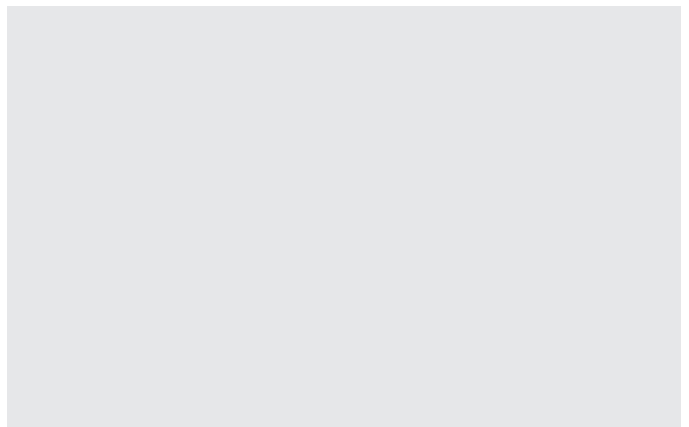

<b>Introduction</b>	<b>4 - 11</b>	
<b>Standard Series according to DIN 3015, Part 1</b>	<b>12 - 33</b>	<b>A</b>
<b>Heavy Series according to DIN 3015, Part 2</b>	<b>34 - 51</b>	<b>B</b>
<b>Twin Series according to DIN 3015, Part 3</b>	<b>52 - 63</b>	<b>C</b>
<b>Heavy Twin Series</b>	<b>64 - 69</b>	<b>D</b>
<b>STAUFF ACT Clamps: Anti-Corrosion Technology</b>	<b>70 - 89</b>	<b>E</b>
<b>STAUFF SWG: Stud Welding System</b>	<b>96 - 101</b>	<b>F</b>
<b>STAUFF Bond: Adhesive Bonded Fastening</b>	<b>96 - 101</b>	<b>G</b>
<b>Custom-Designed Special Clamps</b>	<b>102 - 109</b>	<b>H</b>
<b>Light Series</b>	<b>110 - 119</b>	<b>I</b>
<b>Saddle / Piggyback Clamps</b>	<b>120 - 123</b>	<b>J</b>
<b>Flat Steel and Round Steel U-Bolt Clamps</b>	<b>124 - 133</b>	<b>K</b>
<b>Metal DIN Clamps</b>	<b>134 - 141</b>	<b>L</b>
<b>Construction Series</b>	<b>142 - 145</b>	<b>M</b>
<b>Other Types of Clamps</b>	<b>146 - 151</b>	<b>N</b>
<b>Technical Appendix</b>	<b>152 - 165</b>	<b>O</b>
<b>Appendix (Product-Specific Abbreviations / Global Contact Directory)</b>	<b>166 - 171</b>	





### Catalogue 1 STAUFF Clamps

- Block Clamps
- Special Clamps
- Light Series Clamps
- Saddle Clamps
- U-Bolt Clamps
- Metal Clamps
- Construction Series



### Catalogue 2 STAUFF Connect

- Tube Connectors
- Assembly Tools and Devices

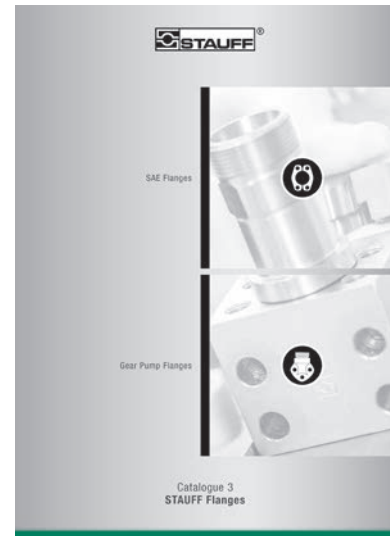

### Catalogue 3 STAUFF Flanges

- SAE Flanges
- Gear Pump Flanges



### Catalogue 4 VOSWINKEL Hose Connectors

- Hose Connectors
- High-Pressure Hose Connectors

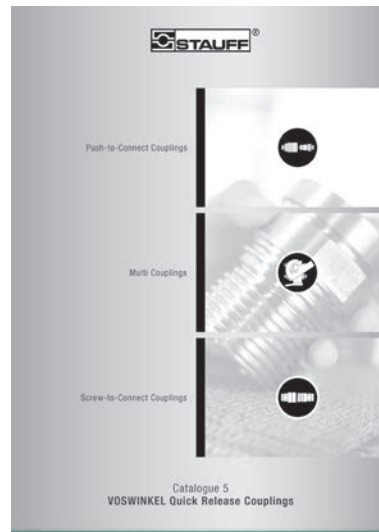

### Catalogue 5 VOSWINKEL Quick Release Couplings

- Push-to-Connect Couplings
- Multi Couplings
- Screw-to-Connect Couplings



### Catalogue 6 STAUFF Valves

- Two-Way Ball Valves
- Multi-Way Ball Valves
- Flow Control and Check Valves
- Gauge Isolator Valves





**Catalogue 7  
STAUFF Test**

- Test Couplings
- Test Adaptors
- Test Hoses and Connectors



**Catalogue 8  
STAUFF Diagtronics**

- Pressure Gauges
- Hydraulic Testers
- Oil Analysis Equipment



**Catalogue 9  
STAUFF Filtration Technology**

- Replacement Filter Elements
- Pressure Filters
- Return-Line Filters
- In-Line Filters
- Spin-On Filters
- Offline and Bypass Filters
- Filtration Systems

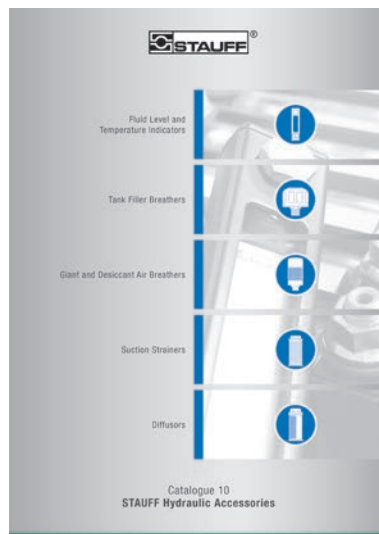

**Catalogue 10  
STAUFF Hydraulic Accessories**

- Fluid Level and Temperature Indicators
- Tank Filler Breathers
- Giant and Desiccant Air Breathers
- Suction Strainers
- Diffusers



For more than 50 years, the companies of STAUFF Group have been developing, manufacturing and distributing pipework equipment and hydraulic components for mechanical and plant engineering and for service and industrial maintenance.

In addition to mobile and industrial hydraulic machinery, typical applications also include commercial and special purpose vehicles, rail transportation and energy technology. Likewise, STAUFF products are used in marine, oil and gas applications and in the process, food and chemical industries.

The overall range currently includes about 40000 standard products as well as numerous special and system solutions according to customer's specifications or based on our in-house development.

All STAUFF products undergo relevant testing in accordance with international regulations and are governed by the high standards of the in-house quality management system. Furthermore, many items have received certifications and approvals from various international institutes, organisations and authorities who have independently confirmed the quality and performance of the products.

Wholly-owned manufacturing, sales and service facilities in 18 countries and a tight global network of authorised distribution partners ensure high presence and service paired with a maximum of availability.



Quality Management – ISO 9001:2015  
Environmental Management – ISO 14001:2015  
Safety Management OHSAS – 18001:2007

## STAUFF LINE Components

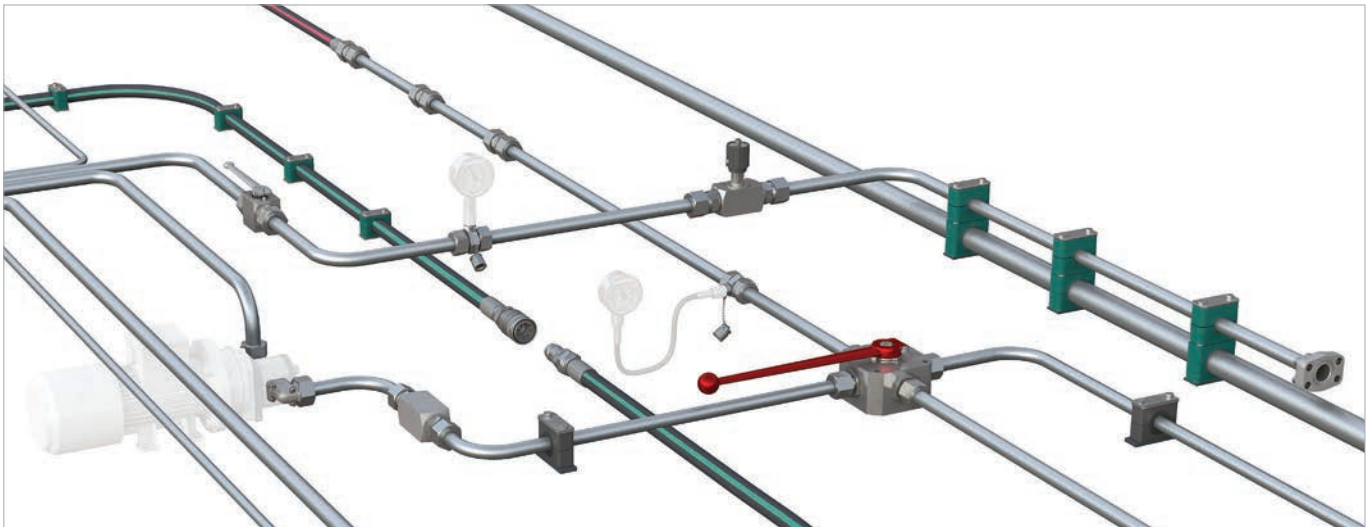

With the seven dedicated **STAUFF Line** product groups

- **STAUFF Clamps**
- **STAUFF Connect**
- **STAUFF Flanges**
- **VOSWINKEL Hose Connectors**
- **VOSWINKEL Quick Release Couplings**
- **STAUFF Valves**
- **STAUFF Test**

from own, in-house development and manufacturing, the companies of the STAUFF Group provide a comprehensive range of components for fastening and connecting pipes, tubes and hoses for mobile and industrial hydraulic applications and many other industries.

The portfolio is completed by components for shutting-off, regulating, throttling and measuring fluid media.

In order to perfectly match each other, STAUFF Line products are designed and offered on a high, uniform level of quality. A large proportion of the range made from steel comes as standard with the premium STAUFF Zinc/Nickel surface coating, which is also optionally available for many of the other components.

This coating offers the most reliable surface protection far beyond the previous market standards – even after transport, handling and assembly of the components – and meets all current legal requirements.

If desired, Original Equipment Manufacturers can be supported with value-added services, from **technical consultation to pre-assembly, assembly and kitting** as well as **logistics services**:

- Support with the **selection of suitable standard components** and ordering options; provision of **customised solutions** according to customer's specifications or based on our in-house development – from prototyping to large scale production
- **Analysis and optimization** of existing and design and developments of new systems aimed at increasing the efficiency and performance of machines and equipment and creating value for customers by reducing the total cost
- **Pre-assembly, assembly and kitting** of individual components to customer-specific system modules
- Individually coordinated **procurement solutions** (e.g. web shop and electronic data interchange) and **supply models** (e.g. from warehousing of customised components to Kanban logistics and just-in-time delivery of pre-fabricated system modules to the assembly lines of the customers) aimed at optimising material flows



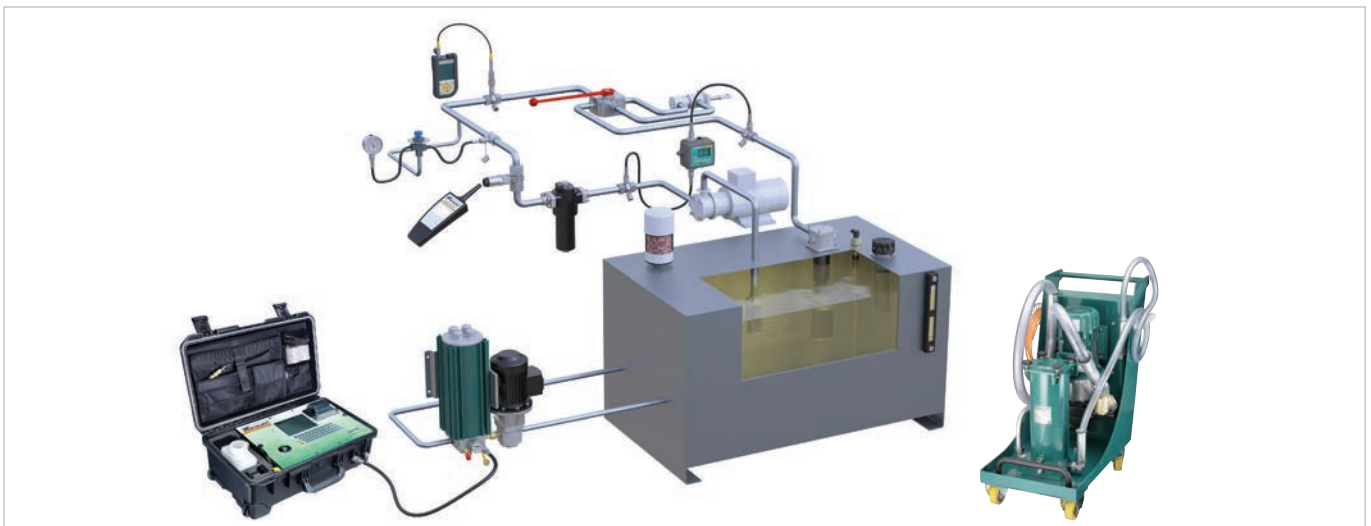

Aligned with the needs of the market, the product groups

- **STAUFF Test**
- **STAUFF Diagtronics**
- **STAUFF Filtration Technology**
- **STAUFF Hydraulic Accessories**

include a comprehensive range of analogue and digital measuring equipment and devices, filtration systems and replacement filter elements as well as accessories for the construction of tanks, reservoirs, power packs and gear boxes in mobile and industrial hydraulics.

The offer is completed by relevant value-added services:

- Support with the **selection of suitable components** and ordering options; provision of **customised solutions** according to customer's specifications or based on our in-house development – from prototyping to large scale production
- Analysis of existing hydraulic circuits aimed at filtration systems, tank components and monitoring devices that perfectly match to the specific requirements, and developing integrated concepts to increase the efficiency and performance of machines and equipment
- Individually coordinated **procurement solutions** and **supply models**



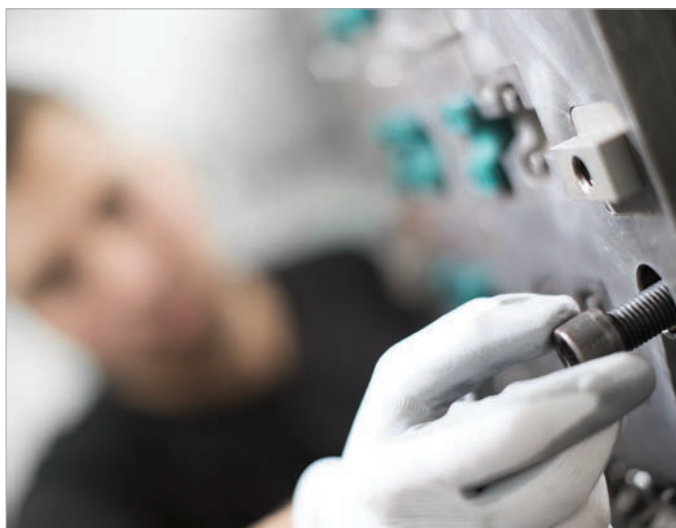
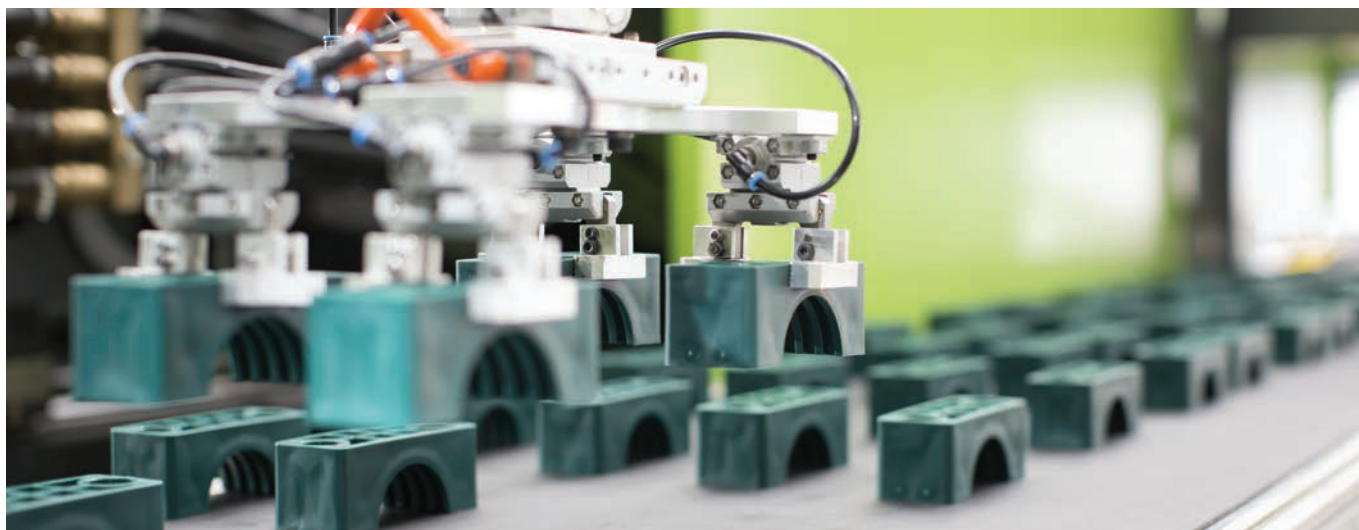

## STAUFF Clamps

For more than 50 years, STAUFF Clamps symbolise quick and easy as well as secure installation of pipes, tubes, hoses, cables and other flexible and rigid components with outside diameters up to 1016 mm / 40.00 inch.

Their vibration and noise reducing features are appreciated as being an important contribution to environmental protection and occupational health and safety.

The processing of fire-proof clamp body materials, tested and approved according to several international fire-protection standards (such as BS 6853, EN 45545-2, UL 94) is only one of the many particular strengths of STAUFF.

STAUFF guarantees prompt service, even for customised solutions according to customer's specifications or based on our in-house development.

For selected types and series, independent certificates and approvals can be provided:

- American Bureau of Shipping
- Bureau Veritas
- Department of the Navy, New York
- Germanischer Lloyd
- Lloyd's Register of Shipping
- Registro Italiano Navale
- Russian Maritime Register of Shipping
- Technischer Überwachungsverein
- United States Coast Guard

For the finishing of the range of pipe, tube, hose and cable clamps as well as metal hardware in carbon steel, STAUFF relies on the STAUFF Zinc/Nickel surface coating which has proven successful for many years. It provides reliable surface protection – even after transport, handling and assembly – and meets all current legal requirements.

Versions in stainless steel V2A and V4A are generally available from stock. Alternative materials and surfaces are available on request.





## STAUFF Zinc/Nickel Coating



### Layers

- Sealing
- Passivation
- Zinc/Nickel
- Steel

With at least 1200 hours resistance against red rust, the STAUFF Zinc/Nickel surface coating offers excellent surface protection – even after transport, handling and assembly. This was confirmed by testing in the salt-spray chamber according to DIN EN ISO 9227.

Users across all industries and applications benefit from sophisticated technology, which has been developed for and used by the very demanding automotive industry for many years now and that is already the proven standard for a large proportion of STAUFF components since 2007.

- At least 1200 hours resistance to red rust / base metal corrosion under practical conditions in the salt-spray chamber according to DIN EN ISO 9227
- White rust occurs only by way of a slight grey haze
- Surpassing the requirements of the corrosion protection class K5 as defined by the VDMA, the German Engineering Association (360 hours resistance to white rust / 720 hours resistance to red rust)
- Free of hexavalent chrome Cr(VI)
- ELV compliant according to 2000/53/EC (End of Life Vehicles Directive)
- REACH compliant according to 1907/2006/EC (Registration, Evaluation, Authorisation and Restriction of Chemicals)
- RoHS compliant according to 2002/95/EC (Restrictions of the Use of Hazardous Substances)
- Appealing colour scheme with a bright semi-gloss surface finish – comparable to Stainless Steel
- Significantly reduced tendency to corrosion by contact with other metals (such as Aluminium and Stainless Steel)
- Improved abrasion resistance due to the ductility / plastic deformability of the coating
- Little to no risk of triggering allergies – nickel release is down to only a fraction of the statutory limits relating to objects which come into direct and prolonged contact with the skin (independent results of the reference test method according to DIN EN 1811 are available on request)
- Good paint adhesion properties
- Resistance against all commonly used hydraulic media





## [www.stauff.com/catalogues](http://www.stauff.com/catalogues)

The STAUFF online catalogue centre at [www.stauff.com/catalogues](http://www.stauff.com/catalogues) provides fast and direct access to digital versions of this as well as other STAUFF product catalogues in all available languages.

### Online Page-Flip Catalogues

- Easy navigation through index or the powerful full text search functionality
- Contents can be shared and forwarded by e-mail, printed or downloaded and saved in PDF file format
- Also suitable for mobile devices

### Download Catalogues

- Download entire product catalogues and save them in PDF file format

### Catalogue Request

- Contact form to request printed copies of the product catalogue as well as digital copies on CD-ROM or USB stick

The fastest way to the online page-flip catalogue:

The links that can be found at the bottom edge of all pages of this product catalogue will lead you directly to the corresponding page in the online page-flip catalogue.

In doing so, contents can be searched, shared and forwarded by e-mail, printed or downloaded and saved in PDF file format.

Scan the QR code next to the direct link with the camera of your mobile device\* and also use the functions in this way.

\* may require a suitable app



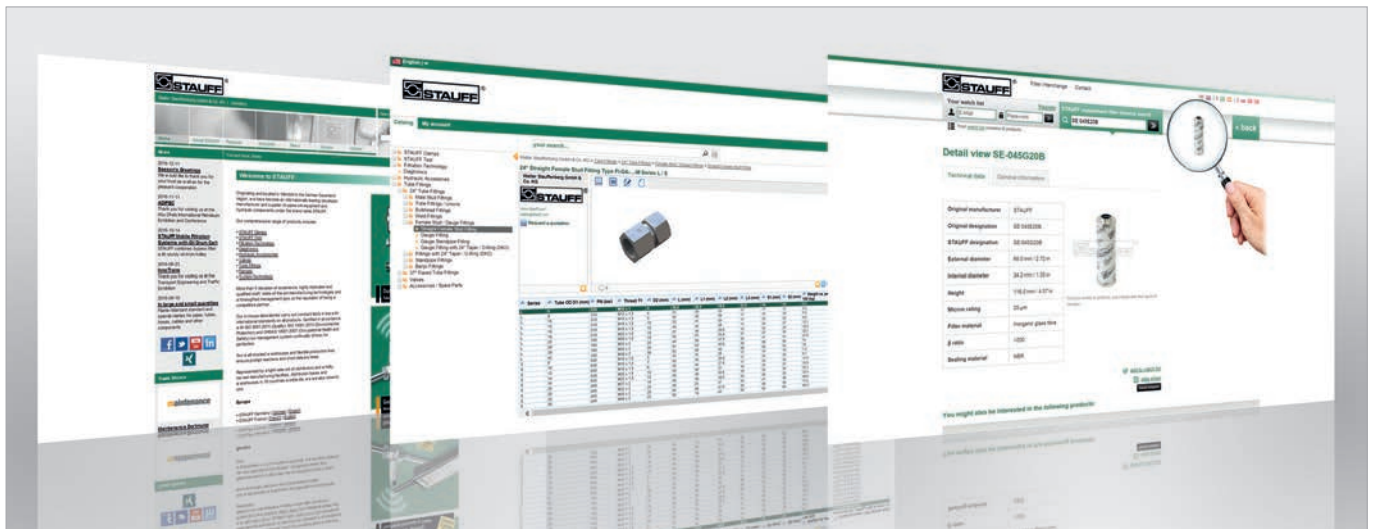

**www.stauff.com**

General information about the companies of STAUFF Group, latest business and product news as well as complete global contact details

**www.stauff.com/cad**

Immediate access to and free download of 3D models and 2D drawings for a growing number of STAUFF products

**www.filterinterchange.com**

Online database for the quick and easy identification and interchange of almost all common brands and types of replacement filter elements

Follow STAUFF and keep yourself updated:



**Facebook**  
www.facebook.com/stauffgroup



**Twitter**  
www.twitter.com/stauffgroup



**LinkedIn**  
www.linkedin.com/company/stauff



**Youtube**  
www.youtube.com/stauffgroup





**Clamp Body**  
Profiled Inside Surface with Tension Clearance

14



**Clamp Body**  
Smooth Inside Surface without Tension Clearance

15



**Clamp Body with Elastomer Insert**

16



**Noise Reduction Clamp**

17



**Clamp Body for Conduit Hoses**

18



**Clamp Body**  
Compact Design for both Compact / Regular Hydraulic Hoses

19



**Clamp Body**  
Rectangular Design for Proximity Switches

19

	<b>Weld Plate</b> SP	20		<b>Cover Plate</b> DP	26
	<b>Elongated Weld Plate</b> SPV	20		<b>Hexagon Head Bolt for use with Cover Plate DP</b> AS	26
	<b>Twin Weld Plate</b> DSP	21		<b>Safety Washer (DIN 93)</b> SI	27
	<b>Group Weld Plate</b> RAP	21		<b>Safety Washer (DIN 463)</b> SI	27
	<b>Angled Weld Plate</b> WSP	22		<b>Socket Cap Screw</b> IS	28
	<b>Bridge Weld Plate</b> BSP	22		<b>Slotted Head Screw</b> LI	28
	<b>Clamp Body for Multi-Group Weld Plates</b>	23		<b>Hexagon Head Bolt for use with Insert ES / EP</b> AS	28
	<b>Multi-Group Weld Plate</b> RAP-MGR	23		<b>Insert</b> ES / EP	28
	<b>Hexagon Rail Nut</b> SM / SMG	24		<b>Safety Locking Plate</b> SIG	29
	<b>Mounting Rail</b> TS	24		<b>Stacking Bolt</b> AF	29
	<b>Channel Rail Adaptor</b> CRA	25		<b>Clamp Assemblies</b>	30



## Clamp Body - Profiled Design

Profiled Inside Surface with Tension Clearance

A

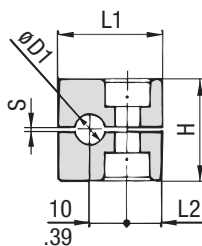
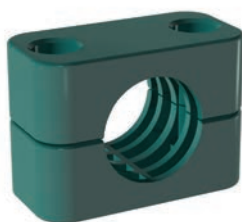

STAUFF Group 1

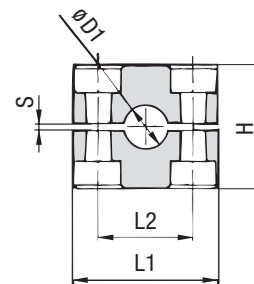

STAUFF Group 1A to 8

### Ordering Codes

#### Clamp Body

Clamp Body, STAUFF Group 1A

\*1\*06-\*PP

\*1\*06A-\*PP

One clamp body is consisting of two clamp halves.

\* STAUFF Group

1

\* Exact outside diameter Ø D1 (mm)

06

\* Material code (see below)

PP

### Standard Materials



**Polypropylene**

Colour: Green  
Material code: **PP**



**Polypropylene**

Colour: Black  
Material code: **PP-BK**



**Polyamide**

Colour: Black  
Material code: **PA**



**Thermoplastic Elastomer (87 Shore-A)**

Colour: Black  
Material code: **SA**



**Aluminium**

Colour: Self-Colour  
Material code: **AL** (STAUFF Group 1A to 6)

See pages 154 / 155 for material properties and technical information.

### Special Materials

Please contact STAUFF for further details on fire-proof clamp body materials, tested and approved according to several international fire-protection standards (such as BS 6853, EN 45545-2, UL 94 and many more).

See pages 156 / 157 for material properties and technical information.

### Product Features

- Proven, tested and trusted product in various markets
- Recommended for the safe installation of rigid pipes and tubes
- Available for all commonly used pipe and tube outside diameters
- Environmental protection due to vibration/noise reducing design
- Excellent weathering resistance, even under extreme conditions

Group	STAUFF	DIN	Outside Diameter Pipe / Tube		Nominal Bore Pipe (in)	Copper Tube ASTM B88 (in)	Ordering Codes (2 Clamp Halves) (** = Material)	Dimensions (mm/in)						
			Ø D1 (mm)	(in)				L1	L2	H	S min.	Width		
1		0	6				106-**							
			6,4	1/4			106.4-**							
			8	5/16			108-**	28	9,5	27	0,4	30		
			9,5	3/8	1/4		109.5-**	1.10	.37	1.06	.02	1.18		
			10		1/8		110-**							
1A		1	6				106A-**							
			6,4	1/4			106.4A-**							
			8	5/16			108A-**	37	20	27	0,4	30		
			9,5	3/8	1/4		109.5A-**	1.46	.79	1.06	.02	1.18		
			10		1/8		110A-**							
2		2	12				112-**							
			12,7	1/2	3/8		212.7-**							
			13,5		1/4		213.5-**							
			14				214-**							
			15				215-**	42	26	33	0,6	30		
3		3	16	5/8	1/2		216-**	1.65	1.02	1.30	.02	1.18		
			17,2		3/8		217.2-**							
			18				218-**							
			19	3/4			319-**							
			20				320-**							
4		4	21,3		1/2		321.3-**	50	33	36	0,6	30		
			22	7/8	3/4		322-**	1.97	1.30	1.42	.02	1.18		
			25				325-**							
			25,4	1			325.4-**							
			26,9		3/4		426.9-**							
5		5	28				428-**							
			28,6		1		428.6-**	59	40	42	0,6	30		
			30				430-**	2.32	1.57	1.65	.02	1.18		
			32				432-**							
			32	1-1/4			532-**							
6		6	33,7		1		533.7-**							
			35			1-1/4	535-**							
			38	1-1/2			538-**	71	52	58	0,8	30		
			40				540-**	2.80	2.05	2.28	.03	1.18		
			41,3		1-1/2		541.3-**							
7		7	42		1-1/4		542-**							
			44,5	1-3/4			644.5-**							
			48,3		1-1/2		648.3-**	86	66	66	0,8	30		
			50,8	2			650.8-**	3.39	2.60	2.60	.03	1.18		
			54		2		654-**							
8		8	57,2	2-1/4			757.2-**							
			60,3		2		760.3-**							
			63,5	2-1/2			763.5-**	121	94	93	0,8	30		
			70	2-3/4			770-**	4.76	3.70	3.66	.03	1.18		
			73		2-1/2 (ANSI B 36-10)		773-**							
8		8	76,1	3	2-1/2 (DIN EN 10220)		776.1-**							
			88,9		3		888.9-**	147	120	118	0,8	30		
			102	4	3-1/2		8102L-**	5.79	4.72	4.65	.03	1.18		

Additional outside diameters are available upon request. Please contact STAUFF for further information.

Dimensional drawings: All dimensions in mm (in).



Clamp Body - Type H

Smooth Inside Surface without Tension Clearance

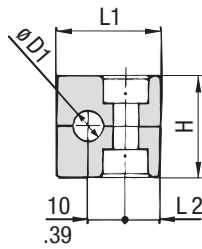

STAUFF Group 1

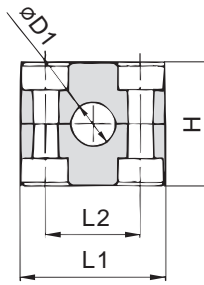

STAUFF Group 1A to 8

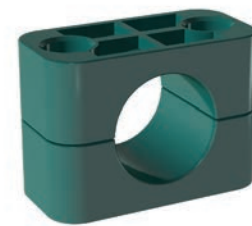

A

Group	STAUFF	DIN	Outside Diameter		Ordering Codes (2 Clamp Halves)	Dimensions (mm/in)			
			Hose Ø D1 (mm)	(in)		(** - H = Material)	L1	L2	H
1	0	6			106-**-H	28	9,5	26	30
		6,4	1/4	106.4-**-H					
		8	5/16	108-**-H					
		9,5	3/8	109.5-**-H					
		10		110-**-H					
		12		112-**-H					
1A	1	6			106A-**-H	37	20	26	30
		6,4	1/4	106.4A-**-H					
		8	5/16	108A-**-H					
		9,5	3/8	109.5A-**-H					
		10		110A-**-H					
		12		112A-**-H					
2	2	12,7	1/2		212.7-**-H	42	26	32	30
		13,5		213.5-**-H					
		14		214-**-H					
		15		215-**-H					
		16	5/8	216-**-H					
		17,2		217.2-**-H					
		18		218-**-H					
3	3	19	3/4		319-**-H	50	33	35,5	30
		20		320-**-H					
		21,3		321.3-**-H					
		22	7/8	322-**-H					
		25		325-**-H					
		25,4	1	325.4-**-H					
4	4	26,9			426.9-**-H	59	40	41,5	30
		28		428-**-H					
		30		430-**-H					
		32		432-**-H					
		32	1-1/4	532-**-H					
5	5	33,7			533.7-**-H	71	52	56,5	30
		35		535-**-H					
		38	1-1/2	538-**-H					
		40		540-**-H					
		42		542-**-H					
		44,5	1-3/4	644.5-**-H					
6	6	48,3			648.3-**-H	86	66	64,5	30
		50,8	2	650.8-**-H					
		54		654-**-H					
		57,2	2-1/4	757.2-**-H					
7	7	60,3			760.3-**-H	121	94	92	30
		63,5	2-1/2	763.5-**-H					
		70	2-3/4	770-**-H					
		73		773-**-H					
		76,1	3	776.1-**-H					
		88,9		888.9-**-H					
8	8	102	4		8102L-**-H	147	120	116	30
						5,79	4,72	4,57	1,18

Additional outside diameters are available upon request. Please contact STAUFF for further information.

Ordering Codes

Clamp Body **\*1\*06-\*PP-H**  
 Clamp Body, STAUFF Group 1A **\*1\*06A-\*PP-H**

One clamp body is consisting of two clamp halves.

- \* STAUFF Group **1**
- \* Exact outside diameter Ø D1 (mm) **06**
- \* Material code (see below) **PP-H**

Standard Materials



**Polypropylene**  
 Colour: Green  
 Material code: **PP-H**



**Polypropylene**  
 Colour: Black  
 Material code: **PP-H-BK**



**Polyamide**  
 Colour: Black  
 Material code: **PA-H**



**Thermoplastic Elastomer (87 Shore-A)**  
 Colour: Black  
 Material code: **SA-H**

See pages 154 / 155 for material properties and technical information.

Special Materials

Please contact STAUFF for further details on fire-proof clamp body materials, tested and approved according to several international fire-protection standards (such as BS 6853, EN 45545-2, UL 94 and many more).

See pages 156 / 157 for material properties and technical information.

Product Features

- Proven, tested and trusted product in various markets
- Recommended for the safe installation of hoses and cables
- Chamfered edges avoid damaging of the hoses and cables
- Available for all commonly used hose and cable outside diameters
- Excellent weathering resistance, even under extreme conditions



## Clamp Body with Elastomer Insert Type RI

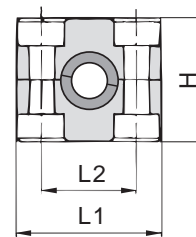
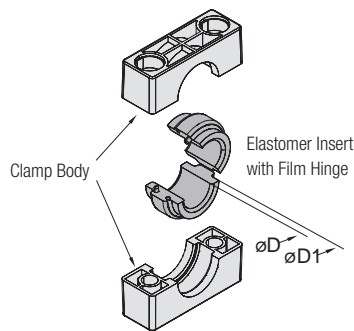

A

### Ordering Codes

#### Clamp Assembly **\*4\*06-\*PP-R**

One assembly is consisting of one clamp body and one insert.

- \* STAUFF Group **4**
- \* Exact outside diameter Ø D (mm) **06**
- \* Material code (see below) **PP-R**

#### Clamp Body **\*4-\*PP-R**

One clamp body is consisting of two clamp halves.

- \* STAUFF Group **4**
- \* Material code (see below) **PP-R**

#### Elastomer Insert **\*RI-\*06-\*4/4S**

- \* Elastomer Insert **RI**
- \* Exact outside diameter Ø D (mm) **06**
- \* STAUFF Group **4 (Standard) and 4S (Heavy) 4/4S**  
**6 (Standard) and 5S (Heavy) 6/5S**

### Standard Materials



**Polypropylene**  
Colour: Black  
Material code: **PP-R**



**Polyamide**  
Colour: Black  
Material code: **PA-R**



Elastomer Insert  
**Thermoplastic Elastomer (73 Shore-A)**  
Colour: Black

See pages 154 / 155 for material properties and technical information.

### Special Materials

Please contact STAUFF for further details on fire-proof clamp body materials, tested and approved according to several international fire-protection standards (such as BS 6853, EN 45545-2, UL 94 and many more).

See pages 156 / 157 for material properties and technical information.

### Product Features

- Proven, tested and trusted product in various markets
- Either for the extra vibration/noise reducing installation of pipes and tubes or the extra gentle installation of hoses and cables
- Available for all commonly used outside diameters
- Excellent weathering resistance, even under extreme conditions

Group	STAUFF	DIN	Outside Diameter Pipe / Tube / Hose		Ordering Codes Clamp Assembly (Clamp Body + Insert)	(**R = Clamp Body Material)			Dimensions (mm/in)					
			Ø D (mm)	(in)		Clamp Body (2 Clamp Halves)	Clamp Body	Insert *	Ø D1	L1	L2	H	Width	
4	4	4	6		406-**-R	4-**-R			RI-06-4/4S	25 .98	59 2.32	40 1.57	41,2 1.62	30 1.18
			8	5/16	408-**-R				RI-08-4/4S					
			10		410-**-R				RI-10-4/4S					
			12		412-**-R				RI-12-4/4S					
			12,7	1/2	412.7-**-R				RI-12.7-4/4S					
			14		414-**-R				RI-14-4/4S					
			15		415-**-R				RI-15-4/4S					
			16	5/8	416-**-R				RI-16-4/4S					
			17,2		417.2-**-R				RI-17.2-4/4S					
			18		418-**-R				RI-18-4/4S					
			19	3/4	419-**-R				RI-19-4/4S					
			6	6	6				20					
21,3		621.3-**-R				RI-21.3-6/5S								
22	7/8	622-**-R				RI-22-6/5S								
25		625-**-R				RI-25-6/5S								
26,9		626.9-**-R				RI-26.9-6/5S								
28		628-**-R				RI-28-6/5S								
30		630-**-R				RI-30-6/5S								
32	1-1/4	632-**-R				RI-32-6/5S								

\* Elastomer Inserts for Standard Series clamp bodies, STAUFF Group 4 also fit into Heavy Series clamp bodies, STAUFF Group 4S. Elastomer Inserts for Standard Series clamp bodies, STAUFF Group 6 also fit into Heavy Series clamp bodies, STAUFF Group 5S.

Additional outside diameters are available upon request. Please contact STAUFF for further information.



Noise Reduction Clamp  
Type NRC

A

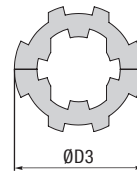
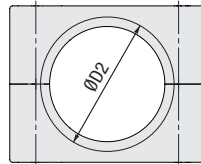
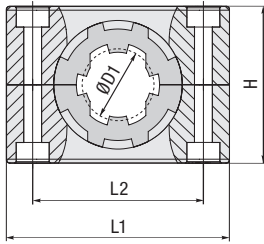

Group	STAUFF	DIN	Outside Diameter		Ordering Codes	Clamp Body	NRC Insert	Dimensions							
			Pipe / Tube	Clamp Assembly				(mm)	(in)	(Clamp Body + NRC Insert)	(2 Clamp Halves)	(2 Insert Halves)	ØD2	ØD3	L1
2	2	2	6		206-PP-NRC	2-PP-NRC	RI-NRC-6-2								
			8	5/16	208-PP-NRC		RI-NRC-8-2								
			10		210-PP-NRC		RI-NRC-10-2	25	26	42	26	32	30		
			12		212-PP-NRC		RI-NRC-12-2	.98	1.02	1.65	1.02	1.26	1.18		
			12,7	1/2	212.7-PP-NRC		RI-NRC-12.7-2								
3	3	3	14		314-PP-NRC	3-PP-NRC	RI-NRC-14-3								
			15		315-PP-NRC		RI-NRC-15-3	28	29	50	33	35,5	30		
			16	5/8	316-PP-NRC		RI-NRC-16-3	1.10	1.14	1.97	1.30	1.40	1.18		
4	4	4	18		418-PP-NRC	4-PP-NRC	RI-NRC-18-4	34	35	59	40	41,5	30		
			20		420-PP-NRC		RI-NRC-20-4	1.34	1.38	2.32	1.57	1.63	1.18		
5	5	5	21,3		521.3-PP-NRC	5-PP-NRC	RI-NRC-21.3-5								
			22	7/8	522-PP-NRC		RI-NRC-22-5								
			25		525-PP-NRC		RI-NRC-25-5								
			26,9		526.9-PP-NRC		RI-NRC-26.9-5	49	50	71	52	56,5	30		
			28		528-PP-NRC		RI-NRC-28-5	1.93	1.97	2.80	2.05	2.22	1.18		
			30		530-PP-NRC		RI-NRC-30-5								
6	6	6	32	1-1/4	532-PP-NRC	RI-NRC-32-5									
			33,7		633.7-PP-NRC	RI-NRC-33.7-6									
			35		635-PP-NRC	RI-NRC-35-6									
			38	1-1/2	638-PP-NRC	RI-NRC-38-6	60	61	86	66	64,5	30			
			40		640-PP-NRC	RI-NRC-40-6	2.36	2.40	3.39	2.60	2.54	1.18			
			42		642-PP-NRC	RI-NRC-42-6									

## Ordering Codes

 Clamp Assembly **\*2\*12-\*PP-NRC**

One assembly is consisting of one clamp body and one insert.

- \* STAUFF Group **2**
- \* Exact outside diameter Ø D1 (mm) **12**
- \* Material code (see below) **PP-NRC**

 NRC Clamp Body **\*2-\*PP-NRC**

One NRC clamp body is consisting of two clamp halves.

- \* STAUFF Group **2**
- \* Material code (see below) **PP-NRC**

 NRC Elastomer Insert **\*RI-NRC-\*12-\*2**

One NRC elastomer insert is consisting of two insert halves.

- \* NRC Elastomer Insert **RI-NRC**
- \* Exact outside diameter ØD1 (mm) **12**
- \* STAUFF Group **2**

## Standard Materials



**Polypropylene**  
Colour: Black  
Material code: **PP-NRC**



**Elastomer Insert**  
**Thermoplastic Elastomer (73 Shore-A)**  
Colour: Black

See pages 154 / 155 for material properties and technical information.

Alternative materials are available upon request. Please contact STAUFF for further information.

## Special Materials

**Please contact STAUFF for further details on fire-proof clamp body materials, tested and approved according to several international fire-protection standards (such as BS 6853, EN 45545-2, UL 94 and many more).**

See pages 156 / 157 for material properties and technical information.

Additional outside diameters are available upon request. Please contact STAUFF for further information.

## Product Features

- Designed for the noise and vibration reducing installation of pipes and tubes
- Suitable for the most common outside diameters from 6 to 42 mm and from ¼ to 1 ½ inch respectively
- Working principle based on a specially shaped, two-part elastomer insert, which mechanically absorbs vibration in the pipe or tube and as a result reduces noises arising to a minimum
- Elastomer insert is in particular distinguished by how little of its surface is in contact with the pipe or tube as well as with the clamp body
- Light tension of the elastomer insert in mounted condition provides the necessary clamping force
- Tongue-groove contour of the elastomer insert and the clamp body (which is reversed and thus diverges from standard DIN 3015 clamps with elastomer insert) enables the system to be used for the maximum range of outside diameters per clamp size, which contributes to flexibility, versatility and optimisation of the required installation space



## Clamp Body for Conduit Hoses Type CHC

A

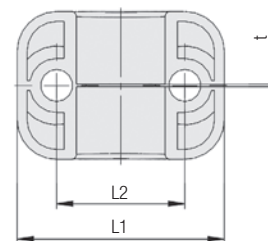
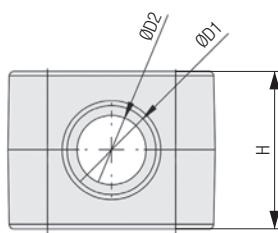

### Ordering Codes

#### Clamp Body

**\*2\*12-\*PA-CHC**

One clamp body is consisting of two clamp halves.

- \* STAUFF Group **2**
- \* Nominal Size of the Conduit Hose **12**
- \* Material code (see below) **PA-CHC**

### Standard Materials



**Polyamide**  
Colour: Black  
Material code: **PA-CHC**

See pages 154 / 155 for material properties and technical information.

### Special Materials

Please contact STAUFF for further details on fire-proof clamp body materials, tested and approved according to several international fire-protection standards (such as BS 6853, EN 45545-2, UL 94 and many more).

See pages 156 / 157 for material properties and technical information.

### Product Features

- Design of the inside surface of the clamp body prevents corrugated conduit hoses from sliding
- Chamfered edges avoid damaging of the conduit hoses
- Available for all commonly used nominal sizes
- Excellent weathering resistance, even under extreme conditions

Group	STAUFF	DIN	Nominal Size Conduit Hose	Ordering Codes (2 Clamp Halves)	Dimensions (mm/in)							
					ØD1	ØD2	t	L1	L2	H	Width	
2	2		10	210-PA-CHC	13	11	0,5	42	26	32	30	
			12	212-PA-CHC	.51	.43	.02	1.65	1.02	1.26	1.18	
3	3		17	317-PA-CHC	16	13,5	0,5	42	26	32	30	
					.63	.53	.02	1.65	1.02	1.26	1.18	
4	4		23	423-PA-CHC	21,5	18	0,7	50	33	35,5	30	
					.85	.71	.03	1.97	1.30	1.40	1.18	
5	5		29	529-PA-CHC	29	24,5	0,7	59	40	41,5	30	
					1.14	.96	.03	2.32	1.57	1.63	1.18	
			36	536-PA-CHC	35	30,5	1,0	71	52	56,5	30	
6	6		48	648-PA-CHC	1.38	1.20	.04	2.80	2.05	2.22	1.18	
					43	38,5	1,0	71	94	92	30	
					1.69	1.52	.04	2.80	2.05	2.22	1.18	
				55	49,5	1,0	86	66	64,5	30		
						2.17	1.95	.51	3.39	2.60	2.54	1.18

Additional outside diameters are available upon request. Please contact STAUFF for further information.



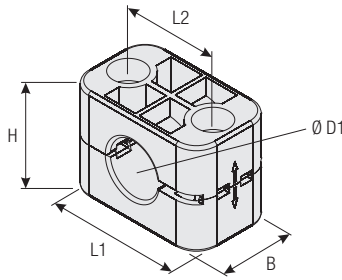

For Use with Regular Hose

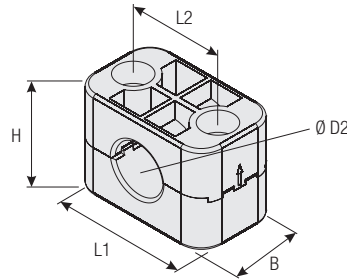

For Use with Compact Hose  
(Upper Clamp Half rotated by 180°)

Group	STAUFF	DIN	Outside Diameter Regular Hose		Outside Diameter Compact Hose		Ordering Codes (2 Clamp Halves)		Dimensions (mm/in)				
			Ø D1 (mm)	(in)	Ø D2 (mm)	(in)	(**-* = Material)	L1	L2	Regular Hose	Compact Hose	B	
3	3	19	.75	17,4	.69	319-**-*-CC-BK							
		22,2	.87	20,6	.81	322.2-**-*-CC-BK	50	33	35,5	34	30		
		25,4	1.00	23,7	.93	325.4-**-*-CC-BK	1.97	1.30	1.40	1.34	1.18		

Additional outside diameters are available upon request. Please contact STAUFF for further information.

### Product Features

- Only one clamp body required for two different hose diameters (compact hose + regular hose)
- Rotate upper clamp half by 180° and use clamp body to fasten compact hoses instead of regular hoses
- Available for three different combinations of outside hose diameters
- Outer dimensions according to DIN 3015, Part 1
- Effective cost reduction due to lower inventories

### Special Materials

Please contact STAUFF for further details on fire-proof clamp body materials, tested and approved according to several international fire-protection standards (such as BS 6853, EN 45545-2, UL 94 and many more).

See pages 156 / 157 for material properties and technical information.

### Ordering Codes

Clamp Body **\*3\*19-\*PP-H-CC-BK**

One clamp body is consisting of two clamp halves.

- \* STAUFF Group **3**
- \* Outside diameter Ø D1 (mm) of regular hose **19**
- \* Material code (see below) **PP-H-CC-BK**

### Standard Materials

**Polypropylene**  
Colour: Black  
Material code: **PP-H-CC-BK**

See pages 154 / 155 for material properties and technical information.

### Ordering Codes

One clamp body is consisting of two clamp halves.

**Clamp Body 540-40-PP-VK**  
Rectangular design with a square of 40 mm x 40 mm / 1.57 in x 1.57 in

**Clamp Body 540-36-PP-VK**  
Rectangular design with a square of 40 mm x 36 mm / 1.57 in x 1.42 in

Please replace PP by PA to order a clamp body made of Polyamide instead of Polypropylene.

### Product Features

- Outer dimensions of clamp body according to Standard Series, STAUFF Group 5
- For proximity switches according to DIN EN 60947-5-2 or similar, rectangular construction, with a square of 40 mm x 40 mm / 1.57 in x 1.57 in or 40 mm x 36 mm / 1.57 in x 1.42 in
- For proximity switches according to DIN EN 60947-5-2 or similar, round construction, please use Standard Series clamp body, STAUFF Group 4, with the diameter required (e.g. 430-PP)
- Use with Hexagon Rail Nut SM and Mounting Rail TS to provide axial and horizontal position adjustment by loosening the bolts

### Clamp Body - Rectangular Design Type VK

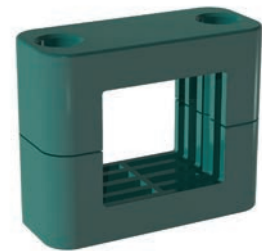

## Single Weld Plate Type SP

A

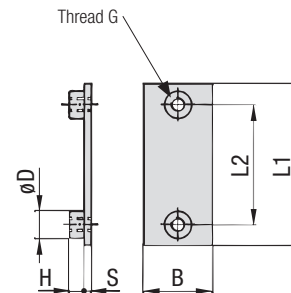
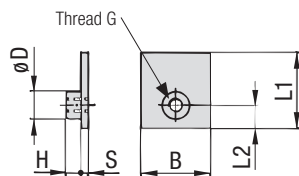
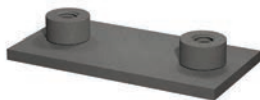

STAUFF Group 1

STAUFF Group 1A to 8

### Ordering Codes

#### Weld Plate

**\*SP-\*1-\*M-\*W2**

- \* Single Weld Plate **SP**
- \* STAUFF Group **1**
- \* Thread code   Metric ISO thread **M**  
                    Unified coarse (UNC) thread **U**
- \* Material code   Carbon Steel, uncoated **W1**  
                    Carbon Steel, phosphated **W2**  
                    Carbon Steel, zinc/nickel-plated **W3**  
  
                    Stainless Steel V2A **W4**  
                    1.4301 / 1.4305 (AISI 304 / 303)  
                    Stainless Steel V4A **W5**  
                    1.4401 / 1.4571 (AISI 316 / 316 Ti)  
  
                    Aluminium EN AW-6060 **W85**  
                    (Dimension S: 5 mm / .20 in)

Group STAUFF	DIN	Dimensions (mm/m)							Ordering Codes (Standard Options)
		Thread G	L1	L2	B	S	H	ØD	
1	0	M6	31,5	10	30	3	6,5	12	SP-1-M-W2
		1/4-20 UNC	1.24	0.39	1.18	.12	.26	.47	SP-1-U-W2
1A	1	M6	36	20	30	3	6,5	12	SP-1A-M-W2
		1/4-20 UNC	1.42	0.79	1.18	.12	.26	.47	SP-1A-U-W2
2	2	M6	42	26	30	3	6,5	12	SP-2-M-W2
		1/4-20 UNC	1.65	1.02	1.18	.12	.26	.47	SP-2-U-W2
3	3	M6	50	33	30	3	6,5	12	SP-3-M-W2
		1/4-20 UNC	1.97	1.30	1.18	.12	.26	.47	SP-3-U-W2
4	4	M6	60	40	30	3	6,5	12	SP-4-M-W2
		1/4-20 UNC	2.36	1.57	1.18	.12	.26	.47	SP-4-U-W2
5	5	M6	71	52	30	3	6,5	12	SP-5-M-W2
		1/4-20 UNC	2.80	2.05	1.18	.12	.26	.47	SP-5-U-W2
6	6	M6	88	66	30	3	6,5	12	SP-6-M-W2
		1/4-20 UNC	3.46	2.60	1.18	.12	.26	.47	SP-6-U-W2
7	7	M6	122	94	30	5	6,5	12	SP-7-M-W2
		1/4-20 UNC	4.80	3.70	1.18	.20	.26	.47	SP-7-U-W2
8	8	M6	148	120	30	5	6,5	12	SP-8-M-W2
		1/4-20 UNC	5.83	4.72	1.18	.20	.26	.47	SP-8-U-W2

All threaded parts are available with Metric ISO thread or unified coarse (UNC) thread according to dimension table. Alternative materials and surface finishings are available upon request. Contact STAUFF for further information.

## Elongated Weld Plate Type SPV

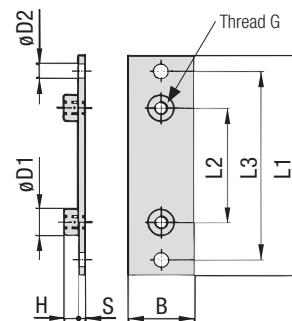
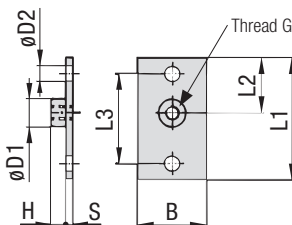
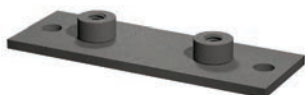

STAUFF Group 1

STAUFF Group 1A to 8

### Ordering Codes

#### Weld Plate

**\*SPV-\*1-\*M-\*W2**

- \* Elongated Weld Plate **SPV**
- \* STAUFF Group **1**
- \* Thread code   Metric ISO thread **M**  
                    Unified coarse (UNC) thread **U**
- \* Material code   Carbon Steel, uncoated **W1**  
                    Carbon Steel, phosphated **W2**  
                    Carbon Steel, zinc/nickel-plated **W3**  
  
                    Stainless Steel V2A **W4**  
                    1.4301 / 1.4305 (AISI 304 / 303)  
                    Stainless Steel V4A **W5**  
                    1.4401 / 1.4571 (AISI 316 / 316 Ti)

Group STAUFF	DIN	Dimensions (mm/m)									Ordering Codes (Standard Options)
		Thread G	L1	L2	L3	B	S	H	ØD1	ØD2	
1	0	M6	58	24,5	44	30	3	6,5	12	6,5	SPV-1-M-W2
		1/4-20 UNC	2.28	.96	1.73	1.18	.12	.26	.47	.26	SPV-1-U-W2
1A	1	M6	64	20	50	30	3	6,5	12	6,5	SPV-1A-M-W2
		1/4-20 UNC	2.52	.79	1.97	1.18	.12	.26	.47	.26	SPV-1A-U-W2
2	2	M6	70	26	56	30	3	6,5	12	6,5	SPV-2-M-W2
		1/4-20 UNC	2.76	1.02	2.20	1.18	.12	.26	.47	.26	SPV-2-U-W2
3	3	M6	78	33	64	30	3	6,5	12	6,5	SPV-3-M-W2
		1/4-20 UNC	3.07	1.30	2.52	1.18	.12	.26	.47	.26	SPV-3-U-W2
4	4	M6	87	40	73	30	3	6,5	12	6,5	SPV-4-M-W2
		1/4-20 UNC	3.43	1.57	2.87	1.18	.12	.26	.47	.26	SPV-4-U-W2
5	5	M6	100	52	86	30	3	6,5	12	6,5	SPV-5-M-W2
		1/4-20 UNC	3.94	2.05	3.39	1.18	.12	.26	.47	.26	SPV-5-U-W2
6	6	M6	115	66	100	30	3	6,5	12	6,5	SPV-6-M-W2
		1/4-20 UNC	4.53	2.60	3.94	1.18	.12	.26	.47	.26	SPV-6-U-W2
7	7	M6	150	94	136	30	5	6,5	12	6,5	SPV-7-M-W2
		1/4-20 UNC	5.91	3.70	5.35	1.18	.20	.26	.47	.26	SPV-7-U-W2
8	8	M6	178	120	162	30	5	6,5	12	6,5	SPV-8-M-W2
		1/4-20 UNC	7.01	4.72	6.38	1.18	.20	.26	.47	.26	SPV-8-U-W2

All threaded parts are available with Metric ISO thread or unified coarse (UNC) thread according to dimension table. Alternative materials and surface finishings are available upon request. Contact STAUFF for further information.



**Twin Weld Plate  
for 2 Clamp Bodies  
Type DSP**

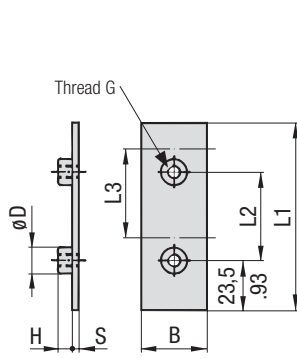

STAUFF Group 1

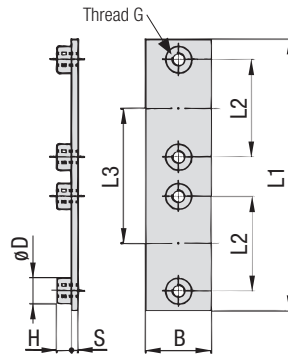

STAUFF Group 1A to 8



Group STAUFF	DIN	Dimensions (mm/in)								Ordering Codes (Standard Options)
		Thread G	L1	L2	L3	B	S	H	ØD	
1	0	M6	87	40	40	30	3	6.5	12	DSP-1-40-M-W2
		1/4-20 UNC	3.43	1.57	1.57	1.18	.12	.26	.47	DSP-1-40-U-W2
1A	1	M6	77	20	37	30	3	6.5	12	DSP-1A-37-M-W2
		1/4-20 UNC	3.03	.79	1.46	1.18	.12	.26	.47	DSP-1A-37-U-W2
2	2	M6	86	26	44	30	3	6.5	12	DSP-2-44-M-W2
		1/4-20 UNC	3.39	1.02	1.73	1.18	.12	.26	.47	DSP-2-44-U-W2
3	3	M6	102	33	52	30	3	6.5	12	DSP-3-52-M-W2
		1/4-20 UNC	4.02	1.30	2.05	1.18	.12	.26	.47	DSP-3-52-U-W2
4	4	M6	120	40	60	30	3	6.5	12	DSP-4-60-M-W2
		1/4-20 UNC	4.72	1.57	2.36	1.18	.12	.26	.47	DSP-4-60-U-W2
5	5	M6	145	52	75	30	3	6.5	12	DSP-5-75-M-W2
		1/4-20 UNC	5.71	2.05	2.95	1.18	.12	.26	.47	DSP-5-75-U-W2
6	6	M6	178	66	90	30	3	6.5	12	DSP-6-90-M-W2
		1/4-20 UNC	7.01	2.60	3.54	1.18	.12	.26	.47	DSP-6-90-U-W2

All threaded parts are available with Metric ISO thread or unified coarse (UNC) thread according to dimension table. Alternative materials and surface finishings are available upon request. Contact STAUFF for further information.

**Ordering Codes**

**Weld Plate \*DSP-\*1-\*40-\*M-\*W2**

- \* Twin Weld Plate for 2 Clamp Bodies **DSP**
- \* STAUFF Group **1**
- \* Pipe center spacing L3 (mm) **40**
- \* Thread code Metric ISO thread **M**  
Unified coarse (UNC) thread **U**
- \* Material code Carbon Steel, uncoated **W1**  
Carbon Steel, phosphated **W2**  
Carbon Steel, zinc/nickel-plated **W3**  
Stainless Steel V2A **W4**  
1.4301 / 1.4305 (AISI 304 / 303) **W4**  
Stainless Steel V4A **W5**  
1.4401 / 1.4571 (AISI 316 / 316 Ti) **W5**

**Group Weld Plate  
for 5 or 10 Clamp Bodies  
Type RAP**

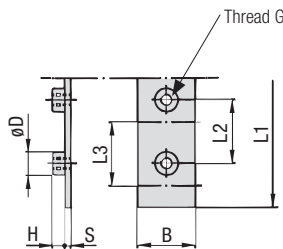

STAUFF Group 1

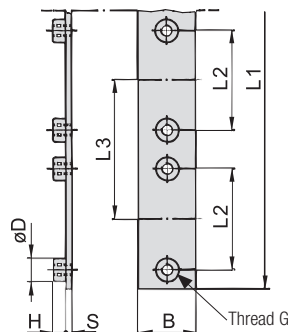

STAUFF Group 1A to 8



Group STAUFF	DIN	Dimensions (mm/in)								Ordering Codes (Standard Options)
		Thread G	L1	L2	L3	B	S	H	ØD	
1	0	M6	314	31	31	30	4	6.5	12	RAP-1-31-10-M-W1
		1/4-20 UNC	12.36	1.22	1.22	1.18	.16	.26	.47	RAP-1-31-10-U-W1
1A	1	M6	373	20	37	30	4	6.5	12	RAP-1A-37-10-M-W1
		1/4-20 UNC	14.69	.79	1.46	1.18	.16	.26	.47	RAP-1A-37-10-U-W1
2	2	M6	442	26	44	30	4	6.5	12	RAP-2-44-10-M-W1
		1/4-20 UNC	17.40	1.02	1.73	1.18	.16	.26	.47	RAP-2-44-10-U-W1
3	3	M6	521	33	52	30	4	6.5	12	RAP-3-52-10-M-W1
		1/4-20 UNC	20.51	1.30	2.05	1.18	.16	.26	.47	RAP-3-52-10-U-W1
4	4	M6	300	40	60	30	4	6.5	12	RAP-4-60-5-M-W1
		1/4-20 UNC	11.81	1.57	2.36	1.18	.16	.26	.47	RAP-4-60-5-U-W1
5	5	M6	378	52	75	30	4	6.5	12	RAP-5-75-5-M-W1
		1/4-20 UNC	14.88	2.05	2.95	1.18	.16	.26	.47	RAP-5-75-5-U-W1
6	6	M6	450	66	90	30	4	6.5	12	RAP-6-90-5-M-W1
		1/4-20 UNC	17.72	2.60	3.54	1.18	.16	.26	.47	RAP-6-90-5-U-W1

All threaded parts are available with Metric ISO thread or unified coarse (UNC) thread according to dimension table. Alternative materials and surface finishings are available upon request. Contact STAUFF for further information.

**Ordering Codes**

**Weld Plate \*RAP-\*1-\*31-\*10-\*M-\*W1**

- \* Group Weld Plate for 5 or 10 Clamp Bodies **RAP**
- \* STAUFF Group **1**
- \* Pipe center spacing L3 (mm) **31**
- \* Number of clamps **10**
- \* Thread code Metric ISO thread **M**  
Unified coarse (UNC) thread **U**
- \* Material code Carbon Steel, uncoated **W1**  
Carbon Steel, phosphated **W2**  
Carbon Steel, zinc/nickel-plated **W3**  
Stainless Steel V2A **W4**  
1.4301 / 1.4305 (AISI 304 / 303) **W4**  
Stainless Steel V4A **W5**  
1.4401 / 1.4571 (AISI 316 / 316 Ti) **W5**

Dimensional drawings: All dimensions in mm (in).



### Angled Weld Plate Type WSP

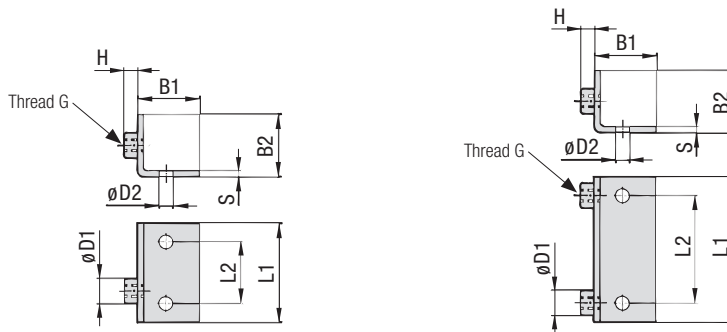

STAUFF Group 1

STAUFF Group 1A to 6

#### Ordering Codes

##### Weld Plate

**\*WSP-\*1-\*M-\*W1**

- \* Angled Weld Plate **WSP**
- \* STAUFF Group **1**
- \* Thread code Metric ISO thread **M**  
Unified coarse (UNC) thread **U**
- \* Material code Carbon Steel, uncoated **W1**  
Carbon Steel, zinc/nickel-plated **W3**  
Stainless Steel V2A **W4**  
1.4301 / 1.4305 (AISI 304 / 303) **W4**  
Stainless Steel V4A **W5**  
1.4401 / 1.4571 (AISI 316 / 316 Ti) **W5**

Group STAUFF	DIN	Dimensions (mm/m)								Ordering Codes (Standard Options)		
		Thread G	L1	L2	B1	B2	S	H	ØD1	ØD2		
1	0	M6	30	14	30	30	3	6,5	12	6,5	<b>WSP-1-M-W1</b>	<b>WSP-1-U-W1</b>
		1/4-20 UNC	1.18	.55	1.18	1.18	.12	.26	.47	.26		
1A	1	M6	36	20	30	30	3	6,5	12	6,5	<b>WSP-1A-M-W1</b>	<b>WSP-1A-U-W1</b>
		1/4-20 UNC	1.26	.79	1.18	1.18	.12	.26	.47	.26		
2	2	M6	42	26	30	30	3	6,5	12	6,5	<b>WSP-2-M-W1</b>	<b>WSP-2-U-W1</b>
		1/4-20 UNC	1.65	1.02	1.18	1.18	.12	.26	.47	.26		
3	3	M6	50	33	30	30	3	6,5	12	6,5	<b>WSP-3-M-W1</b>	<b>WSP-3-U-W1</b>
		1/4-20 UNC	1.97	1.30	1.18	1.18	.12	.26	.47	.26		
4	4	M6	60	40	30	30	3	6,5	12	6,5	<b>WSP-4-M-W1</b>	<b>WSP-4-U-W1</b>
		1/4-20 UNC	2.36	1.57	1.18	1.18	.12	.26	.47	.26		
5	5	M6	70	52	30	30	3	6,5	12	6,5	<b>WSP-5-M-W1</b>	<b>WSP-5-U-W1</b>
		1/4-20 UNC	2.76	2.05	1.18	1.18	.12	.26	.47	.26		
6	6	M6	88	66	30	30	3	6,5	12	6,5	<b>WSP-6-M-W1</b>	<b>WSP-6-U-W1</b>
		1/4-20 UNC	3.46	2.60	1.18	1.18	.12	.26	.47	.26		

All threaded parts are available with Metric ISO thread or unified coarse (UNC) thread according to dimension table. Alternative materials and surface finishings are available upon request. Contact STAUFF for further information.

### Bridge Weld Plate Type BSP

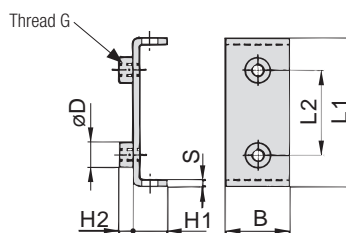

#### Ordering Codes

##### Weld Plate

**\*BSP-\*1A-\*M-\*W1**

- \* Bridge Weld Plate **BSP**
- \* STAUFF Group **1A**
- \* Thread code Metric ISO thread **M**  
Unified coarse (UNC) thread **U**
- \* Material code Carbon Steel, uncoated **W1**  
Carbon Steel, phosphated **W2**  
Carbon Steel, zinc/nickel-plated **W3**  
Stainless Steel V2A **W4**  
1.4301 / 1.4305 (AISI 304 / 303) **W4**  
Stainless Steel V4A **W5**  
1.4401 / 1.4571 (AISI 316 / 316 Ti) **W5**

Group STAUFF	DIN	Dimensions (mm/m)								Ordering Codes (Standard Options)		
		Thread G	L1	L2	B	S	H1	H2	ØD			
1A	1	M6	48	20	30	3	13	6,5	12	6,5	<b>BSP-1A-M-W1</b>	<b>BSP-1A-U-W1</b>
		1/4-20 UNC	1.89	.79	1.18	.12	.52	.26	.47	.26		
2	2	M6	54	26	30	3	13	6,5	12	6,5	<b>BSP-2-M-W1</b>	<b>BSP-2-U-W1</b>
		1/4-20 UNC	2.13	1.02	1.18	.12	.52	.26	.47	.26		
3	3	M6	62	33	30	3	13	6,5	12	6,5	<b>BSP-3-M-W1</b>	<b>BSP-3-U-W1</b>
		1/4-20 UNC	2.44	1.30	1.18	.12	.52	.26	.47	.26		
4	4	M6	71	40	30	3	13	6,5	12	6,5	<b>BSP-4-M-W1</b>	<b>BSP-4-U-W1</b>
		1/4-20 UNC	2.80	1.57	1.18	.12	.52	.26	.47	.26		
5	5	M6	85	52	30	3	13	6,5	12	6,5	<b>BSP-5-M-W1</b>	<b>BSP-5-U-W1</b>
		1/4-20 UNC	3.35	2.05	1.18	.12	.52	.26	.47	.26		
6	6	M6	98	66	30	3	13	6,5	12	6,5	<b>BSP-6-M-W1</b>	<b>BSP-6-U-W1</b>
		1/4-20 UNC	3.86	2.60	1.18	.12	.52	.26	.47	.26		

All threaded parts are available with Metric ISO thread or unified coarse (UNC) thread according to dimension table. Alternative materials and surface finishings are available upon request. Contact STAUFF for further information.



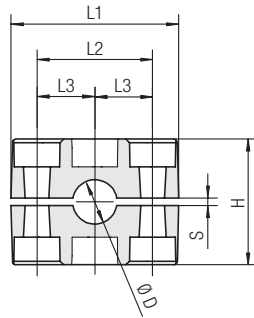

STAUFF Group 5

Group	Outside Diameter Pipe / Tube Ø D	Nominal Bore Pipe	Copper Tube ASTM B88	Ordering Codes (2 Clamp Halves) (** = Material)	Dimensions (mm/in)						
					L1	L2	L3	H	S min.	Width	
5	20			520-**-MGR							
	21,3		1/2	521.3-**-MGR							
	22		3/4	522-**-MGR							
	23			523-**-MGR							
	25			525-**-MGR							
	26,9		3/4	526.9-**-MGR							
	28			528-**-MGR	71	52	26	58	0,8	30	
	30			530-**-MGR	2.80	2.05	1.02	2.28	.03	1.18	
	32	1-1/4		532-**-MGR							
	33,7		1	533.7-**-MGR							
	35			535-**-MGR							
	38	1-1/2		538-**-MGR							
	40			540-**-MGR							
	42		1-1/4	542-**-MGR							

Additional outside diameters are available upon request. Please contact STAUFF for further information.

## Clamp Body for Multi-Group Weld Plate Type MGR

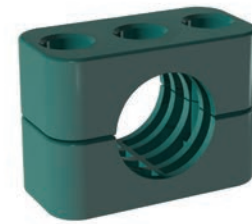

### Ordering Codes

Clamp Body **\*5\*20-PP-MGR**

One clamp body is consisting of two clamp halves.

- \* STAUFF Group **5**
- \* Exact outside diameter Ø D1 (mm) **20**
- \* Material code (see below) **PP-MGR**

### Standard Materials



**Polypropylene**  
Colour: Green  
Material code: **PP-MGR**



**Polyamide**  
Colour: Black  
Material code: **PA-MGR**

See pages 154 / 155 for properties and technical information.

Multi-Group Weld Plates (type RAP-MGR) are designed to be used in combination with Standard Series clamp bodies, STAUFF Group 2 (regular types, see pages 14 ff.) covering a diameter range from 8 mm / .31 in to 18 mm / .71 in, as well as Standard Series clamp bodies, STAUFF Group 5 (type MGR, see above) covering a diameter range from 20 mm / .79 in to 42 mm / 1.65 in. Thus, all Standard Series metal parts (bolts, cover plates) of these groups can be used.



Multi-Group Weld Plate RAP-MGR-25-312-M-W1

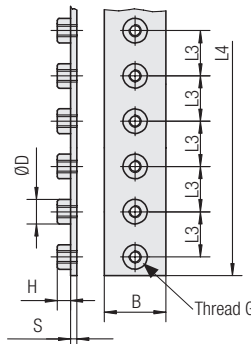

Number of Weld Nuts	Dimensions (mm/in)							Ordering Codes (Standard Options)
	Thread G	L3	L4	B	S	H	ØD	
6	M6	26	156	30	4	6,5	12	RAP-MGR-25-156-M-W1
	1/4-20 UNC	1.02	6.14	1.18	.16	.26	.47	RAP-MGR-25-156-U-W1
9	M6	26	234	30	4	6,5	12	RAP-MGR-25-234-M-W1
	1/4-20 UNC	1.02	9.21	1.18	.16	.26	.47	RAP-MGR-25-234-U-W1
12	M6	26	312	30	4	6,5	12	RAP-MGR-25-312-M-W1
	1/4-20 UNC	1.02	12.28	1.18	.16	.26	.47	RAP-MGR-25-312-U-W1
15	M6	26	390	30	4	6,5	12	RAP-MGR-25-390-M-W1
	1/4-20 UNC	1.02	15.35	1.18	.16	.26	.47	RAP-MGR-25-390-U-W1
20	M6	26	520	30	4	6,5	12	RAP-MGR-25-520-M-W1
	1/4-20 UNC	1.02	20.47	1.18	.16	.26	.47	RAP-MGR-25-520-U-W1
27	M6	26	700	30	4	6,5	12	RAP-MGR-25-700-M-W1
	1/4-20 UNC	1.02	27.55	1.18	.16	.26	.47	RAP-MGR-25-700-U-W1

Cover a diameter range from 8 mm (.31 in) to 42mm (1.65 in) with only one Group Weld Plate!

All threaded parts are available with Metric ISO thread or unified coarse (UNC) thread according to dimension table. Alternative materials and surface finishings are available upon request. Contact STAUFF for further information.

## Multi-Group Weld Plate for Clamp Body Sizes 2 and 5 (Type MGR) Type RAP-MGR



### Ordering Codes

Weld Plate **\*RAP-MGR-25-156-M-W1**

- \* Multi Group Weld Plate **RAP-MGR**
- \* Suitable for STAUFF Group 2 and 5 **25**
- \* Length L4 (mm)
 

156 (with 6 weld nuts)	<b>156</b>
234 (with 9 weld nuts)	<b>234</b>
312 (with 12 weld nuts)	<b>312</b>
390 (with 15 weld nuts)	<b>390</b>
520 (with 20 weld nuts)	<b>520</b>
700 (with 27 weld nuts)	<b>700</b>
- \* Thread code
 

Metric ISO thread	<b>M</b>
Unified coarse (UNC) thread	<b>U</b>
- \* Material code
 

Carbon Steel, uncoated	<b>W1</b>
Stainless Steel V4A 1.4401 / 1.4571 (AISI 316 / 316 Ti)	<b>W5</b>



### Hexagon Rail Nut

(for Use with Mounting Rail TS)

Type SM / SMG

A

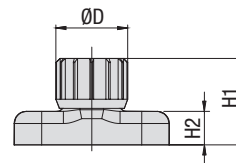
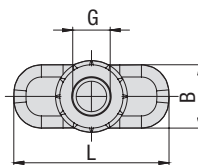

#### Ordering Codes

**Hexagon Rail Nut \*SM-\*1-8/1D-\*M-\*W3**

\* Hexagon Rail Nut

Carbon Steel **SM**  
Stainless Steel **SMG**

\* STAUFF Group 1 to 8 (DIN Group 0 to 8) **1-8/1D**

\* Thread code Metric ISO thread **M**  
Unified coarse (UNC) thread **U**

\* Material code Carbon Steel, zinc/nickel-plated **W3**  
Stainless Steel V2A **W4**  
1.4301 / 1.4305 (AISI 304 / 303)  
Stainless Steel V4A **W5**  
1.4401 / 1.4571 (AISI 316 / 316 Ti)

Group STAUFF	DIN	Dimensions (mm/m)						Ordering Codes (Standard Options)
		Thread G	L	B	H1	H2	ØD	
1	0							
1A	1							
2	2							
3	3							
4	4	M6	25,5	10,4	14,2	5,5	12	SM-1-8/1D-M-W3
		1/4-20 UNC	1.00	.41	.56	.22	.47	SM-1-8/1D-U-W3
5	5							
6	6							
7	7							
8	8							

Hexagon Rail Nuts, type SM-1-8/1D are also suitable for Twin Series, STAUFF Group 1D.

All threaded parts are available with Metric ISO thread or unified coarse (UNC) thread according to dimension table. Alternative materials and surface finishings are available upon request. Contact STAUFF for further information.

### Mounting Rail

(for Use with Hexagon Rail Nut SM / SMG)

Type TS

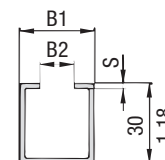
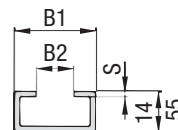
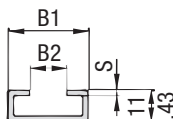

Mounting Rail TS-11

Mounting Rail TS-14

Mounting Rail TS-30

#### Ordering Codes

**Mounting Rail \*TS-\*11-\*1M-\*W1**

\* Mounting Rail

**TS**

\* Height of rail 11 mm / .43 in **11**  
14 mm / .55 in **14**  
30 mm / 1.18 in **30**

\* Length of rail 1 m / 3.28ft **1M**  
2 m / 6.56ft **2M**

Alternative lengths available upon request. Contact STAUFF for further information.

\* Material code Carbon Steel, uncoated **W1**  
Carbon Steel, hot-dip galvanised **W98**  
Stainless Steel V2A **W4**  
1.4301 / 1.4305 (AISI 304 / 303)  
Stainless Steel V4A **W5**  
1.4401 / 1.4571 (AISI 316 / 316 Ti)

Group STAUFF	DIN	Dimensions (mm/m)			Ordering Codes (Standard Options)	
		B1	B2	S	Length of Rail: 1 m / 3.28ft	Length of Rail: 2 m / 6.56ft
1	0					
1A	1				Height 11 mm / .43 in TS-11-1M-W1	Height 11 mm / .43 in TS-11-2M-W1
2	2					
3	3					
4	4	28	11	2	Height 14 mm / .55 in TS-14-1M-W1	Height 14 mm / .55 in TS-14-2M-W1
		1.10	.43	.08		
5	5					
6	6					
7	7				Height 30 mm / 1.18 in TS-30-1M-W1	Height 30 mm / 1.18 in TS-30-2M-W1
8	8					

Mounting Rails, type TS-11/14/30 are suitable for all Standard Series and Twin Series group sizes. Alternative materials and surface finishings are available upon request. Contact STAUFF for further information.



**Channel Rail Adaptor**  
(for Use with Various Channel Rails)  
**Type CRA**

A

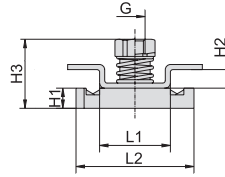
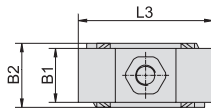

Group STAUFF	DIN	Dimensions (mm/in)									Ordering Codes (Standard Options)	
		Thread G	L1	L2	L3	B1	B2	H1	H2	H3		
1	0											
1A	1											
2	2											
3	3											
4	4	M6	21	35	40	16	19	6	5,5	20,5	CRA-1-8/1D-M-W3 CRA-1-8/1D-U-W3	
		1/4-20 UNC	.83	1.38	1.57	.63	.75	.24	.22	.81		
5	5											
6	6											
7	7											
8	8											

**Ordering Codes**

**Adaptor** \*CRA-\*1-8/1D-\*M-\*W3

- \* Channel Rail Adaptor **CRA**
- \* STAUFF Group 1 to 8 (DIN Group 0 to 8) **1-8/1D**
- \* Thread code Metric ISO thread **M**  
Unified coarse (UNC) thread **U**
- \* Material code Carbon Steel, zinc/nickel-plated **W3**  
Stainless Steel V4A 1.4401 / 1.4571 (AISI 316 / 316 Ti) **W5**

The Channel Rail Adaptor, type CRA 1-8/1D is also suitable for Twin Series, STAUFF Group 1D.

All threaded parts are available with Metric ISO thread or unified coarse (UNC) thread according to dimension table. Alternative materials and surface finishings are available upon request. Contact STAUFF for further information.



**Compatibility with Channel Rails**

The STAUFF Channel Rail Adaptor, type CRA, is suitable for various channel rails, including the following types:

HALFEN	HILTI	UNISTRUT®	STAUFF (Cushion Clamp Series)
HM 41/41	MQ-21, MQ-41, MQ-52, MQ-72	P1000, P1000T, P1000V, P1000VT, P1001	SCS-048-1-PL, SCS-048-1-GR
HZA 41/22	MQ-21U, MQ-41U, MQ-72U	P2000, P2000T	SCS-120-1-PL, SCS-120-1-GR
HZM 41/41	MQ-21D, MQ-41D, MQ-52-72D	P3003, P3003T, P3300V, P3300VT, P3301	See page 149 for technical information.
HZM 41/22		P4000, P4000T	
HL 41/41, HL 41/B2		P5000, P5000T, P5001, P5500, P5500T, P5501	

Contact STAUFF to check compatibility with additional types of channel rails.

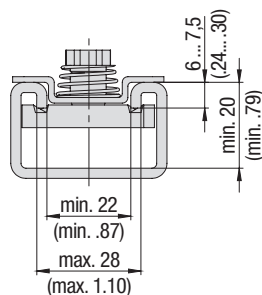

Basic dimensional requirements for channel rails to be used with STAUFF Channel Rail Adaptors, type CRA

Dimensional drawings: All dimensions in mm (in).



**Cover Plate**  
**Type DP**

A

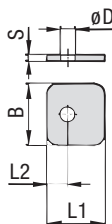

STAUFF Group 1

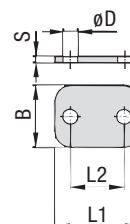

STAUFF Group 1A to 8

**Ordering Codes**

**Cover Plate**

**\*DP-\*1-\*W3**

* Cover Plate	DP
* STAUFF Group	1
* Material code	Carbon Steel, zinc/nickel-plated <b>W3</b>
	Stainless Steel V2A <b>W4</b>
	1.4301 / 1.4305 (AISI 304 / 303)
	Stainless Steel V4A <b>W5</b>
	1.4401 / 1.4571 (AISI 316 / 316 Ti)
	Aluminium EN AW-6060 <b>W85</b>

Group STAUFF	DIN	Dimensions (mm/m)					Ordering Codes (Standard Options)
		L1	L2	B	S	ØD	
1	0	28	9,5	30	3	7	DP-1-W3
		1.10	.37	1.18	.12	.28	
1A	1	34	20	30	3	7	DP-1A-W3
		1.34	.79	1.18	.12	.28	
2	2	40,5	26	30	3	7	DP-2-W3
		1.59	1.02	1.18	.12	.28	
3	3	48	33	30	3	7	DP-3-W3
		1.89	1.30	1.18	.12	.28	
4	4	57	40	30	3	7	DP-4-W3
		2.24	1.57	1.18	.12	.28	
5	5	70	52	30	3	7	DP-5-W3
		2.76	2.05	1.18	.12	.28	
6	6	86	66	30	3	7	DP-6-W3
		3.39	2.60	1.18	.12	.28	
7	7	118	94	30	5	7	DP-7-W3
		4.65	3.70	1.18	.20	.28	
8	8	144	120	30	5	7	DP-8-W3
		5.67	4.72	1.18	.20	.28	

Alternative materials and surface finishings are available upon request. Contact STAUFF for further information.

**Hexagon Head Bolt**

(for Use with Cover Plate DP)

**Type AS**

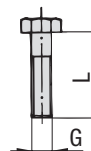

Hexagon Head Bolt AS (according to DIN 931 / 933 or ANSI / ASME B18.2.1.)

Dimensions applicable only when used with Cover Plate DP

**Ordering Codes**

**Hexagon Head Bolt**

**\*AS-\*M6x30-\*W3**

* Type of bolt	Hexagon Head Bolt	<b>AS</b>
	(according to DIN 931 / 933 or ANSI / ASME B18.2.1.)	
* Thread type and size acc. to dimension table	<b>M6x30</b>	
* Material code	Carbon Steel, zinc/nickel-plated <b>W3</b>	
	Stainless Steel V2A <b>W4</b>	
	1.4301 / 1.4305 (AISI 304 / 303)	
	Stainless Steel V4A <b>W5</b>	
	1.4401 / 1.4571 (AISI 316 / 316 Ti)	

Group STAUFF	DIN	Dimensions (mm/m)		Ordering Codes (Standard Options)
		Thread G x L		
1	0	M6 x 30		AS-M6x30-W3
		1/4-20 UNC x 1-1/4		AS-1/4-20UNCx1-1/4-W3
1A	1	M6 x 30		AS-M6x30-W3
		1/4-20 UNC x 1-1/4		AS-1/4-20UNCx1-1/4-W3
2	2	M6 x 35		AS-M6x35-W3
		1/4-20 UNC x 1-3/8		AS-1/4-20UNCx1-3/8-W3
3	3	M6 x 40		AS-M6x40-W3
		1/4-20 UNC x 1-1/2		AS-1/4-20UNCx1-1/2-W3
4	4	M6 x 45		AS-M6x45-W3
		1/4-20 UNC x 1-7/8		AS-1/4-20UNCx1-7/8-W3
5	5	M6 x 60		AS-M6x60-W3
		1/4-20 UNC x 2-3/8		AS-1/4-20UNCx2-3/8-W3
6	6	M6 x 70		AS-M6x70-W3
		1/4-20 UNC x 2-3/4		AS-1/4-20UNCx2-3/4-W3
7	7	M6 x 100		AS-M6x100-W3
		1/4-20 UNC x 4		AS-1/4-20UNCx4-W3
8	8	M6 x 125		AS-M6x125-W3
		1/4-20 UNC x 4-7/8		AS-1/4-20UNCx4-7/8-W3

All threaded parts are available with Metric ISO thread or unified coarse (UNC) thread according to dimension table. Alternative materials and surface finishings are available upon request. Contact STAUFF for further information.



**Safety Washer**  
(for Use with Hexagon Head Bolt AS)  
Type SI (DIN 93)

A

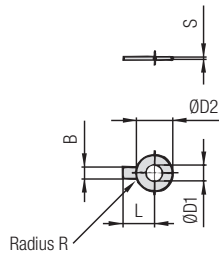

**Safety Washer SI**

(Bend longer tab down towards the side of the clamp body and one side up towards one of the flats of the hexagon head bolt)

Group STAUFF	DIN	Dimensions (mm/m)						Ordering Codes (Standard Options)
		ØD1	B	ØD2	L	R	S	
1 to 8	0 to 8	6,4	7	19	18	4	0,5	SI-6.4-DIN93-W3
		.25	.28	.75	.71	.16	.02	

Safety Washers, type SI are used as locking devices to prevent Hexagon Head Bolts, type AS from loosening. Safety Washers, type SI are suitable for all Standard Series group sizes.

Alternative materials and surface finishings are available upon request. Contact STAUFF for further information.

**Ordering Codes**

**Safety Washer \*SI-\*6.4-\*DIN93-\*W3**

- \* Type of washer Safety washer with 1 tab (according to DIN 93) **SI-6.4-DIN93**
- \* Material code Carbon Steel, zinc/nickel-plated **W3**  
Stainless Steel V4A **W5**  
1.4401 / 1.4571 (AISI 316 / 316 Ti)

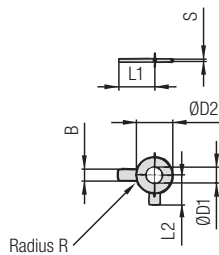

**Safety Washer**  
(for Use with Hexagon Head Bolt AS)  
Type SI (DIN 463)



**Safety Washer SI**

(Bend longer tab down towards the side of the clamp body and shorter tab up towards one of the flats of the hexagon head bolt)

Group STAUFF	DIN	Dimensions (mm/m)						Ordering Codes (Standard Options)	
		ØD1	B	ØD2	L1	L2	R		S
1 to 8	0 to 8	6,4	7	12	18	9	4	0,5	SI-6.4-DIN463-W3
		.25	.28	.47	.71	.35	.16	.02	

Safety Washers, type SI are used as locking devices to prevent Hexagon Head Bolts, type AS from loosening. Safety Washers, type SI are suitable for all Standard Series group sizes.

Alternative materials and surface finishings are available upon request. Contact STAUFF for further information.

**Ordering Codes**

**Safety Washer \*SI-\*6.4-\*DIN463-\*W3**

- \* Type of washer Safety washer with 2 tabs (according to DIN 463) **SI-6.4-DIN463**
- \* Material code Carbon Steel, zinc/nickel-plated **W3**  
Stainless Steel V4A **W5**  
1.4401 / 1.4571 (AISI 316 / 316 Ti)



**Socket Cap Screw**   **Slotted Head Screw**  
**Type IS**   **Type LI**

A

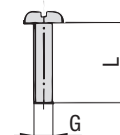
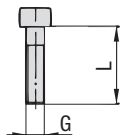

**Socket Cap Screw IS**

(according to ISO 4762 or ANSI / ASME B18.3)

Dimensions applicable only when used without Cover Plate DP

**Slotted Head Screw LI**

(according to ISO 1207 or ANSI / ASME B18.6.3)

Dimensions applicable only when used without Cover Plate DP

**Ordering Codes**

**Socket Cap Screw**   **\*IS-\*M6x30-\*W3**  
**Slotted Head Screw**   **\*LI-\*M6x30-\*W3**

\* Type of bolt   **IS**   Socket Cap Screw (according to ISO 4762 or ANSI / ASME B18.3)  
**LI**   Slotted Head Screw (according to ISO 1207 or ANSI / ASME B18.6.3)

Please note:   Socket cap screws IS and slotted head screws LI have to be used in conjunction with washers US, which are available separately.

\* Thread type and size acc. to dimension table   **M6x30**

\* Material code   Carbon Steel, zinc/nickel-plated   **W3**  
Stainless Steel V2A   **W4**  
1.4301 / 1.4305 (AISI 304 / 303)  
Stainless Steel V4A   **W5**  
1.4401 / 1.4571 (AISI 316 / 316 Ti)

Group STAUFF	DIN	Dimensions (mm/in) Thread G x L	Ordering Codes (Standard Options)	
			Socket Cap Screws	Slotted Head Screws
1	0	M6 x 20	IS-M6x20-W3	LI-M6x20-W3
		1/4-20 UNC x 3/4	IS-1/4-20UNCx3/4-W3	LI-1/4-20UNCx3/4-W3
1A	1	M6 x 20	IS-M6x20-W3	LI-M6x20-W3
		1/4-20 UNC x 3/4	IS-1/4-20UNCx3/4-W3	LI-1/4-20UNCx3/4-W3
2	2	M6 x 25	IS-M6x25-W3	LI-M6x25-W3
		1/4-20 UNC x 1	IS-1/4-20UNCx1-W3	LI-1/4-20UNCx1-W3
3	3	M6 x 30	IS-M6x30-W3	LI-M6x30-W3
		1/4-20 UNC x 1-1/8	IS-1/4-20UNCx1-1/8-W3	LI-1/4-20UNCx1-1/8-W3
4	4	M6 x 35	IS-M6x35-W3	LI-M6x35-W3
		1/4-20 UNC x 1-3/8	IS-1/4-20UNCx1-3/8-W3	LI-1/4-20UNCx1-3/8-W3
5	5	M6 x 50	IS-M6x50-W3	LI-M6x50-W3
		1/4-20 UNC x 2	IS-1/4-20UNCx2-W3	LI-1/4-20UNCx2-W3
6	6	M6 x 60	IS-M6x60-W3	LI-M6x60-W3
		1/4-20 UNC x 2-1/2	IS-1/4-20UNCx2-1/2-W3	LI-1/4-20UNCx2-1/2-W3
7	7	M6 x 90	IS-M6x90-W3	ON REQUEST ONLY
		1/4-20 UNC x 3-3/8	IS-1/4-20UNCx3-3/8-W3	
8	8	M6 x 110	IS-M6x110-W3	ON REQUEST ONLY
		1/4-20 UNC x 4-3/8	IS-1/4-20UNCx4-3/8-W3	

All threaded parts are available with Metric ISO thread or unified coarse (UNC) thread according to dimension table. Alternative materials and surface finishings are available upon request. Contact STAUFF for further information.

**Hexagon Head Bolt**  
**Type AS**

**Insert**  
**Type ES / EP**

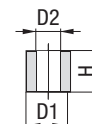
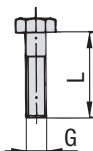
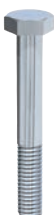

**Hexagon Head Bolt AS**

(according to DIN 931 / 933 or ANSI / ASME B18.2.1.)

Dimensions applicable only when used with Inserts EP / ES

**Insert EP (Polypropylene)**

**Insert ES-W3 (Steel, zinc/nickel-plated)**

**Insert ES-W5 (Stainless Steel V4A)**

**Ordering Codes**

**Hexagon Head Bolt**   **\*AS-\*M6x27-\*W3**

\* Type of bolt   Hexagon Head Bolt (according to DIN 931 / 933 or ANSI / ASME B18.2.1.)   **AS**

\* Thread type and size acc. to dimension table   **M6x27**

\* Material code   Carbon Steel, zinc/nickel-plated   **W3**  
Stainless Steel V2A   **W4**  
1.4301 / 1.4305 (AISI 304 / 303)  
Stainless Steel V4A   **W5**  
1.4401 / 1.4571 (AISI 316 / 316 Ti)

Group STAUFF	DIN	Dimensions (mm/in) Thread G x L	Ordering Codes (Standard Options)	
			AS	AS
1	0	M6 x 27	AS-M6x27-W3	
		1/4-20 UNC x 1-1/8	AS-1/4-20UNCx1-1/8-W3	
1A	1	M6 x 27	AS-M6x27-W3	
		1/4-20 UNC x 1-1/8	AS-1/4-20UNCx1-1/8-W3	
2	2	M6 x 32	AS-M6x32-W3	
		1/4-20 UNC x 1-3/8	AS-1/4-20UNCx1-3/8-W3	
3	3	M6 x 35	AS-M6x35-W3	
		1/4-20 UNC x 1-3/8	AS-1/4-20UNCx1-3/8-W3	
4	4	M6 x 42	AS-M6x42-W3	
		1/4-20 UNC x 1-5/8	AS-1/4-20UNCx1-5/8-W3	
5	5	M6 x 57	AS-M6x57-W3	
		1/4-20 UNC x 2-3/8	AS-1/4-20UNC-2-3/8-W3	
6	6	M6 x 65	AS-M6x65-W3	
		1/4-20 UNC x 2-3/4	AS-1/4-20UNCx2-3/4-W3	
7	7	M6 x 95	AS-M6x95-W3	
		1/4-20 UNC x 4	AS-1/4-20UNCx4-W3	
8	8	M6 x 118	AS-M6x118-W3	
		1/4-20 UNC x 4-3/4	AS-1/4-20UNCx4-3/4-W3	

Group STAUFF	DIN	Dimensions (mm/in)				Ordering Codes (Standard Options)	
		D1	D2	H ES	H EP	ES-W3	EP
1 to 8	0 to 8	11,8 .46	6,5 .26	7,8 .31	8,6 .34	ES-W3	EP

All threaded parts are available with Metric ISO thread or unified coarse (UNC) thread according to dimension table. Alternative materials and surface finishings are available upon request. Contact STAUFF for further information.



**Safety Locking Plate**  
(for Use with Stacking Bolt AF)  
**Type SIG**

A

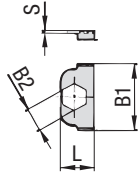

STAUFF Group 1

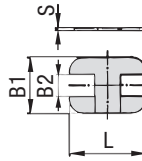

STAUFF Group 1A to 8



Group STAUFF	DIN	Dimensions (mm/in)				Ordering Codes (Standard Options)
		L	B1	B2	S	
1	0	16	32	11,2	1	SIG-1-W3
		.63	1.26	.44	.04	
1A	1	33	28	11,2	1	SIG-1A-W3
		1.30	1.10	.44	.04	
2	2	39	28	11,2	1	SIG-2-W3
		1.54	1.10	.44	.04	
3	3	47	28	11,2	1	SIG-3-W3
		1.85	1.10	.44	.04	
4	4	56	28	11,2	1	SIG-4-W3
		2.20	1.10	.44	.04	
5	5	69	28	11,2	1	SIG-5-W3
		2.72	1.10	.44	.04	
6	6	85	28	11,2	1	SIG-6-W3
		3.35	1.10	.44	.04	
7	7	117	28	11,2	1	SIG-7-W3
		4.61	1.10	.44	.04	
8	8	143	28	11,2	1	SIG-8-W3
		5.63	1.10	.44	.04	

**Ordering Codes**

**Safety Locking Plate**      **\*SIG-\*1-\*W3**

\* Safety Locking Plate      **SIG**

\* STAUFF Group      **1**

\* Material code      Carbon Steel, zinc/nickel-plated      **W3**

   Stainless Steel V2A      **W4**

   1.4301 / 1.4305 (AISI 304 / 303)

   Stainless Steel V4A      **W5**

   1.4401 / 1.4571 (AISI 316 / 316 Ti)

Alternative materials and surface finishings are available upon request. Contact STAUFF for further information.

**Stacking Bolt**  
(for Use with Safety Locking Plate SIG)  
**Type AF**

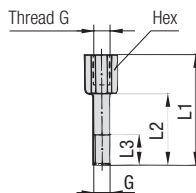

Group STAUFF	DIN	Dimensions (mm/in)					Ordering Codes (Standard Options)
		Thread G	L1	L2	L3 min.	Hex	
1	0	M6	34	20	12	11	AF-1-M-W3
		1/4-20 UNC	1.34	.79	.47	.43	AF-1-U-W3
1A	1	M6	34	20	12	11	AF-1A-M-W3
		1/4-20 UNC	1.34	.79	.47	.43	AF-1A-U-W3
2	2	M6	40	25	12	11	AF-2-M-W3
		1/4-20 UNC	1.57	.98	.47	.43	AF-2-U-W3
3	3	M6	44	30	12	11	AF-3-M-W3
		1/4-20 UNC	1.73	1.18	.47	.43	AF-3-U-W3
4	4	M6	49	35	12	11	AF-4-M-W3
		1/4-20 UNC	1.93	1.38	.47	.43	AF-4-U-W3
5	5	M6	64	50	12	11	AF-5-M-W3
		1/4-20 UNC	2.52	1.97	.47	.43	AF-5-U-W3
6	6	M6	74	60	12	11	AF-6-M-W3
		1/4-20 UNC	2.91	2.36	.47	.43	AF-6-U-W3
7	7	M6	99	85	12	11	AF-7-M-W3
		1/4-20 UNC	3.90	3.35	.47	.43	AF-7-U-W3
8	8	M6	124	110	12	11	AF-8-M-W3
		1/4-20 UNC	4.88	4.33	.47	.43	AF-8-U-W3

**Ordering Codes**

**Stacking Bolt**      **\*AF-\*1-\*M-\*W3**

\* Type of bolt      Stacking Bolt      **AF**

   (according to STAUFF Standard)

\* STAUFF Group      **1**

\* Thread code      Metric ISO thread      **M**

   Unified coarse (UNC) thread      **U**

\* Material code      Carbon Steel, zinc/nickel-plated      **W3**

   Stainless Steel V2A      **W4**

   1.4301 / 1.4305 (AISI 304 / 303)

   Stainless Steel V4A      **W5**

   1.4401 / 1.4571 (AISI 316 / 316 Ti)

All threaded parts are available with Metric ISO thread or unified coarse (UNC) thread according to dimension table. Alternative materials and surface finishings are available upon request. Contact STAUFF for further information.



A



### ① Type of Installation

Please select the type of installation (e.g. Weld Plates, Rail Nuts etc.) and add the corresponding Code to position ① of the order code for your clamp assembly.

Without Installation Equipment  
Code: **none**

#### Installation on Weld Plate

Single Weld Plate  
Code: **SP**

Elongated Weld Plate  
Code: **SPV**

Twin Weld Plate (for STAUFF Group 1 to 6 only)  
Code: **DSP**

Group Weld Plate (for STAUFF Group 1 to 6 only)  
Code: **RAP**

Angled Weld Plate (for STAUFF Group 1 to 6 only)  
Code: **WSP**

Bridge Weld Plate (for STAUFF Group 1A to 6 only)  
Code: **BSP**

#### Installation on Mounting / Channel Rail

Hexagon Rail Nut  
Code: **SM** (Carbon Steel)  
Code: **SMG** (Stainless Steel)

Channel Rail Adaptor  
Code: **CRA**

### ② Group Size & Diameter

Please select the required group size and diameter and add the corresponding Code to position ② of the order code for your clamp assembly.

Group	Outside Diameter	Availability of Clamp Body Materials & Designs			Code	
		STAUFF (DIN)	P / T / H (mm)	Profiled Design		Type H
1 (0)	6		●	●	○	106
	6,4		●	●	○	106.4
	8		●	●	○	108
	9,5		●	●	○	109.5
	10		●	●	○	110
1A (1)	12		●	●	○	112
	6		●	●	○	106A
	6,4		●	●	○	106.4A
	8		●	●	○	108A
	9,5		●	●	○	109.5A
2 (2)	10		●	●	○	110A
	12		●	●	○	112A
	12,7		●	●	○	212.7
	13,5		●	●	○	213.5
	14		●	●	○	214
	15		●	●	○	215
	16		●	●	○	216
3 (3)	17,2		●	●	○	217.2
	18		●	●	○	218
	19		●	●	○	319
	20		●	●	○	320
	21,3		●	●	○	321.3
4 (4)	22		●	●	○	322
	25		●	●	○	325
	25,4		●	●	○	325.4
	6		○	○	●	406
	8		○	○	●	408
	10		○	○	●	410
	12		○	○	●	412
	12,7		○	○	●	412.7
	14		○	○	●	414
	15		○	○	●	415
	16		○	○	●	416
	17,2		○	○	●	417.2
	18		○	○	●	418
	19		○	○	●	419
	26,9		●	●	○	426.9
28		●	●	○	428	
28,6		●	○	○	428.6	
30		●	●	○	430	
32		●	●	○	432	

Group	Outside Diameter	Availability of Clamp Body Materials & Designs			Code	
		STAUFF (DIN)	P / T / H (mm)	Profiled Design		Type H
5 (5)	32		●	●	○	532
	33,7		●	●	○	533.7
	35		●	●	○	535
	38		●	●	○	538
	40		●	●	○	540
	41,3		●	○	○	541.3
	42		●	●	○	542
	20		○	○	●	620
	21,3		○	○	●	621.3
	22		○	○	●	622
6 (6)	25		○	○	●	625
	26,9		○	○	●	626.9
	28		○	○	●	628
	30		○	○	●	630
	32		○	○	●	632
	44,5		●	●	○	644.5
	48,3		●	●	○	648.3
	50,8		●	●	○	650.8
	54		●	●	○	654
	57,2		●	●	○	757.2
7 (7)	60,3		●	●	○	760.3
	63,5		●	●	○	763.5
	70		●	●	○	770
	73		●	●	○	773
	76,1		●	●	○	776.1
8 (8)	88,9		●	●	○	888.9
	102		●	●	○	8102L

● Standard Option



Please see pages 32 and 33 with detailed order examples for some of the most popular Standard Series clamp assemblies.

### ③ Clamp Body Design & Material

Please select the design and material of your clamp body and add the corresponding **Code** to position ③ of the order code for your clamp assembly.

Please check the availability of the selected clamp body design and material according to the matrix table in ②.

#### Profiled Design



Polypropylene  
Code: **PP**



Polypropylene (Colour: Black)  
Code: **PP-BK**



Polyamide  
Code: **PA**



Thermoplastic Elastomer (87 Shore-A)  
Code: **SA**



Aluminium  
Code: **AL** (for STAUFF Group 1A to 6 only)

#### Type H (Smooth)



Polypropylene  
Code: **PP-H**



Polypropylene (Colour: Black)  
Code: **PP-H-BK**



Polyamide  
Code: **PA-H**



Thermoplastic Elastomer (87 Shore-A)  
Code: **SA-H**

#### Type RI (with Elastomer Insert)



Polypropylene  
Code: **PP-R** (for STAUFF Group 4 and 6 only)



Polyamide  
Code: **PA-R** (for STAUFF Group 4 and 6 only)

See pages 154 / 155 for material properties and technical information.

Please contact STAUFF for further details on fire-proof clamp body materials, tested and approved according to several international fire-protection standards.

### ④ Mounting & Fitting Combination

Please select the mounting and fitting combination (e.g. bolts, screws, cover plates etc.) and add the corresponding **Code** to position ④ of the order code for your clamp assembly.

#### Installation with Cover Plate and Bolts

Cover Plate DP with  
Hexagon Head Bolts AS  
Code: **DP-AS**

Cover Plate DP with  
Socket Cap Screws IS\*  
Code: **DP-IS**

#### Installation with Locking Plate and Bolts

Safety Locking Plate SIG with  
Stacking Bolts AF  
Code: **SIG-AF**

#### Installation with Inserts and Bolts

Inserts EP (Plastic) with  
Hexagon Head Bolts AS  
Code: **EP-AS**

Inserts ES (Steel) with  
Hexagon Head Bolts AS  
Code: **ES-AS**

#### Installation with Bolts only

Socket Cap Screws IS (Washers US included)  
Code: **IS**

Slotted Head Screws LI (Washers US included)  
Code: **LI** (for STAUFF Group 1 to 6 only)

\* Special lengths of Socket Cap Screws IS required. For exact lengths, please see details of Hexagon Head Bolt, type AS (for use with Cover Plates DP) on page 26.

### ⑤ Thread Type

Please select the required thread type and add the corresponding **Code** to position ⑤ of the order code for your clamp assembly.

Metric ISO thread  
Code: **M**

Unified coarse (UNC) thread  
Code: **U**

All threaded parts are available with Metric ISO thread or unified coarse (UNC) thread according to dimension table.

### ⑥ Material & Surface Finishing

Please select the required material & surface finishing of the metal parts and add the corresponding **Code** to position ⑥ of the order code for your clamp assembly.

Metal parts made of Carbon Steel, zinc/nickel-plated **W3**

Metal parts made of Stainless Steel V2A  
1.4301 / 1.4305 (AISI 304 / 303) **W4**

Metal parts made of Stainless Steel V4A  
1.4401 / 1.4571 (AISI 316 / 316 Ti) **W5**

Weld Plate made of Carbon Steel, phosphated; Other metal parts made of Carbon Steel, zinc/nickel-plated **W10**

Individual combinations of alternative materials and surface finishings are available upon request. Contact STAUFF for further information.

### ⑦ Assembling & Kitting

If required, please select an additional assembling and kitting option and add the corresponding **Code** to the last position of the order code for your clamp assembly.

**Components supplied separately**  
Code: **none** (standard option)

**Components assembled**  
Code: **A** (special option)

**Components packed in kits**  
Code: **K** (special option)



A



- 2x **Hexagon Head Bolt**  
Surface: W3  
Thread: Metric
- 1x **Cover Plate**  
Surface: W3
- 1x **Clamp Body** (two halves)  
STAUFF Group 2 (DIN 2)  
O.D. 12,7 mm / .50 in  
Material: Polypropylene  
Profiled inside surface  
with tension clearance
- 1x **Single Weld Plate**  
Surface: W2  
Thread: Metric

**Order Code**

**SP-212.7-PP-DP-AS-M-W10**

W10 is the standard option for this type of installation.



- 2x **Socket Cap Screw**  
with Washer  
Surface: W3  
Thread: Metric
- 1x **Clamp Body** (two halves)  
STAUFF Group 2 (DIN 2)  
O.D. 12,7 mm / .50 in  
Material: Polypropylene  
Profiled inside surface  
with tension clearance
- 1x **Single Weld Plate**  
Surface: W2  
Thread: Metric

**Order Code**

**SP-212.7-PP-IS-M-W10**

W10 is the standard option for this type of installation.



- 2x **Slotted Head Screw**  
with Washer  
Surface: W3  
Thread: Metric
- 1x **Clamp Body** (two halves)  
STAUFF Group 2 (DIN 2)  
O.D. 12,7 mm / .50 in  
Material: Polypropylene  
Profiled inside surface  
with tension clearance
- 1x **Single Weld Plate**  
Surface: W2  
Thread: Metric

**Order Code**

**SP-212.7-PP-LI-M-W10**

W10 is the standard option for this type of installation.  
Available up to STAUFF Group 6 (DIN Group 6) only.



- 2x **Hexagon Head Bolt**  
Surface: W3  
Thread: Metric
- 1x **Cover Plate**  
Surface: W3
- 1x **Clamp Body** (two halves)  
STAUFF Group 2 (DIN 2)  
O.D. 12,7 mm / .50 in  
Material: Polypropylene  
Profiled inside surface  
with tension clearance
- 1x **Elongated Weld Plate**  
Surface: W2  
Thread: Metric

**Order Code**

**SPV-212.7-PP-DP-AS-M-W10**

W10 is the standard option for this type of installation.



- 2x **Socket Cap Screw**  
with Washer  
Surface: W3  
Thread: Metric
- 1x **Clamp Body** (two halves)  
STAUFF Group 2 (DIN 2)  
O.D. 12,7 mm / .50 in  
Material: Polypropylene  
Profiled inside surface  
with tension clearance
- 1x **Elongated Weld Plate**  
Surface: W2  
Thread: Metric

**Order Code**

**SPV-212.7-PP-IS-M-W10**

W10 is the standard option for this type of installation.



- 2x **Slotted Head Screw**  
with Washer  
Surface: W3  
Thread: Metric
- 1x **Clamp Body** (two halves)  
STAUFF Group 2 (DIN 2)  
O.D. 12,7 mm / .50 in  
Material: Polypropylene  
Profiled inside surface  
with tension clearance
- 1x **Elongated Weld Plate**  
Surface: W2  
Thread: Metric

**Order Code**

**SPV-212.7-PP-LI-M-W10**

W10 is the standard option for this type of installation.  
Available up to STAUFF Group 6 (DIN Group 6) only.



- 2x **Hexagon Head Bolt**  
Surface: W3  
Thread: Metric
- 1x **Cover Plate**  
Surface: W3
- 1x **Clamp Body** (two halves)  
STAUFF Group 2 (DIN 2)  
O.D. 12,7 mm / .50 in  
Material: Polypropylene  
Profiled inside surface  
with tension clearance
- 2x **Hexagon Rail Nut**  
Surface: W3  
Thread: Metric

**Order Code** (Mounting Rail TS not included.)

**SM-212.7-PP-DP-AS-M-W3**

W3 is the standard option for this type of installation.



- 2x **Socket Cap Screw**  
with Washer  
Surface: W3  
Thread: Metric
- 1x **Clamp Body** (two halves)  
STAUFF Group 2 (DIN 2)  
O.D. 12,7 mm / .50 in  
Material: Polypropylene  
Profiled inside surface  
with tension clearance
- 2x **Hexagon Rail Nut**  
Surface: W3  
Thread: Metric

**Order Code** (Mounting Rail TS not included.)

**SM-212.7-PP-IS-M-W3**

W3 is the standard option for this type of installation.



- 2x **Slotted Head Screw**  
with Washer  
Surface: W3  
Thread: Metric
- 1x **Clamp Body** (two halves)  
STAUFF Group 2 (DIN 2)  
O.D. 12,7 mm / .50 in  
Material: Polypropylene  
Profiled inside surface  
with tension clearance
- 2x **Hexagon Rail Nut**  
Surface: W3  
Thread: Metric

**Order Code** (Mounting Rail TS not included.)

**SM-212.7-PP-LI-M-W3**

W3 is the standard option for this type of installation.  
Available up to STAUFF Group 6 (DIN Group 6) only.





- 2x **Hexagon Head Bolt**  
Surface: W3  
Thread: Metric
- 1x **Cover Plate**  
Surface: W3
- 1x **Clamp Body** (two halves)  
STAUFF Group 2 (DIN 2)  
O.D. 12,7 mm / .50 in  
Material: Polypropylene  
Profiled inside surface  
with tension clearance

**Order Code**
**212.7-PP-DP-AS-M-W3**
**W3** is the standard option for this type of installation.

- 2x **Socket Cap Screw**  
with Washer  
Surface: W3  
Thread: Metric
- 1x **Clamp Body** (two halves)  
STAUFF Group 2 (DIN 2)  
O.D. 12,7 mm / .50 in  
Material: Polypropylene  
Profiled inside surface  
with tension clearance

**Order Code**
**212.7-PP-IS-M-W3**
**W3** is the standard option for this type of installation.

- 2x **Slotted Head Screw**  
with Washer  
Surface: W3  
Thread: Metric
- 1x **Clamp Body** (two halves)  
STAUFF Group 2 (DIN 2)  
Tube-O.D. 12,7 mm / .50 in  
Material: Polypropylene  
Profiled inside surface  
with tension clearance

**Order Code**
**212.7-PP-LI-M-W3**
**W3** is the standard option for this type of installation.

- 2x **Stacking Bolt**  
Surface: W3  
Thread: Metric
- 1x **Safety Locking Plate**  
Surface: W3
- 1x **Clamp Body** (two halves)  
STAUFF Group 2 (DIN 2)  
O.D. 12,7 mm / .50 in  
Material: Polypropylene  
Profiled inside surface  
with tension clearance

**Order Code**
**212.7-PP-SIG-AF-M-W3**
**W3** is the standard option for this type of installation.

- 1x **Socket Cap Screw**  
with Washer  
Surface: W3  
Thread: Metric
- 1x **Clamp Body** (two halves)  
STAUFF Group 1 (DIN 0)  
O.D. 6 mm / .24 in  
Material: Polypropylene  
Profiled inside surface  
with tension clearance  
Thread: Metric

**Order Code\***
**SP-106-PP-IS-M-W10**
**W10** is the standard option for this type of installation.

- 1x **Single Weld Plate**  
Surface: W2  
Thread: Metric

**Thread codes**

All threaded parts are available with Metric ISO thread or unified coarse (UNC) thread according to dimension table.

Metric ISO thread	<b>M</b>
Unified coarse (UNC) thread	<b>U</b>

**Material codes**

The below listed material codes describe the materials and surface finishings of metal parts that are most relevant for Standard Series clamp assemblies. Individual combinations of alternative materials and surface finishings are available upon request. Contact STAUFF for further information.

Metal parts made of Carbon Steel, zinc/nickel-plated	<b>W3</b>
Metal parts made of Stainless Steel V2A 1.4301 / 1.4305 (AISI 304 / 303)	<b>W4</b>
Metal parts made of Stainless Steel V4A 1.4401 / 1.4571 (AISI 316 / 316 Ti)	<b>W5</b>
Weld Plate made of Carbon Steel, phosphated; Other metal parts made of Carbon Steel, zinc/nickel-plated	<b>W10</b>

**Technical Notes**

\* Because of their design, STAUFF Group 1 (DIN Group 0) clamp assemblies only include one single bolt / screw.



- 2x **Hexagon Head Bolt**  
Surface: W3  
Thread: Metric
- 2x **Insert**  
Material: Plastic
- 1x **Clamp Body** (two halves)  
STAUFF Group 2 (DIN 2)  
O.D. 12,7 mm / .50 in  
Material: Polypropylene  
Profiled inside surface  
with tension clearance
- 1x **Single Weld Plate**  
Surface: W2  
Thread: Metric

**Order Code**
**SP-212.7-PP-EP-AS-M-W10**
**W10** is the standard option for this type of installation.

- 2x **Hexagon Head Bolt**  
Surface: W3  
Thread: Metric
- 2x **Insert**  
Material: Plastic
- 1x **Clamp Body** (two halves)  
STAUFF Group 2 (DIN 2)  
O.D. 12,7 mm / .50 in  
Material: Polypropylene  
Profiled inside surface  
with tension clearance
- 1x **Elongated Weld Plate**  
Surface: W2  
Thread: Metric

**Order Code**
**SPV-212.7-PP-EP-AS-M-W10**
**W10** is the standard option for this type of installation.





**Clamp Body**  
Profiled Inside Surface with Tension Clearance

36



**Clamp Body**  
Smooth Inside Surface without Tension Clearance

38



**Clamp Body with Elastomer Insert**

39



**Weld Plate for Single Clamps**  
SPAL

40



**Weld Plate for Double Clamps**  
SPAS

40



**Elongated Weld Plate for Single Clamps**  
SPAL-DUEB

41



**Elongated Weld Plate for Double Clamps**  
SPAS-DUEB

41



**Mounting Rail Nut**  
GMV

42



**Mounting Rail**  
STSV

42



**Channel Rail Adaptor**  
CRA

43



**Cover Plate for Single Clamps**  
DPAL

44



**Cover Plate for Double Clamps**  
DPAL

44



**Hexagon Head Bolt**  
AS

45



**Socket Cap Screw**  
IS

45



**Safety Washer (DIN 93)**  
SI

46



**Safety Washer (DIN 463)**  
SI

46



**Safety Locking Plate**  
SIP

47



**Stacking Bolt**  
AF

47

**Clamp Assemblies**

48



## Clamp Body - Profiled Design

Profiled Inside Surface with Tension Clearance

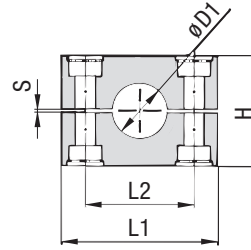
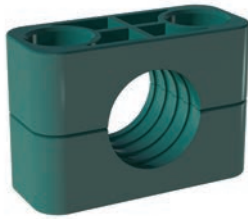

B

### Ordering Codes

#### Clamp Body

**\*3\*006-\*PP**

One clamp body is consisting of two clamp halves.

- \* 1<sup>st</sup> part of STAUFF Group **3**
- \* Exact outside diameter Ø D1 (mm) **006**
- \* Material code (see below) **PP**

### Standard Materials



**Polypropylene**  
Colour: Green  
Material code: **PP**



**Polypropylene**  
Colour: Black  
Material code: **PP-BK**



**Polyamide**  
Colour: Black  
Material code: **PA**



**Thermoplastic Elastomer (87 Shore-A)**  
Colour: Black  
Material code: **SA**



**Aluminium**  
Colour: Self-Colour  
Material code: **AL**

See pages 154 / 155 for material properties and technical information.

### Special Materials

Please contact STAUFF for further details on fire-proof clamp body materials, tested and approved according to several international fire-protection standards (such as BS 6853, EN 45545-2, UL 94 and many more).

See pages 156 / 157 for material properties and technical information.

### Product Features

- Proven, tested and trusted product in various markets
- Recommended for the safe installation of rigid pipes and tubes
- Available for all commonly used pipe and tube outside diameters
- Environmental protection due to vibration/noise reducing design
- Excellent weathering resistance, even under extreme conditions

Group	STAUFF	DIN	Outside Diameter		Nominal Bore		Ordering Codes (2 Clamp Halves) (** = Material)	Dimensions (mm/in)					
			Pipe / Tube Ø D1 (mm)	(in)	Pipe (in)	Copper Tube ASTM B88 (in)		L1 PP/PA/SA	L1 AL	L2	H	S min.	Width
3S	1	6					3006-**-**	55	56	33	32	0,6	30,5
		6,4	1/4			3006.4-**-**							
		8	5/16			3008-**-**							
		9,5	3/8	1/4		3009.5-**-**							
		10		1/8		3010-**-**							
		12				3012-**-**							
		12,7	1/2	3/8		3012.7-**-**							
		13,5		1/4		3013.5-**-**							
		14				3014-**-**							
		15				3015-**-**							
		16	5/8	1/2		3016-**-**							
		17,2		3/8		3017.2-**-**							
		18				3018-**-**							
		20				3020-**-**							
4S	2	19	3/4			4019-**-**	70	70	45	48	0,6	30,5	
		20				4020-**-**							
		21,3		1/2		4021.3-**-**							
		22	7/8	3/4		4022-**-**							
		25				4025-**-**							
		25,4	1			4025.4-**-**							
		26,9		3/4		4026.9-**-**							
		28				4028-**-**							
		30				4030-**-**							
		30				5030-**-**							
5S	3	32	1-1/4			5032-**-**	85	85	60	60	0,6	30,5	
		33,7		1		5033.7-**-**							
		35		1-1/4		5035-**-**							
		38	1-1/2			5038-**-**							
		40				5040-**-**							
		41,3		1-1/2		5041.3-**-**							
		42		1-1/4		5042-**-**							
		42	1-1/2	1-1/4		6038-**-**							
6S	4	44,5	1-3/4			6044.5-**-**	115	120	90	89	2	45	
		48,3		1-1/2		6048.3-**-**							
		50,8	2			6050.8-**-**							
		54		2		6054-**-**							
		55				6055-**-**							
		57				6057-**-**							
		57,2	2-1/4			6057.2-**-**							
		60,3		2		6060.3-**-**							
		63,5	2-1/2			6063.5-**-**							
		65				6065-**-**							
70	2-3/4			6070-**-**									

See page 37 for STAUFF Group 7S to 12S (DIN Group 5 to 10).

Additional outside diameters are available upon request. Please contact STAUFF for further information.

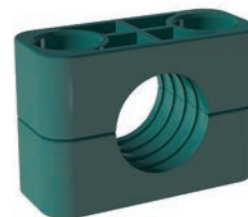
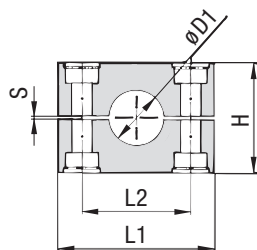

**Clamp Body - Profiled Design**
**Profiled Inside Surface with Tension Clearance**

**B**

Group	STAUFF	DIN	Outside Diameter		Nominal Bore	Ordering Codes (2 Clamp Halves) (** = Material)	Dimensions (mm/in)				
			Pipe / Tube Ø D1 (mm)	(in)			Pipe (in)	L1 PP/PA	L1 AL	L2	H
7S	5	60,3			7060.3-***	154	152	122	120	2	60
		65			7065-***						
		70	2-3/4		7070-***						
		73		2-1/2 (ANSI B 36-10)	7073-***						
		75			7075-***						
		76,1	3	2-1/2 (DIN EN 10220)	7076.1-***						
		80			7080-***						
		82,5			7082.5-***						
		88,9	3-1/2	3	7088.9-***						
8S	6	88,9	3-1/2	3	8088.9-***	206	208	168	168	2	80
		100			8100-***						
		102	4	3-1/2	8102-***						
		108			8108-***						
		114	4-1/2	4	8114-***						
		127	5		8127-***						
		133			8133-***						
9S	7	127	5		9127-***	251	255	205	200	3	91
		133			9133-***						
		140		5	9140-***						
		152	6		9152-***						
		159			9159-***						
		165			9165-***						
10S	8	168		6	9168-***	336	326	265	270	3	120
		177,8			10177.8-***						
		193,7			10193.7-***						
		203	8		10203-***						
		216			10216-***						
11S	9	219		8	10219-***	470	470	395	410	8	162
		273		10	11273-***						
		324		12	11324-***						
12S	10	356		14	12356-***	630	630	534	530	20	182
		406		16	12406-***						

**Ordering Codes**
**Clamp Body**
**\*7\*060.3-\*PP**

One clamp body is consisting of two clamp halves.

- \* 1<sup>st</sup> part of STAUFF Group
- \* Exact outside diameter Ø D1 (mm)
- \* Material code (see below)

**7  
060.3  
PP**
**Standard Materials**

**Polypropylene**  
 Colour: Green  
 Material code: **PP**

**Polypropylene**  
 Colour: Black  
 Material code: **PP-BK**

**Polyamide**  
 Colour: Black  
 Material code: **PA**

**Aluminium**  
 Colour: Self-Colour  
 Material code: **AL**

See pages 154 / 155 for material properties and technical information.

**Special Materials**
**Please contact STAUFF for further details on fire-proof clamp body materials, tested and approved according to several international fire-protection standards (such as BS 6853, EN 45545-2, UL 94 and many more).**

See page 36 for STAUFF Group 3S to 6S (DIN Group 1 to 4).

Additional outside diameters are available upon request. Please contact STAUFF for further information.

See pages 156 / 157 for material properties and technical information.

**Product Features**

- Proven, tested and trusted product in various markets
- Recommended for the safe installation of rigid pipes and tubes
- Available for all commonly used pipe and tube outside diameters
- Environmental protection due to vibration/noise reducing design
- Excellent weathering resistance, even under extreme conditions



## Clamp Body - Type H

Smooth Inside Surface without Tension Clearance

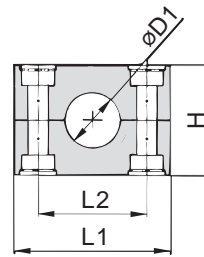
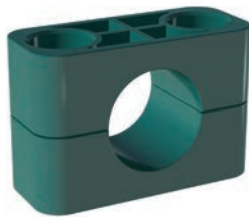

B

### Ordering Codes

#### Clamp Body

**\*3\*006-\*PP-H**

One clamp body is consisting of two clamp halves.

- \* 1<sup>st</sup> part of STAUFF Group **3**
- \* Exact outside diameter Ø D1 (mm) **006**
- \* Material code (see below) **PP-H**

### Standard Materials



**Polypropylene**  
Colour: Green  
Material code: **PP-H**



**Polypropylene**  
Colour: Green  
Material code: **PP-H-BK**



**Polyamide**  
Colour: Black  
Material code: **PA-H**



**Thermoplastic Elastomer (87 Shore-A)**  
Colour: Black  
Material code: **SA-H**

See pages 154 / 155 for material properties and technical information.

### Special Materials

Please contact STAUFF for further details on fire-proof clamp body materials, tested and approved according to several international fire-protection standards (such as BS 6853, EN 45545-2, UL 94 and many more).

See pages 156 / 157 for material properties and technical information.

### Product Features

- Proven, tested and trusted product in various markets
- Recommended for the safe installation of hoses and cables
- Chamfered edges avoid damaging of the hose or cable
- Available for all commonly used hose and cable outside diameters
- Excellent weathering resistance, even under extreme conditions

Group	STAUFF	DIN	Outside Diameter		Ordering Codes (2 Clamp Halves) (*-*H = Material)	Dimensions ( <sup>mm</sup> / <sub>in</sub> )			
			Hose Ø D1 (mm)	(in)		L1	L2	H	Width
3S	1	6			3006-**-H	55 2.16	33 1.30	30,5 1.20	30,5 1.20
		6,4	1/4	3006.4-**-H					
		8	5/16	3008-**-H					
		9,5	3/8	3009.5-**-H					
		10		3010-**-H					
		12		3012-**-H					
		12,7	1/2	3012.7-**-H					
		13,5		3013.5-**-H					
		14		3014-**-H					
		15		3015-**-H					
		16	5/8	3016-**-H					
		17,2		3017.2-**-H					
		4S	2	18					
19	3/4			4019-**-H					
20				4020-**-H					
21,3				4021.3-**-H					
22	7/8			4022-**-H					
25				4025-**-H					
25,4	1			4025.4-**-H					
26,9				4026.9-**-H					
5S	3	28		4028-**-H	85 3.35	60 2.36	58 2.28	30,5 1.20	
		30		4030-**-H					
		30		5030-**-H					
		32	1-1/4	5032-**-H					
		33,7		5033.7-**-H					
		35		5035-**-H					
		38	1-1/2	5038-**-H					
6S	4	40		5040-**-H	115 4.53	90 3.54	87 3.43	45 1.77	
		41,3		5041.3-**-H					
		42		5042-**-H					
		38	1-1/2	6038-**-H					
		42		6042-**-H					
		44,5	1-3/4	6044.5-**-H					
		48,3		6048.3-**-H					
		50,8	2	6050.8-**-H					
		55		6055-**-H					
		57		6057-**-H					
57,2	2-1/4	6057.2-**-H							
60,3		6060.3-**-H							
63,5	2-1/2	6063.5-**-H							
65		6065-**-H							
70	2-3/4	6070-**-H							

Additional outside diameters are available upon request. Please contact STAUFF for further information.

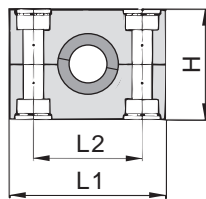
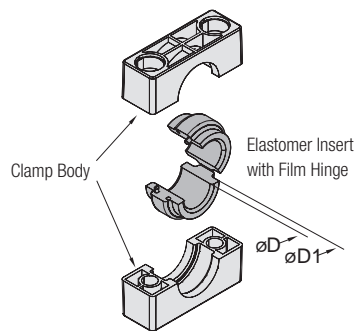

**Clamp Body with Elastomer Insert  
Type RI**

**B**

Group	STAUFF	DIN	Outside Diameter		Ordering Codes Clamp Assembly (Clamp Body + Insert)	***R = Clamp Body Material Clamp Body (2 Clamp Halves)	Insert *	Dimensions (mm/in)													
			Ø D (mm)	(in)				Ø D1	L1	L2	H	Width									
4S	2	2	6		4006-***-R	4S-***-R	RI-06-4/4S	25	70	45	46,5	30,5									
			8	5/16	4008-***-R		RI-08-4/4S														
			10		4010-***-R		RI-10-4/4S														
			12		4012-***-R		RI-12-4/4S														
			12,7	1/2	4012.7-***-R		RI-12.7-4/4S														
			14		4014-***-R		RI-14-4/4S														
			15		4015-***-R		RI-15-4/4S														
			16	5/8	4016-***-R		RI-16-4/4S														
			17,2		4017.2-***-R		RI-17.2-4/4S														
			18		4018-***-R		RI-18-4/4S														
19	3/4	4019-***-R	RI-19-4/4S																		
5S	3	3	20		5020-***-R	5S-***-R	RI-20-6/5S	38	85	60	58	30,5									
			21,3		5021.3-***-R		RI-21.3-6/5S														
			22	7/8	5022-***-R		RI-22-6/5S														
			25		5025-***-R		RI-25-6/5S														
			26,9		5026.9-***-R		RI-26.9-6/5S														
			28		5028-***-R		RI-28-6/5S														
			30		5030-***-R		RI-30-6/5S														
			32	1-1/4	5032-***-R		RI-32-6/5S														
			32	1-1/4	6032-***-R		RI-32-6S														
			33,7		6033.7-***-R		RI-33.7-6S														
35		6035-***-R	RI-35-6S																		
38,7		6038.7-***-R	RI-38.7-6S																		
40		6040-***-R	RI-40-6S																		
42		6042-***-R	RI-42-6S																		
45,5		6045.5-***-R	RI-45.5-6S																		
48		6048-***-R	RI-48-6S																		
51	2	6051-***-R	RI-51-6S																		
53,4		6053.4-***-R	RI-53.4-6S																		
56,4		6056.4-***-R	RI-56.4-6S																		
7S	5	5	55		7055-***-R	7S-***-R	RI-55-7S	88	154	122	120	60									
			57	2-1/4	7057-***-R		RI-57-7S														
			60		7060-***-R		RI-60-7S														
			63,5	2-1/2	7063.5-***-R		RI-63.5-7S														
			65		7065-***-R		RI-65-7S														
			70	2-3/4	7070-***-R		RI-70-7S														
			72		7072-***-R		RI-72-7S														
			76	3	7076-***-R		RI-76-7S														
			8S	6	6		80							8080-***-R	8S-***-R	RI-80-8S	114	208	168	168	80
							88,9						3-1/2	8088.9-***-R		RI-88.9-8S					
102		8102-***-R				RI-102-8S															
114		9114-***-R				RI-114-9S															
9S	7	7	133	5-1/4	9133-***-R	9S-***-R	RI-133-9S	150	251	205	200	91									
			140		9140-***-R		RI-140-9S														
			150		10150-***-R		RI-150-10S														
10S	8	8	165		10165-***-R	10S-***-R	RI-165-10S	200	336	265	270	120									
			168		10168-***-R		RI-168-10S														
			172		10172-***-R		RI-172-10S														

\* Elastomer Inserts for Heavy Series clamp bodies, STAUFF Group 4S also fit into Standard Series clamp bodies, STAUFF Group 4.  
Elastomer Inserts for Heavy Series clamp bodies, STAUFF Group 5S also fit into Standard Series clamp bodies, STAUFF Group 6.

Additional outside diameters are available upon request. Please contact STAUFF for further information.

**Ordering Codes**

**Clamp Assembly** \*4\*006-\*PP-R

One assembly is consisting of one clamp body and one insert.

- \* 1<sup>st</sup> part of STAUFF Group **4**
- \* Exact outside diameter Ø D (mm) **006**
- \* Material code (see below) **PP-R**

**Clamp Body** \*4S-\*PP-R

One clamp body is consisting of two clamp halves.

- \* STAUFF Group **4S**
- \* Material code (see below) **PP-R**

**Elastomer Insert** \*RI-\*06-\*4/4S

- \* Elastomer Insert **RI**
- \* Exact outside diameter Ø D (mm) **06**
- \* STAUFF Group 4S (Heavy) and 4 (Standard) **4/4S**
- 5S (Heavy) and 6 (Standard) **6/5S**
- 6S (Heavy) **6S**
- 7S (Heavy) **7S**
- 8S (Heavy) **8S**
- 9S (Heavy) **9S**
- 10S (Heavy) **10S**

**Standard Materials**

**Polypropylene**  
Colour: Black  
Material code: **PP-R**

**Polyamide**  
Colour: Black  
Material code: **PA-R**

**Elastomer Insert**  
4S to 6S: **Thermoplastic Elastomer** (73 Shore-A)  
7S to 10S: **EPDM** (70 Shore-A)  
Colour: Black

See pages 154 / 155 for material properties and technical information.

**Special Materials**

Please contact STAUFF for further details on fire-proof clamp body materials, tested and approved according to several international fire-protection standards (such as BS 6853, EN 45545-2, UL 94 and many more).

See pages 156 / 157 for material properties and technical information.

**Product Features**

- Proven, tested and trusted product in various markets
- Either for the extra vibration/noise reducing installation of pipes and tubes or the extra gentle installation of hoses and cables
- Available for all commonly used outside diameters
- Excellent weathering resistance, even under extreme conditions



**Weld Plate for Single Clamps**  
Type SPAL

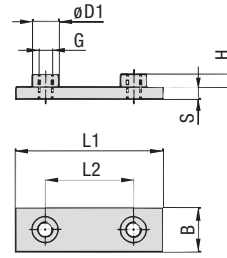
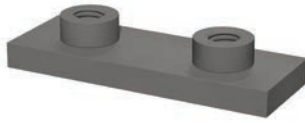

B

**Ordering Codes**

**Weld Plate \*SPAL-\*3S-\*M-\*W2**

- \* Weld Plate for Single Clamps **SPAL**
- \* STAUFF Group **3S**
- \* Thread code Metric ISO thread **M**  
Unified coarse (UNC) thread **U**
- \* Material code Carbon Steel, uncoated **W1**  
Carbon Steel, phosphated **W2**  
Carbon Steel, zinc/nickel-plated **W3**  
Stainless Steel V2A **W4**  
1.4301 / 1.4305 (AISI 304 / 303) **W4**  
Stainless Steel V4A **W5**  
1.4401 / 1.4571 (AISI 316 / 316 Ti) **W5**

Group	STAUFF	DIN	Dimensions (mm/m)					Thread G	ØD1	Ordering Codes (Standard Options)
			L1	L2	B	S	H			
3S	1		74	33	30	8	8	M10	18	SPAL-3S-M-W2
			2.91	1.30	1.18	.31	.31	3/8-16 UNC	.71	SPAL-3S-U-W2
4S	2		86	45	30	8	8	M10	18	SPAL-4S-M-W2
			3.39	1.77	1.18	.31	.31	3/8-16 UNC	.71	SPAL-4S-U-W2
5S	3		100	60	30	8	8	M10	18	SPAL-5S-M-W2
			3.94	2.36	1.18	.31	.31	3/8-16 UNC	.71	SPAL-5S-U-W2
6S	4		140	90	45	10	8	M12	20	SPAL-6S-M-W2
			5.51	3.54	1.77	.39	.31	7/16-14 UNC	.78	SPAL-6S-U-W2
7S	5		180	122	60	10	12	M16	24	SPAL-7S-M-W2
			7.09	4.80	2.36	.39	.47	5/8-11 UNC	.94	SPAL-7S-U-W2
8S	6		226	168	80	15	18	M20	30	SPAL-8S-M-W1
			8.90	6.61	3.15	.59	.71	3/4-10 UNC	1.18	SPAL-8S-U-W1
9S	7		270	205	90	15	21	M24	35	SPAL-9S-M-W1
			10.63	8.07	3.54	.59	.83	7/8-9 UNC	1.38	SPAL-9S-U-W1
10S	8		340	265	120	25	21	M30	45	SPAL-10S-M-W1
			13.39	10.43	4.72	.98	.83	1-1/8-7 UNC	1.77	SPAL-10S-U-W1
11S	9		520	395	160	30	38	M30	50	SPAL-11S-M-W1
			20.47	15.55	6.30	1.18	1.50	1-1/4-7 UNC	1.97	SPAL-11S-U-W1
12S	10		680	534	180	30	38	M30	50	SPAL-12S-M-W1
			27.16	21.02	7.09	1.18	1.50	1-1/4-7 UNC	1.97	SPAL-12S-U-W1

All threaded parts are available with Metric ISO thread or unified coarse (UNC) thread according to dimension table. Alternative materials and surface finishings are available upon request. Contact STAUFF for further information.

**Weld Plate for Double Clamps**  
Type SPAS

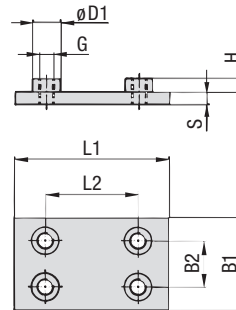
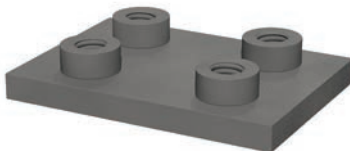

**Ordering Codes**

**Weld Plate \*SPAS-\*3S-\*M-\*W2**

- \* Weld Plate for Double Clamps **SPAS**
- \* STAUFF Group **3S**
- \* Thread code Metric ISO thread **M**  
Unified coarse (UNC) thread **U**
- \* Material code Carbon Steel, uncoated **W1**  
Carbon Steel, phosphated **W2**  
Carbon Steel, zinc/nickel-plated **W3**  
Stainless Steel V2A **W4**  
1.4301 / 1.4305 (AISI 304 / 303) **W4**  
Stainless Steel V4A **W5**  
1.4401 / 1.4571 (AISI 316 / 316 Ti) **W5**

Group	STAUFF	DIN	Dimensions (mm/m)					Thread G	ØD1	Ordering Codes (Standard Options)	
			L1	L2	B1	B2	S				H
3S	1		74	33	60	30,5	8	8	M10	18	SPAS-3S-M-W2
			2.91	1.30	2.36	1.20	.31	.31	3/8-16 UNC	.71	SPAS-3S-U-W2
4S	2		86	45	60	30,5	8	8	M10	18	SPAS-4S-M-W2
			3.39	1.77	2.36	1.20	.31	.31	3/8-16 UNC	.71	SPAS-4S-U-W2
5S	3		100	60	60	30,5	8	8	M10	18	SPAS-5S-M-W2
			3.94	2.36	2.36	1.20	.31	.31	3/8-16 UNC	.71	SPAS-5S-U-W2
6S	4		140	90	90	46	10	8	M12	20	SPAS-6S-M-W2
			5.51	3.54	3.54	1.81	.39	.31	7/16-14 UNC	.78	SPAS-6S-U-W2
7S	5		180	122	120	61	10	12	M16	24	SPAS-7S-M-W2
			7.09	4.80	4.72	2.40	.39	.47	5/8-11 UNC	.94	SPAS-7S-U-W2
8S	6		226	168	160	81	15	18	M20	30	SPAS-8S-M-W1
			8.90	6.61	6.61	3.19	.59	.71	3/4-10 UNC	1.18	SPAS-8S-U-W1
9S	7		270	205	180	91	15	21	M24	35	SPAS-9S-M-W1
			10.63	8.07	7.09	3.58	.59	.83	7/8-9 UNC	1.38	SPAS-9S-U-W1
10S	8		340	265	240	121	25	21	M30	45	SPAS-10S-M-W1
			13.39	10.43	9.45	4.78	.98	.83	1-1/8-7 UNC	1.77	SPAS-10S-U-W1
11S	9		520	395	324	166	30	38	M30	50	SPAS-11S-M-W1
			20.47	15.55	12.76	6.54	1.18	1.50	1-1/4-7 UNC	1.97	SPAS-11S-U-W1
12S	10		680	534	364	186	30	38	M30	50	SPAS-12S-M-W1
			27.16	21.02	14.33	7.32	1.18	1.50	1-1/4-7 UNC	1.97	SPAS-12S-U-W1

All threaded parts are available with Metric ISO thread or unified coarse (UNC) thread according to dimension table. Alternative materials and surface finishings are available upon request. Contact STAUFF for further information.



Elongated Weld Plate for Single Clamps  
Type SPAL-DUEB

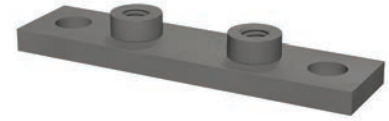
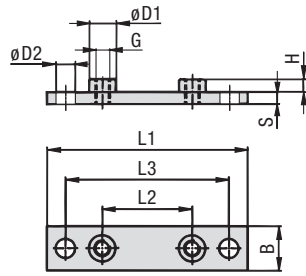

B

Group STAUFF	DIN	Dimensions (mm/m)								Ordering Codes (Standard Options)	
		L1	L2	L3	B	S	H	Thread G	ØD1	ØD2	
3S	1	113	33	85	30	8	8	M10	18	13	SPAL-DUEB-3S-M-W2
		4.45	1.30	3.35	1.18	.31	.31	3/8-16 UNC	.71	.51	SPAL-DUEB-3S-U-W2
4S	2	125	45	97	30	8	8	M10	18	13	SPAL-DUEB-4S-M-W2
		4.92	1.77	3.82	1.18	.31	.31	3/8-16 UNC	.71	.51	SPAL-DUEB-4S-U-W2
5S	3	140	60	112	30	8	8	M10	18	13	SPAL-DUEB-5S-M-W2
		5.51	2.36	4.41	1.18	.31	.31	3/8-16 UNC	.71	.51	SPAL-DUEB-5S-U-W2
6S	4	187	90	155	45	10	8	M12	20	16	SPAL-DUEB-6S-M-W2
		7.36	3.54	6.10	1.77	.39	.12	7/16-14 UNC	.78	.62	SPAL-DUEB-6S-U-W2
7S	5	238	122	198	60	10	12	M16	24	21	SPAL-DUEB-7S-M-W2
		9.37	4.80	7.80	2.36	.39	.47	5/8-11 UNC	.94	.83	SPAL-DUEB-7S-U-W2
8S	6	309	168	259	80	15	18	M20	30	26	SPAL-DUEB-8S-M-W1
		12.17	6.61	10.20	3.15	.59	.71	3/4-10 UNC	1.18	1.02	SPAL-DUEB-8S-U-W1
9S	7	370	205	310	90	15	21	M24	35	31	SPAL-DUEB-9S-M-W1
		14.57	8.07	12.20	3.54	.59	.83	7/8-9 UNC	1.38	1.22	SPAL-DUEB-9S-U-W1
10S	8	460	265	400	120	25	21	M30	45	31	SPAL-DUEB-10S-M-W1
		18.11	10.43	15.75	4.72	.98	.83	1-1/8-7 UNC	1.77	1.22	SPAL-DUEB-10S-U-W1
11S	9	590	395	530	160	30	38	M30	50	31	SPAL-DUEB-11S-M-W1
		23.23	15.55	20.87	6.30	1.18	1.50	1-1/4-7 UNC	1.97	1.22	SPAL-DUEB-11S-U-W1
12S	10	750	534	690	180	30	38	M30	50	31	SPAL-DUEB-12S-M-W1
		29.53	21.02	27.17	7.09	1.18	1.50	1-1/4-7 UNC	1.97	1.22	SPAL-DUEB-12S-U-W1

Ordering Codes

Weld Plate \*SPAL-DUEB-\*3S-\*M-\*W2

- \* Elongated Weld Plate for Single Clamps **SPAL-DUEB**
- \* STAUFF Group **3S**
- \* Thread code Metric ISO thread **M**  
Unified coarse (UNC) thread **U**
- \* Material code Carbon Steel, uncoated **W1**  
Carbon Steel, phosphated **W2**  
Carbon Steel, zinc/nickel-plated **W3**  
Stainless Steel V2A **W4**  
1.4301 / 1.4305 (AISI 304 / 303)  
Stainless Steel V4A **W5**  
1.4401 / 1.4571 (AISI 316 / 316 Ti)

All threaded parts are available with Metric ISO thread or unified coarse (UNC) thread according to dimension table. Alternative materials and surface finishings are available upon request. Contact STAUFF for further information.

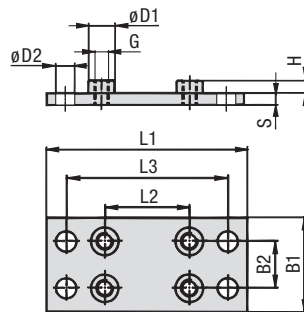
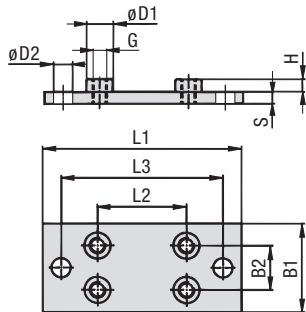

Elongated Weld Plate for Double Clamps  
Type SPAS-DUEB



Design for STAUFF Group 10S to 12S

STAUFF Group 3S to 9S

STAUFF Group 10S to 12S

Group STAUFF	DIN	Dimensions (mm/m)								Ordering Codes (Standard Options)		
		L1	L2	L3	B1	B2	S	H	Thread G	ØD1	ØD2	
3S	1	113	33	85	60	30.5	8	8	M10	18	13	SPAS-DUEB-3S-M-W2
		4.45	1.30	3.35	2.36	1.20	.31	.31	3/8-16 UNC	.71	.51	SPAS-DUEB-3S-U-W2
4S	2	125	45	97	60	30.5	8	8	M10	18	13	SPAS-DUEB-4S-M-W2
		4.92	1.77	3.82	2.36	1.20	.31	.31	3/8-16 UNC	.71	.51	SPAS-DUEB-4S-U-W2
5S	3	140	60	112	60	30.5	8	8	M10	18	13	SPAS-DUEB-5S-M-W2
		5.51	2.36	4.41	2.36	1.20	.31	.31	3/8-16 UNC	.71	.51	SPAS-DUEB-5S-U-W2
6S	4	187	90	155	90	46	10	8	M12	20	16	SPAS-DUEB-6S-M-W2
		7.36	3.54	6.10	3.54	1.81	.39	.31	7/16-14 UNC	.78	.62	SPAS-DUEB-6S-U-W2
7S	5	238	122	198	120	61	10	12	M16	24	21	SPAS-DUEB-7S-M-W2
		9.37	4.80	7.80	4.72	2.40	.39	.47	5/8-11 UNC	.94	.83	SPAS-DUEB-7S-U-W2
8S	6	309	168	259	160	81	15	18	M20	30	26	SPAS-DUEB-8S-M-W1
		12.17	6.61	10.20	6.61	3.19	.59	.71	3/4-10 UNC	1.18	1.02	SPAS-DUEB-8S-U-W1
9S	7	370	205	310	180	91	15	21	M24	35	31	SPAS-DUEB-9S-M-W1
		14.57	8.07	12.20	7.09	3.58	.59	.83	7/8-9 UNC	1.38	1.22	SPAS-DUEB-9S-U-W1
10S	8	460	265	400	240	121	25	21	M30	45	31	SPAS-DUEB-10S-M-W1
		18.11	10.43	15.75	9.45	4.78	.98	.83	1-1/8-7 UNC	1.77	1.22	SPAS-DUEB-10S-U-W1
11S	9	590	395	530	324	166	30	38	M30	50	31	SPAS-DUEB-11S-M-W1
		23.23	15.55	20.87	12.76	6.54	1.18	1.50	1-1/4-7 UNC	1.97	1.22	SPAS-DUEB-11S-U-W1
12S	10	750	534	690	364	186	30	38	M30	50	31	SPAS-DUEB-12S-M-W1
		29.53	21.02	27.17	14.33	7.32	1.18	1.50	1-1/4-7 UNC	1.97	1.22	SPAS-DUEB-12S-U-W1

Ordering Codes

Weld Plate \*SPAS-DUEB-\*3S-\*M-\*W2

- \* Elongated Weld Plate for Double Clamps **SPAS-DUEB**
- \* STAUFF Group **3S**
- \* Thread code Metric ISO thread **M**  
Unified coarse (UNC) thread **U**
- \* Material code Carbon Steel, uncoated **W1**  
Carbon Steel, phosphated **W2**  
Carbon Steel, zinc/nickel-plated **W3**  
Stainless Steel V2A **W4**  
1.4301 / 1.4305 (AISI 304 / 303)  
Stainless Steel V4A **W5**  
1.4401 / 1.4571 (AISI 316 / 316 Ti)

All threaded parts are available with Metric ISO thread or unified coarse (UNC) thread according to dimension table. Alternative materials and surface finishings are available upon request. Contact STAUFF for further information.



**Mounting Rail Nut**  
(for Use with Mounting Rail STSV)  
Type GMV

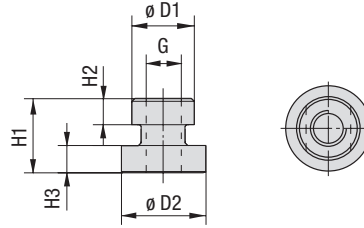

B

**Ordering Codes**

**Mounting Rail Nut \*GMV-\*3-5S\*M-\*W3**

- \* Mounting Rail Nut **GMV**
- \* STAUFF Group 3S to 5S (DIN Group 1 to 3) **3-5S**  
6S (DIN Group 4) **6S**
- \* Thread code Metric ISO thread **M**  
Unified coarse (UNC) thread **U**
- \* Material code Carbon Steel, zinc/nickel-plated **W3**  
Stainless Steel V2A **W4**  
1.4301 / 1.4305 (AISI 304 / 303)  
Stainless Steel V4A **W5**  
1.4401 / 1.4571 (AISI 316 / 316 Ti)

Group STAUFF	DIN	Dimensions (mm/m)					Thread G	Ordering Codes (Standard Options)
		ØD1	ØD2	H1	H2	H3		
3S	1							
4S	2	17,8 .70	24 .94	21 .83	7,6 .30	7,4 .29	M10 3/8-16 UNC	GMV-3-5S-M-W3 GMV-3-5S-U-W3
5S	3							
6S	4	19,8 .78	24 .94	23 .91	8,8 .35	8,8 .35	M12 7/16-14 UNC	GMV-6S-M-W3 GMV-6S-U-W3

All threaded parts are available with Metric ISO thread or unified coarse (UNC) thread according to dimension table. Alternative materials and surface finishings are available upon request. Contact STAUFF for further information.

**Mounting Rail**  
(for Use with Mounting Rail Nut GMV)  
Type STSV

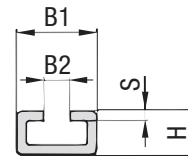

**Ordering Codes**

**Mounting Rail \*STSV-\*1M-\*W1**

- \* Mounting Rail **STSV**
- \* Length of rail 1 m / 3.28ft **1M**  
2 m / 6.56ft **2M**  
Alternative lengths available upon request.  
Contact STAUFF for further information.
- \* Material code Carbon Steel, uncoated **W1**  
Carbon Steel, zinc-plated, blue-chromated **W32**  
Stainless Steel V4A **W5**  
1.4401 / 1.4571 (AISI 316 / 316 Ti)

Group STAUFF	DIN	Dimensions (mm/m)				Ordering Codes (Standard Options)	
		B1	B2	H	S	Length of Rail: 1 m / 3.28ft	Length of Rail: 2 m / 6.56ft
3S	1						
4S	2	40	13	22	5	STSV -1M-W1	STSV -2M-W1
5S	3	1.57	.51	.86	.19		
6S	4						

Alternative materials and surface finishings are available upon request. Contact STAUFF for further information.



**Channel Rail Adaptor**  
(for Use with Various Channel Rails)  
**Type CRA**

**B**

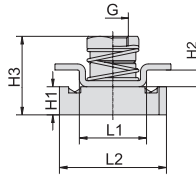
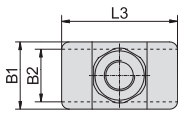

Group STAUFF	DIN	Dimensions (mm/m)									Ordering Codes (Standard Options)		
		Thread G	L1	L2	L3	B1	B2	H1	H2	H3			
3S	1												
4S	2	M10	22	35	38	22	20,5	9,2	5,5	27,5	CRA-3-5S-M-W3		
		3/8-16 UNC	.87	1.38	1.50	.87	.81	.36	.22	1.08	CRA-3-5S-U-W3		
5S	3												
6S	4	M12	21,5	35	45	25	19	9,2	5	27,5	CRA-6S-M-W3		
		7/16-14 UNC	.85	1.38	1.77	.98	.75	.36	.20	1.08	CRA-6S-U-W3		

**Ordering Codes**

**Adaptor**      **\*CRA-\*3-5S-\*M-\*W3**

- \* Channel Rail Adaptor      **CRA**
- \* STAUFF Group      3S to 5S (DIN Group 1 to 3)      **3-5S**  
6S (DIN Group 4)      **6S**
- \* Thread code      Metric ISO thread      **M**  
Unified coarse (UNC) thread      **U**
- \* Material code      Carbon Steel, zinc/nickel-plated      **W3**  
Stainless Steel V4A      **W5**  
1.4401 / 1.4571 (AISI 316 / 316 Ti)

All threaded parts are available with Metric ISO thread or unified coarse (UNC) thread according to dimension table. Alternative materials and surface finishings are available upon request. Contact STAUFF for further information.

**Compatibility with Channel Rails**

The STAUFF Channel Rail Adaptor, type CRA is suitable for various channel rails, including the following types:

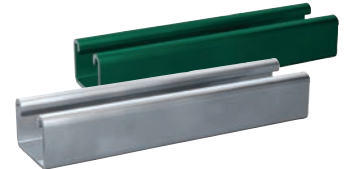

HALFEN	HILTI	UNISTRUT®	STAUFF (Cushion Clamp Series)
HM 41/41	MQ-21, MQ-41, MQ-52, MQ-72	P1000, P1000T, P1000V, P1000VT, P1001	SCS-048-1-PL, SCS-048-1-GR
HZA 41/22	MQ-21U, MQ-41U, MQ-72U	P2000, P2000T	SCS-120-1-PL, SCS-120-1-GR
HZM 41/41	MQ-21D, MQ-41D, MQ-52-72D	P3003, P3003T, P3300V, P3300VT, P3301	See page 149 for technical information.
HZM 41/22		P4000, P4000T	
HL 41/41, HL 41/B2		P5000, P5000T, P5001, P5500, P5500T, P5501	

Contact STAUFF to check compatibility with additional types of channel rails.

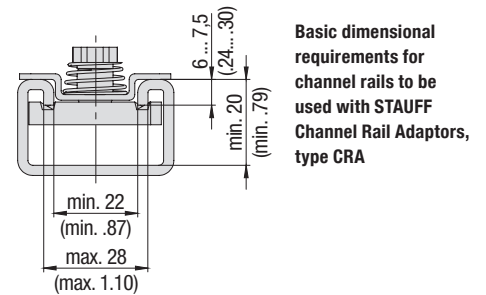

**Recommended Bolt Lengths when using the Channel Rail Adaptor, Type CRA**

Group STAUFF	DIN	Hexagon Head Bolts AS (used with Cover Plates DPAL or DPAS)		Socket Cap Screws IS (used without Cover Plates DPAL or DPAS)	
		Metric ISO thread	Unified coarse (UNC) thread	Metric ISO thread	Unified coarse (UNC) thread
3S	1	M10 x 40	3/8-16 UNC x 1-1/2	M10 x 25	3/8-16 UNC x 1
4S	2	M10 x 55	3/8-16 UNC x 2-1/4	M10 x 40	3/8-16 UNC x 1-1/2
5S	3	M10 x 65	3/8-16 UNC x 2-3/4	M10 x 50	3/8-16 UNC x 2
6S	4	M12 x 100	7/16-14 UNC x 3-3/4	M12 x 75	7/16-14 UNC x 3

Clamp assemblies including Channel Rail Adaptors, type CRA are supplied with the recommended bolt lengths by default. See page 48 for further information on ordering.



### Cover Plate for Single Clamps Type DPAL

B

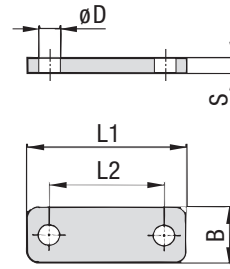

#### Ordering Codes

##### Cover Plate

**\*DPAL-\*3S-\*W2**

* Cover Plate for Single Clamps	<b>DPAL</b>
* STAUFF Group	<b>3S</b>
* Material code	
Carbon Steel, uncoated	<b>W1</b>
Carbon Steel, phosphated	<b>W2</b>
Carbon Steel, zinc/nickel-plated	<b>W3</b>
Stainless Steel V2A	<b>W4</b>
1.4301 / 1.4305 (AISI 304 / 303)	
Stainless Steel V4A	<b>W5</b>
1.4401 / 1.4571 (AISI 316 / 316 Ti)	
Aluminium EN AW-6060	<b>W85</b>
(for group sizes 3S to 5S only)	

Group STAUFF	DIN	Dimensions (mm/m)					Ordering Codes (Standard Options)
		L1	L2	B	S	ØD	
3S	1	55	33	30	8	11	DPAL-3S-W2
		2.16	1.30	1.18	.31	.43	
4S	2	70	45	30	8	11	DPAL-4S-W2
		2.76	1.77	1.18	.31	.43	
5S	3	85	60	30	8	11	DPAL-5S-W2
		3.35	2.36	1.18	.31	.43	
6S	4	115	90	45	10	14	DPAL-6S-W2
		4.53	3.54	1.77	.39	.55	
7S	5	152	122	60	10	19	DPAL-7S-W2
		5.98	4.80	2.36	.39	.75	
8S	6	206	168	80	15	22	DPAL-8S-W1
		8.11	6.61	3.15	.59	.87	
9S	7	251	205	90	15	26	DPAL-9S-W1
		9.88	8.07	3.54	.59	1.02	
10S	8	320	265	120	25	35	DPAL-10S-W1
		12.60	10.43	4.72	.98	1.38	
11S	9	470	395	160	30	35	DPAL-11S-W1
		18.50	15.55	6.30	1.18	1.38	
12S	10	630	534	180	30	35	DPAL-12S-W1
		24.80	21.02	7.09	1.18	1.38	

Alternative materials and surface finishings are available upon request. Contact STAUFF for further information.

### Cover Plate for Double Clamps Type DPAS

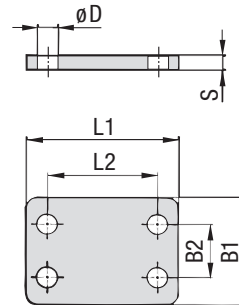

#### Ordering Codes

##### Cover Plate

**\*DPAS-\*3S-\*W2**

* Cover Plate for Double Clamps	<b>DPAS</b>
* STAUFF Group	<b>3S</b>
* Material code	
Carbon Steel, uncoated	<b>W1</b>
Carbon Steel, phosphated	<b>W2</b>
Carbon Steel, zinc/nickel-plated	<b>W3</b>
Stainless Steel V2A	<b>W4</b>
1.4301 / 1.4305 (AISI 304 / 303)	
Stainless Steel V4A	<b>W5</b>
1.4401 / 1.4571 (AISI 316 / 316 Ti)	

Group STAUFF	DIN	Dimensions (mm/m)					Ordering Codes (Standard Options)	
		L1	L2	B1	B2	S		
3S	1	55	33	60	30,5	8	11	DPAS-3S-W2
		2.16	1.30	2.36	1.20	.31	.43	
4S	2	70	45	60	30,5	8	11	DPAS-4S-W2
		2.76	1.77	2.36	1.20	.31	.43	
5S	3	83	60	60	30,5	8	11	DPAS-5S-W2
		3.27	2.36	2.36	1.20	.31	.43	
6S	4	115	90	90	46	10	14	DPAS-6S-W2
		4.53	3.54	3.54	1.81	.39	.55	
7S	5	152	122	120	61	10	19	DPAS-7S-W2
		5.98	4.80	4.72	2.40	.39	.75	
8S	6	206	168	160	81	15	22	DPAS-8S-W1
		8.11	6.61	6.61	3.19	.59	.87	
9S	7	251	205	180	91	15	26	DPAS-9S-W1
		9.88	8.07	7.09	3.58	.59	1.02	
10S	8	320	265	240	121	25	35	DPAS-10S-W1
		12.60	10.43	9.45	4.78	.98	1.38	
11S	9	470	395	321	166	30	35	DPAS-11S-W1
		18.50	15.55	12.64	6.54	1.18	1.38	
12S	10	630	534	361	186	30	35	DPAS-12S-W1
		24.80	21.02	14.21	7.32	1.18	1.38	

Alternative materials and surface finishings are available upon request. Contact STAUFF for further information.



Hexagon Head Bolt  
Type AS

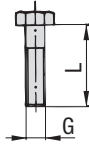

Hexagon Head Bolt AS

(according to DIN 931 / 933 or ANSI / ASME B18.2.1.)

Dimensions applicable only when used with Cover Plates DPAL or DPAS



B

Group STAUFF	DIN	Dimensions (mm/in) Thread G x L	Ordering Codes (Standard Options)
3S	1	M10 x 45	AS-M10x45-W1
		3/8-16 UNC x 1-3/4	AS-3/8-16UNCx1-3/4-W3*
4S	2	M10 x 60	AS-M10x60-W1
		3/8-16 UNC x 2-1/4	AS-3/8-16UNCx2-1/4-W3*
5S	3	M10 x 70	AS-M10x70-W1
		3/8-16 UNC x 2-3/4	AS-3/8-16UNCx2-3/4-W3*
6S	4	M12 x 100	AS-M12x100-W1
		7/16-14 UNC x 4	AS-7/16-14UNCx4-W3*
7S	5	M16 x 130	AS-M16x130-W1
		5/8-11 UNC x 5-1/4	AS-5/8-11UNCx5-1/4-W3*
8S	6	M20 x 190	AS-M20x190-W1
		3/4-10 UNC x 7-1/2	AS-3/4-10UNCx7-1/2-W1
9S	7	M24 x 220	AS-M24x220-W1
		7/8-9 UNC x 8-3/4	AS-7/8-9UNCx8-3/4-W1
10S	8	M30 x 300	AS-M30x300-W1
		1-1/8-7 UNC x 12	AS-1-1/8-7UNCx12-W1
11S	9	M30 x 450	AS-M30x450-W1
		1-1/4-7 UNC x 17-1/2	AS-1-1/4-7UNCx17-1/2-W1
12S	10	M30 x 560	AS-M30x560-W1
		1-1/4-7 UNC x 22	AS-1-1/4-7UNCx22-W1

**Ordering Codes**

**Hexagon Head Bolt \*AS-\*M10x70-\*W1**

- \* Type of bolt: Hexagon Head Bolt (according to DIN 931 / 933 or ANSI / ASME B18.2.1.) **AS**
- \* Thread type and size acc. to dimension table **M10x70**
- \* Material code: Carbon Steel, uncoated **W1**  
Carbon Steel, zinc/nickel-plated **W3**  
Stainless Steel V2A **W4**  
1.4301 / 1.4305 (AISI 304 / 303)  
Stainless Steel V4A **W5**  
1.4401 / 1.4571 (AISI 316 / 316 Ti)

\* Standard finishing option for Heavy Series group sizes 3S to 7S in North America is W3 (Carbon Steel, zinc/nickel-plated).

All threaded parts are available with Metric ISO thread or unified coarse (UNC) thread according to dimension table. Alternative materials and surface finishings are available upon request. Contact STAUFF for further information.

Socket Cap Screw  
Type IS

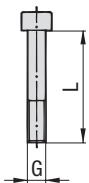

Socket Cap Screw IS

(according to ISO 4762 or ANSI / ASME B18.3)

Dimensions applicable only when used without Cover Plates



Group STAUFF	DIN	Dimensions (mm/in) Thread G x L	Ordering Codes (Standard Options)
3S	1	M10 x 30	IS-M10x30-W1
		3/8-16 UNC x 1	IS-3/8-16UNCx1-W3*
4S	2	M10 x 40	IS-M10x40-W1
		3/8-16 UNC x 1-3/4	IS-3/8-16UNCx1-3/4-W3*
5S	3	M10 x 50	IS-M10x50-W1
		3/8-16 UNC x 2	IS-3/8-16UNCx2-W3*
6S	4	M12 x 80	ISM12x80-W1
		7/16-14 UNC x 3-1/4	IS-7/16-14UNCx3-1/4-W3*

**Ordering Codes**

**Socket Cap Screw \*IS-\*M10x50-\*W1**

- \* Type of Bolt: Socket Cap Screw (according to ISO 4762 or ANSI / ASME B18.3) **IS**
- \* Thread type and size acc. to dimension table **M10x50**
- \* Material code: Carbon Steel, uncoated **W1**  
Carbon Steel, zinc/nickel-plated **W3**  
Stainless Steel V2A **W4**  
1.4301 / 1.4305 (AISI 304 / 303)  
Stainless Steel V4A **W5**  
1.4401 / 1.4571 (AISI 316 / 316 Ti)

All threaded parts are available with Metric ISO thread or unified coarse (UNC) thread according to dimension table. Alternative materials and surface finishings are available upon request. Contact STAUFF for further information.

\* Standard finishing option in North America is W3 (Carbon Steel, zinc/nickel-plated).



### Safety Washer

(for Use with Hexagon Head Bolt AS)

Type SI (DIN 93)

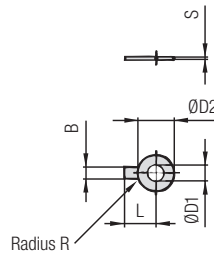

**Safety Washer SI**

(Bend longer tab down towards the side of the clamp body and one side up towards one of the flats of the hexagon head bolt)

#### Ordering Codes

**Safety Washer \*SI-\*10.5-\*DIN93-\*W3**

- \* Safety Washer **SI**
- \* Exact inner diameter ØD1 (mm) **10.5**
- \* Type of washer Safety washer with 1 tab (according to DIN 93) **DIN 93**
- \* Material code Carbon Steel, zinc/nickel-plated **W3**  
Stainless Steel V4A **W5**  
1.4401 / 1.4571 (AISI 316 / 316 Ti)

Group STAUFF	DIN	Dimensions (mm/m)						Ordering Codes (Standard Options)
		ØD1	B	ØD2	L	R	S	
3S	1	10,5	10	26	22	4	0,75	SI-10.5-DIN93-W3
		.41	.39	1.02	.87	.16	.03	
4S	2	10,5	10	26	22	4	0,75	SI-10.5-DIN93-W3
		.41	.39	1.02	.87	.16	.03	
5S	3	10,5	10	26	22	4	0,75	SI-10.5-DIN93-W3
		.41	.39	1.02	.87	.16	.03	
6S	4	13	12	30	28	6	1	SI-13-DIN93-W3
		.51	.47	1.18	1.10	.24	.04	
7S	5	17	15	36	32	6	1	SI-17-DIN93-W3
		.67	.59	1.42	1.26	.24	.04	
8S	6	21	18	42	36	6	1	SI-21-DIN93-W3
		.83	.71	1.65	1.42	.24	.04	
9S	7	25	20	50	42	6	1	SI-25-DIN93-W3
		.98	.79	1.97	1.65	.24	.04	
10S	8	31	26	63	52	10	1,6	SI-31-DIN93-W3
		1.22	1.02	2.48	2.05	.39	.06	
11S	9	31	26	63	52	10	1,6	SI-31-DIN93-W3
		1.22	1.02	2.48	2.05	.39	.06	
12S	10	31	26	63	52	10	1,6	SI-31-DIN93-W3
		1.22	1.02	2.48	2.05	.39	.06	

Safety Washers, type SI are used as locking devices to prevent Hexagon Head Bolts, type AS from loosening. Alternative materials and surface finishings are available upon request. Contact STAUFF for further information.

### Safety Washer

(for Use with Hexagon Head Bolt AS)

Type SI (DIN 463)

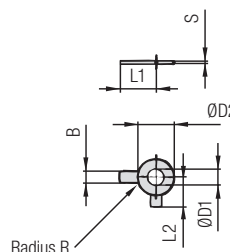

**Safety Washer SI**

(Bend longer tab down towards the side of the clamp body and shorter tab up towards one of the flats of the hexagon head bolt)

#### Ordering Codes

**Safety Washer \*SI-\*10.5-\*DIN463-\*W3**

- \* Safety Washer **SI**
- \* Exact inner diameter ØD1 (mm) **10.5**
- \* Type of washer Safety washer with 2 tabs (according to DIN 463) **DIN 463**
- \* Material code Carbon Steel, zinc/nickel-plated **W3**  
Stainless Steel V4A **W5**  
1.4401 / 1.4571 (AISI 316 / 316 Ti)

Group STAUFF	DIN	Dimensions (mm/m)						Ordering Codes (Standard Options)	
		ØD1	B	ØD2	L1	L2	R		S
3S	1	10,5	10	21	22	13	4	0,75	SI-10.5-DIN463-W3
		.41	.39	.83	.87	.51	.16	.03	
4S	2	10,5	10	21	22	13	4	1	SI-10.5-DIN463-W3
		.41	.39	.83	.87	.51	.16	.04	
5S	3	10,5	10	21	22	13	4	1	SI-10.5-DIN463-W3
		.41	.39	.83	.87	.51	.16	.04	
6S	4	13	12	24	28	15	6	1	SI-13-DIN463-W3
		.51	.47	.94	1.10	.59	.24	.04	
7S	5	17	15	30	32	18	6	1	SI-17-DIN463-W3
		.67	.59	1.18	1.26	.71	.24	.04	
8S	6	21	18	37	36	21	6	1	SI-21-DIN463-W3
		.83	.71	1.46	1.42	.83	.24	.04	
9S	7	25	20	44	42	25	6	1	SI-25-DIN463-W3
		.98	.79	1.73	1.65	.98	.24	.04	
10S	8	31	26	56	52	32	10	1,6	SI-31-DIN463-W3
		1.22	1.02	2.20	2.05	1.26	.39	.06	
11S	9	31	26	56	52	32	10	1,6	SI-31-DIN463-W3
		1.22	1.02	2.20	2.05	1.26	.39	.06	
12S	10	31	26	56	52	32	10	1,6	SI-31-DIN463-W3
		1.22	1.02	2.20	2.05	1.26	.39	.06	

Safety Washers, type SI are used as locking devices to prevent Hexagon Head Bolts, type AS from loosening. Alternative materials and surface finishings are available upon request. Contact STAUFF for further information.

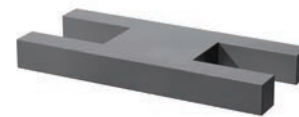
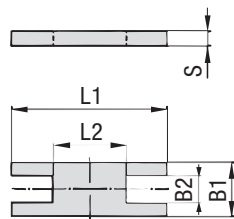

**Safety Locking Plate**  
 (for Use with Stacking Bolt AF)  
**Type SIP**

**B**

Group STAUFF	DIN	Dimensions (mm/in)					Ordering Codes (Standard Options)
		L1	L2	B1	B2	S	
3S	1	57	13	30	15,2	8	SIP-3S-W2
		2.24	.51	1.18	.60	.31	
4S	2	70	26	30	15,2	8	SIP-4S-W2
		2.76	1.02	1.18	.60	.31	
5S	3	85	40	30	15,2	8	SIP-5S-W2
		3.35	1.57	1.18	.60	.31	
6S	4	116	68	45	17,2	10	SIP-6S-W2
		4.57	2.68	1.77	.68	.39	
7S	5	153	96	60	22	10	SIP-7S-W2
		6.02	3.78	2.36	.87	.39	
8S	6	206	130	80	28	15	SIP-8S-W1
		8.11	5.12	3.15	1.10	.59	
9S	7	251	166	90	31	15	SIP-9S-W1
		9.88	6.54	3.54	1.22	.59	
10S	8	317	205	120	49	25	SIP-10-S-W1
		12.48	8.07	4.72	1.93	.98	

**Ordering Codes**
**Safety Locking Plate \*SIP-\*3S-\*W2**

* Safety Locking Plate		SIP
* STAUFF Group		3S
* Material code	Carbon Steel, uncoated	W1
	Carbon Steel, phosphated	W2
	Carbon Steel, zinc/nickel-plated	W3
	Stainless Steel V2A	W4
	1.4301 / 1.4305 (AISI 304 / 303)	
	Stainless Steel V4A	W5
	1.4401 / 1.4571 (AISI 316 / 316 Ti)	

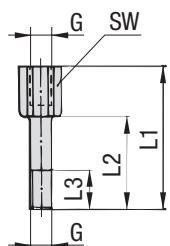
Alternative materials and surface finishings are available upon request. Contact STAUFF for further information.

**Stacking Bolt**  
 (for Use with Safety Locking Plate SIP)  
**Type AF**

Group STAUFF	DIN	Dimensions (mm/in)					Ordering Codes (Standard Options)
		L1	L2	L3 min.	Hex	Thread G	
3S	1	49	25	15	15	M10	AF-3S-M-W2
		1.93	.98	.59	.59	3/8-16 UNC	AF-3S-U-W3*
4S	2	65	40	15	15	M10	AF-4S-M-W2
		2.56	1.57	.59	.59	3/8-16 UNC	AF-4S-U-W3*
5S	3	77	51	15	15	M10	AF-5S-M-W2
		3.03	2.01	.59	.59	3/8-16 UNC	AF-5S-U-W3*
6S	4	110	82	18	17	M12	AF-6S-M-W2
		4.33	3.23	.71	.67	7/16-14 UNC	AF-6S-U-W3*
7S	5	144	110	24	22	M16	AF-7S-M-W2
		5.67	4.33	.94	.87	5/8-11 UNC	AF-7S-U-W3*
8S	6	200	150	30	27	M20	AF-8S-M-W2
		7.87	5.91	1.18	1.06	3/4-10 UNC	AF-8S-U-W1*
9S	7	240	180	50	30	M24	AF-9S-M-W2
		9.45	7.09	1.97	1.18	7/8-9 UNC	AF-9S-U-W1*
10S	8	331	256	62	46	M30	AF-10S-M-W2
		13.03	10.08	2.44	1.81	1-1/8-7 UNC	AF-10S-U-W1*

**Ordering Codes**
**Stacking Bolt \*AF-\*3S-\*M-\*W2**

* Stacking Bolt		AF
* STAUFF Group		3S
* Thread code	Metric ISO thread	M
	Unified coarse (UNC) thread	U
* Material code	Carbon Steel, uncoated	W1
	Carbon Steel, phosphated	W2
	Carbon Steel, zinc/nickel-plated	W3
	Stainless Steel V2A	W4
	1.4301 / 1.4305 (AISI 304 / 303)	
	Stainless Steel V4A	W5
	1.4401 / 1.4571 (AISI 316 / 316 Ti)	

All threaded parts are available with Metric ISO thread or unified coarse (UNC) thread according to dimension table. Alternative materials and surface finishings are available upon request. Contact STAUFF for further information.

\* Standard finishing option for Heavy Series group sizes 3S to 7S in North America is W3 (Carbon Steel, zinc/nickel-plated). Standard finishing option for Heavy Series group sizes 8S to 10S in North America is W1 (Carbon Steel, uncoated).





B

### ① Type of Installation

Please select the type of installation (e.g. Weld Plates, Rail Nuts etc.) and add the corresponding Code to position ① of the order code for your clamp assembly.

Without Installation Equipment  
Code: **none**

#### Installation on Weld Plate

Weld Plate for Single Clamps  
Code: **SPAL**

Weld Plate for Double Clamps  
Code: **SPAS**

Elongated Weld Plate for Single Clamps  
Code: **SPAL-DUEB**

Elongated Weld Plate for Double Clamps  
Code: **SPAS-DUEB**

#### Installation on Mounting / Channel Rail

Mounting Rail Nut  
Code: **GMV** (for STAUFF Group 3S to 6S only)

Channel Rail Adaptor  
Code: **CRA** (for STAUFF Group 3S to 6S only)

### ② Group Size & Diameter

Please select the required group size and diameter and add the corresponding Code to position ② of the order code for your clamp assembly.

Group STAUFF (DIN)	Outside Diameter P / T / H (mm)	Availability of Clamp Body Materials & Designs			Code
		Profiled Design	Type H	Type RI	
3S (1)	6	●	●	○	3006
	6,4	●	●	○	3006.4
	8	●	●	○	3008
	9,5	●	●	○	3009.5
	10	●	●	○	3010
	12	●	●	○	3012
	12,7	●	●	○	3012.7
	13,5	●	●	○	3013.5
	14	●	●	○	3014
	15	●	●	○	3015
	16	●	●	○	3016
	17,2	●	●	○	3017.2
	18	●	●	○	3018
20	●	○	○	3020	

### ② Group Size & Diameter CONTINUATION

Group STAUFF (DIN)	Outside Diameter P / T / H (mm)	Availability of Clamp Body Materials & Designs			Code
		Profiled Design	Type H	Type RI	
4S (2)	6	○	○	●	4006
	8	○	○	●	4008
	10	○	○	●	4010
	12	○	○	●	4012
	12,7	○	○	●	4012.7
	14	○	○	●	4014
	15	○	○	●	4015
	16	○	○	●	4016
	17,2	○	○	●	4017.2
	18	○	○	●	4018
	19	●	●	●	4019
	20	●	●	○	4020
	21,3	●	●	○	4021.3
	22	●	●	○	4022
	25	●	●	○	4025
	25,4	●	●	○	4025.4
	26,9	●	●	○	4026.9
28	●	●	○	4028	
30	●	●	○	4030	
5S (3)	20	○	○	●	5020
	21,3	○	○	●	5021.3
	22	○	○	●	5022
	25	○	○	●	5025
	26,9	○	○	●	5026.9
	28	○	○	●	5028
	30	●	●	●	5030
	32	●	●	●	5032
	33,7	●	●	○	5033.7
	35	●	●	○	5035
6S (4)	38	●	●	○	5038
	40	●	●	○	5040
	41,3	●	●	○	5041.3
	42	●	●	○	5042
	32	○	○	●	6032
	33,7	○	○	●	6033.7
	35	○	○	●	6035
	38	●	●	○	6038
	38,7	○	○	●	6038.7
	40	○	○	●	6040
	42	●	●	●	6042
	44,5	●	●	○	6044.5
	45,5	○	○	●	6045.5
48	○	○	●	6048	
48,3	●	●	○	6048.3	
50,8	●	●	○	6050.8	
51	○	○	●	6051	
53,4	○	○	●	6053.4	
54	●	○	○	6054	

### ② Group Size & Diameter CONTINUATION

Group STAUFF (DIN)	Outside Diameter P / T / H (mm)	Availability of Clamp Body Materials & Designs			Code	
		Profiled Design	Type H	Type RI		
6S (4)	55	●	●	○	6055	
	56,4	○	○	●	6056.4	
	57	●	●	○	6057	
	57,2	●	●	○	6057.2	
	60,3	●	●	○	6060.3	
	63,5	●	●	○	6063.5	
	65	●	●	○	6065	
	70	●	●	○	6070	
	7S (5)	55	○	○	●	7055
		57	○	○	●	7057
60		○	○	●	7060	
60,3		●	○	○	7060.3	
63,5		○	○	●	7063.5	
65		●	○	●	7065	
70		●	○	●	7070	
72		○	○	●	7072	
73		●	○	○	7073	
75		●	○	○	7075	
76		○	○	●	7076	
76,1		●	○	○	7076.1	
8S (6)	80	●	○	○	7080	
	82,5	●	○	○	7082.5	
	88,9	●	○	○	7088.9	
	80	○	○	●	8080	
	88,9	●	○	●	8088.9	
	100	●	○	○	8100	
	102	●	○	●	8102	
	108	●	○	○	8108	
	114	●	○	○	8114	
	127	●	○	○	8127	
9S (7)	133	●	○	○	8133	
	114	○	○	●	9114	
	127	●	○	○	9127	
	133	●	○	●	9133	
	140	●	○	●	9140	
	152	●	○	○	9152	
	159	●	○	○	9159	
	165	●	○	○	9165	
	168	●	○	○	9168	
	10S (8)	150	○	○	●	10150
165		○	○	●	10165	
168		●	○	●	10168	
172		○	○	●	10172	
177,8		●	○	○	10177.8	
193,7		●	○	○	10193.7	
203		●	○	○	10203	
216		●	○	○	10216	
219		●	○	○	10219	
11S (9)		219	●	○	○	11219
	273	●	○	○	11273	
	324	●	○	○	11324	
12S (10)	356	●	○	○	12356	
	406	●	○	○	12406	

● Standard Option



Please see pages 50 and 51 with detailed order examples for some of the most popular Heavy Series clamp assemblies.

### ③ Clamp Body Design & Material

Please select the design and material of your clamp body and add the corresponding **Code** to position ③ of the order code for your clamp assembly.

Please check the availability of the selected clamp body design and material according to the matrix table in ②.

#### Profiled Design

**Polypropylene**  
Code: **PP**

**Polypropylene** (Colour: Black)  
Code: **PP-BK**

**Polyamide**  
Code: **PA**

**Thermoplastic Elastomer** (87 Shore-A)  
Code: **SA** (for STAUFF Group 3S to 6S only)

**Aluminium**  
Code: **AL**

#### Type H (Smooth)

**Polypropylene**  
Code: **PP-H** (for STAUFF Group 3S to 6S only)

**Polypropylene** (Colour: Black; 3S to 6S only)  
Code: **PP-H-BK**

**Polyamide**  
Code: **PA-H** (for STAUFF Group 3S to 6S only)

**Thermoplastic Elastomer** (87 Shore-A)  
Code: **SA-H** (for STAUFF Group 3S to 6S only)

#### Type RI (with Elastomer Insert)

**Polypropylene**  
Code: **PP-R** (for STAUFF Group 4S to 10S only)

**Polyamide**  
Code: **PA-R** (for STAUFF Group 4S to 10S only)

See pages 154 / 155 for material properties and technical information.

Please contact STAUFF for further details on fire-proof clamp body materials, tested and approved according to several international fire-protection standards.

### ④ Mounting & Fitting Combination

Please select the mounting and fitting combination (e.g. bolts, screws, cover plates etc.) and add the corresponding **Code** to position ④ of the order code for your clamp assembly.

#### Installation with Cover Plate and Bolts

**Cover Plate for Single Clamps DPAL with Hexagon Head Bolts AS**  
Code: **DPAL-AS**

**Cover Plate for Double Clamps DPAS with Hexagon Head Bolts AS**  
Code: **DPAS-AS**

**Cover Plate for Single Clamps DPAL with Socket Cap Screws IS\***  
Code: **DPAL-IS** (for STAUFF Group 3S to 6S only)

#### Installation with Locking Plate and Bolts

**Safety Locking Plate SIP with Stacking Bolts AF**  
Code: **SIP-AF**

#### Installation with Bolts only

**Socket Cap Screws IS**  
Code: **IS**

\* Special lengths of Socket Cap Screws IS required. For exact lengths, please see details of Hexagon Head Bolt, type AS (for use with Cover Plates DPAL or DPAS) on page 45.

### ⑤ Thread Type

Please select the required thread type and add the corresponding **Code** to position ⑤ of the order code for your clamp assembly.

**Metric ISO thread**  
Code: **M**

**Unified coarse (UNC) thread**  
Code: **U**

All threaded parts are available with Metric ISO thread or unified coarse (UNC) thread according to dimension table.

### ⑥ Material & Surface Finishing

Please select the required material & surface finishing of the metal parts and add the corresponding **Code** to position ⑥ of the order code for your clamp assembly.

Metal parts made of Carbon Steel, uncoated **W1**

Metal parts made of Carbon Steel, phosphated **W2**

Metal parts made of Carbon Steel, zinc/nickel-plated **W3**

Metal parts made of Stainless Steel V2A 1.4301 / 1.4305 (AISI 304 / 303) **W4**

Metal parts made of Stainless Steel V4A 1.4401 / 1.4571 (AISI 316 / 316 Ti) **W5**

Weld Plate made of Carbon Steel, phosphated; Other metal parts made of Carbon Steel, zinc/nickel-plated **W10**

Weld Plate and Cover Plate made of Carbon Steel, phosphated; Bolts made of Carbon Steel, uncoated **W12**

Mounting Rail Nuts made of Carbon Steel, zinc/nickel-plated; Cover Plate made of Carbon Steel, phosphated; Bolts made of Carbon Steel, uncoated **W13**

Weld Plate / Cover Plate made of Carbon Steel, phosphated; Bolts made of Carbon Steel, zinc/nickel-plated **W15**

Mounting Rail Nuts made of Carbon Steel, zinc/nickel-plated; Cover Plate made of Carbon Steel, phosphated; Bolts made of Carbon Steel, zinc/nickel-plated **W16**

Safety Locking Plate made of Carbon Steel, phosphated; Stacking Bolts made of Carbon Steel, zinc/nickel-plated **W17**

Safety Locking Plate made of Carbon Steel, uncoated; Stacking Bolts made of Carbon Steel, phosphated **W18**

Cover Plate made of Carbon Steel, phosphated; Bolts made of Carbon Steel, uncoated **W19**

Individual combinations of alternative materials and surface finishings are available upon request. Contact STAUFF for further information.

### ⑦ Assembling & Kitting

If required, please select an additional assembling and kitting option and add the corresponding **Code** to the last position of the order code for your clamp assembly.

**Components supplied separately**  
Code: **none** (standard option)

**Components assembled**  
Code: **A** (special option)

**Components packed in kits**  
Code: **K** (special option)



B



- 2x **Hexagon Head Bolt**  
Surface: W1  
Thread: Metric
- 1x **Cover Plate for Single Clamps**  
Surface: W2
- 1x **Clamp Body** (two halves)  
STAUFF Group 3S (DIN 1)  
O.D. 6 mm / .24 in  
Material: Polypropylene  
Profiled inside surface with tension clearance
- 1x **Weld Plate for Single Clamps**  
Surface: W2  
Thread: Metric

**Order Code**

**SPAL-3006-PP-DPAL-AS-M-W12**

W12 (STAUFF Group 3S to 7S) and W1 (STAUFF Group 8S to 12S) are the standard options for this type of installation.



- 4x **Hexagon Head Bolt**  
Surface: W1  
Thread: Metric
- 1x **Cover Plate for Double Clamps**  
Surface: W2
- 2x **Clamp Body** (four halves)  
STAUFF Group 3S (DIN 1)  
O.D. 6 mm / .24 in  
Material: Polypropylene  
Profiled inside surface with tension clearance
- 1x **Weld Plate for Double Clamps**  
Surface: W2  
Thread: Metric

**Order Code**

**SPAS-3006-PP-DPAS-AS-M-W12**

W12 (STAUFF Group 3S to 7S) and W1 (STAUFF Group 8S to 12S) are the standard options for this type of installation.



- 2x **Hexagon Head Bolt**  
Surface: W1  
Thread: Metric
- 1x **Cover Plate for Single Clamps**  
Surface: W2
- 1x **Clamp Body** (two halves)  
STAUFF Group 3S (DIN 1)  
O.D. 6 mm / .24 in  
Material: Polypropylene  
Profiled inside surface with tension clearance
- 1x **Elongated Weld Plate for Single Clamps**  
Surface: W2  
Thread: Metric

**Order Code**

**SPAL-DUEB-3006-PP-DPAL-AS-M-W12**

W12 (STAUFF Group 3S to 7S) and W1 (STAUFF Group 8S to 12S) are the standard options for this type of installation.



- 4x **Hexagon Head Bolt**  
Surface: W1  
Thread: Metric
- 1x **Cover Plate for Double Clamps**  
Surface: W2
- 2x **Clamp Body** (four halves)  
STAUFF Group 3S (DIN 1)  
O.D. 6 mm / .24 in  
Material: Polypropylene  
Profiled inside surface with tension clearance
- 1x **Elongated Weld Plate for Double Clamps**  
Surface: W2  
Thread: Metric

**Order Code**

**SPAS-DUEB-3006-PP-DPAS-AS-M-W12**

W12 (STAUFF Group 3S to 7S) and W1 (STAUFF Group 8S to 12S) are the standard options for this type of installation.



- 2x **Socket Cap Screw**  
Surface: W1  
Thread: Metric
- 1x **Clamp Body** (two halves)  
STAUFF Group 3S (DIN 1)  
O.D. 6 mm / .24 in  
Material: Polypropylene  
Profiled inside surface with tension clearance
- 1x **Weld Plate for Single Clamps**  
Surface: W2  
Thread: Metric

**Order Code**

**SPAL-3006-PP-IS-M-W12**

W12 is the standard option for this type of installation. Available up to STAUFF Group 6S (DIN Group 4) only.



- 2x **Socket Cap Screw**  
Surface: W1  
Thread: Metric
- 1x **Clamp Body** (two halves)  
STAUFF Group 3S (DIN 1)  
O.D. 6 mm / .24 in  
Material: Polypropylene  
Profiled inside surface with tension clearance
- 1x **Elongated Weld Plate for Single Clamps**  
Surface: W2  
Thread: Metric

**Order Code**

**SPAL-DUEB-3006-PP-IS-M-W12**

W12 is the standard option for this type of installation. Available up to STAUFF Group 6S (DIN Group 4) only.





- 2x **Hexagon Head Bolt**  
Surface: W1  
Thread: Metric
- 1x **Cover Plate for Single Clamps**  
Surface: W2
- 1x **Clamp Body** (two halves)  
STAUFF Group 3S (DIN 1)  
O.D. 6 mm / .24 in  
Material: Polypropylene  
Profiled inside surface with tension clearance
- 2x **Mounting Rail Nut**  
Surface: W3  
Thread: Metric

**Order Code** (Mounting Rail STSV not included.)

**GMV-3006-PP-DPAL-AS-M-W13**

W13 is the standard option for this type of installation. Available up to STAUFF Group 6S (DIN Group 4) only.



- 2x **Socket Cap Screw**  
Surface: W1  
Thread: Metric
- 1x **Clamp Body** (two halves)  
STAUFF Group 3S (DIN 1)  
O.D. 6 mm / .24 in  
Material: Polypropylene  
Profiled inside surface with tension clearance
- 2x **Mounting Rail Nut**  
Surface: W3  
Thread: Metric

**Order Code** (Mounting Rail STSV not included.)

**GMV-3006-PP-IS-M-W13**

W13 is the standard option for this type of installation. Available up to STAUFF Group 6S (DIN Group 4) only.



- 2x **Hexagon Head Bolt**  
Surface: W1  
Thread: Metric
- 1x **Cover Plate for Single Clamps**  
Surface: W2
- 1x **Clamp Body** (two halves)  
STAUFF Group 3S (DIN 1)  
O.D. 6 mm / .24 in  
Material: Polypropylene  
Profiled inside surface with tension clearance

**Order Code**

**3006-PP-DPAL-AS-M-W19**

W19 (STAUFF Group 3S to 7S) and W1 (STAUFF Group 8S to 12S) are the standard options for this type of installation.



- 2x **Stacking Bolt**  
Surface: W2  
Thread: Metric
- 1x **Safety Locking Plate**  
Surface: W2
- 1x **Clamp Body** (two halves)  
STAUFF Group 3S (DIN 1)  
O.D. 6 mm / .24 in  
Material: Polypropylene  
Profiled inside surface with tension clearance

**Order Code**

**3006-PP-SIP-AF-M-W2**

W2 (STAUFF Group 3S to 7S) and W18 (STAUFF Group 8S to 10S) are the standard options for this type of installation. Available up to STAUFF Group 10S (DIN Group 8) only.

### Thread codes

All threaded parts are available with Metric ISO thread or unified coarse (UNC) thread according to dimension table.

Metric ISO thread	<b>M</b>
Unified coarse (UNC) thread	<b>U</b>

### Material codes

The below listed material codes describe the materials and surface finishings of metal parts that are most relevant for Heavy Series clamp assemblies. Individual combinations of alternative materials and surface finishings are available upon request. Contact STAUFF for further information.

Metal parts made of Carbon Steel, uncoated	<b>W1</b>
Metal parts made of Carbon Steel, phosphated	<b>W2</b>
Metal parts made of Carbon Steel, zinc/nickel-plated	<b>W3</b>
Metal parts made of Stainless Steel V2A: 1.4301 / 1.4305 (AISI 304 / 303)	<b>W4</b>
Metal parts made of Stainless Steel V4A: 1.4401 / 1.4571 (AISI 316 / 316 Ti)	<b>W5</b>
Weld Plate made of Carbon Steel, phosphated; Other metal parts made of Carbon Steel, zinc/nickel-plated	<b>W10</b>
Weld Plate and Cover Plate made of Carbon Steel, phosphated; Bolts made of Carbon Steel, uncoated	<b>W12</b>
Mounting Rails Nut made of Carbon Steel, zinc/nickel-plated; Cover Plate made of Carbon Steel, phosphated; Bolts made of Carbon Steel, uncoated	<b>W13</b>
Weld Plate and Cover Plate made of Carbon Steel, phosphated; Bolts made of Carbon Steel, zinc/nickel-plated	<b>W15</b>
Mounting Rail Nuts made of Carbon Steel, zinc/nickel-plated; Cover Plate made of Carbon Steel, phosphated; Bolts made of Carbon Steel, zinc/nickel-plated	<b>W16</b>
Safety Locking Plate made of Carbon Steel, phosphated; Bolts made of Carbon Steel, zinc/nickel-plated	<b>W17</b>
Safety Locking Plate made of Carbon Steel, uncoated; Bolts made of Carbon Steel, phosphated	<b>W18</b>
Cover Plate made of Carbon Steel, phosphated; Bolts made of Carbon Steel, uncoated	<b>W19</b>



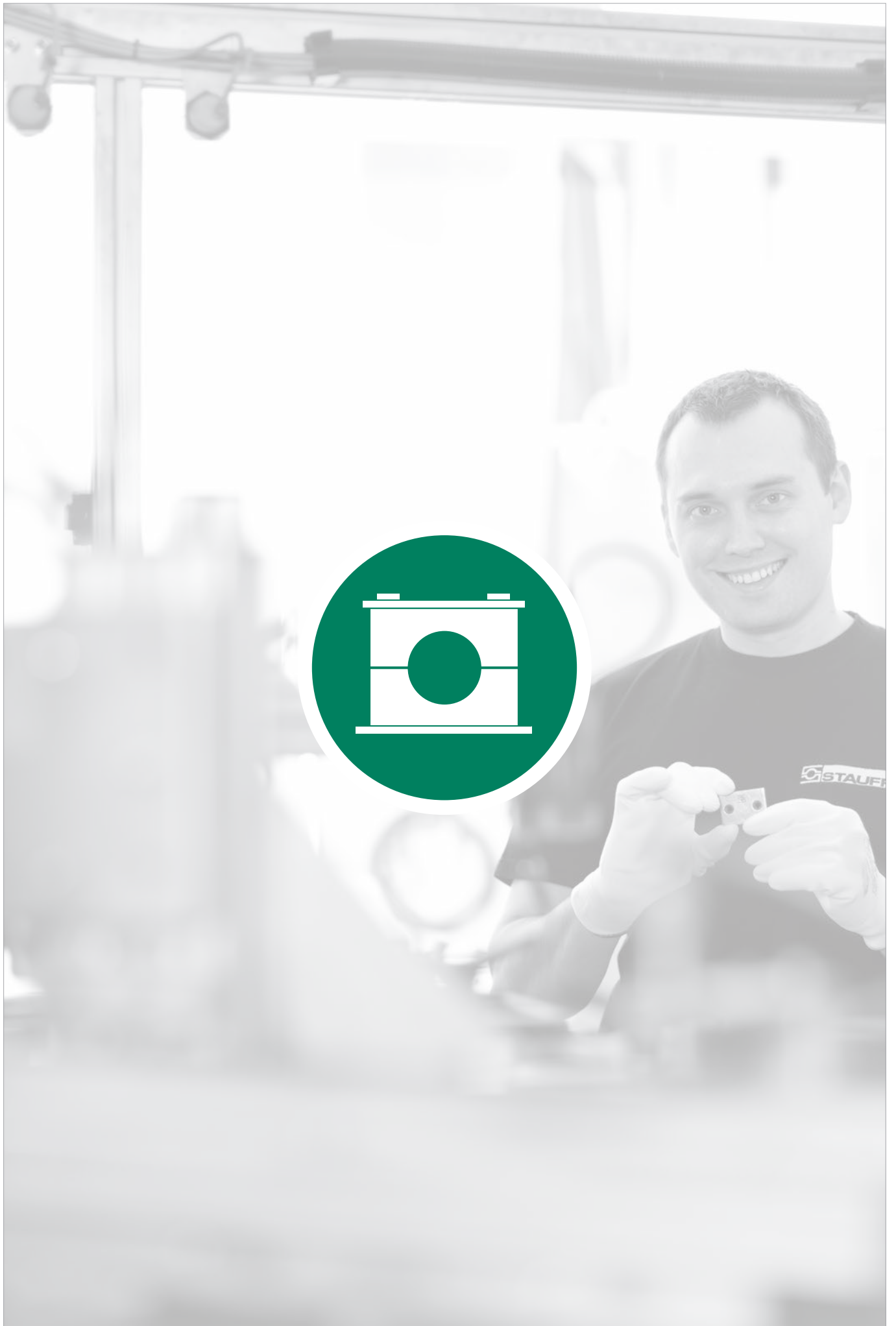



**Clamp Body**  
Profiled Inside Surface with Tension Clearance

54



**Clamp Body**  
Smooth Inside Surface without Tension Clearance

54



**Single Weld Plate**

SP

55



**Group Weld Plate**

RAP

55



**Hexagon Rail Nut**

SM / SMG

56



**Mounting Rail**

TS

56



**Channel Rail Adaptor**

CRA

57



**Cover Plate**

GD

58



**Hexagon Head Bolt**

AS

58



**Socket Cap Screw**

IS

59



**Safety Locking Plate**

SI

60



**Safety Locking Plate**

SIV

60



**Stacking Bolt**

AF

61

**Clamp Assemblies**

62

C



### Clamp Body - Profiled Design

Profiled Inside Surface with Tension Clearance

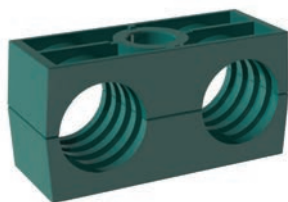

### Clamp Body - Type H

Smooth Inside Surface w/o Tension Clearance

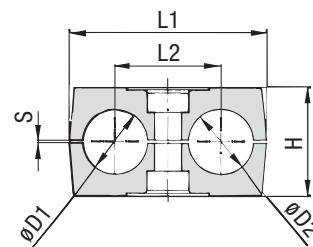
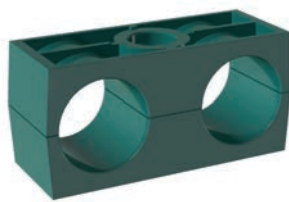

#### Ordering Codes

#### Clamp Body

**\*1\*06/06\*-PP**

One clamp body is consisting of two clamp halves.

- \* 1<sup>st</sup> Part of STAUFF Group 1
- \* Exact outside diameters Ø D1 / Ø D2 (mm) 06/06
- \* Material code (see below) PP

#### Designs & Standard Materials

**Polypropylene - Profiled Design**  
 Profiled inside surface with tension clearance  
 Colour: Green  
 Material code: **PP**

**Polypropylene - Profiled Design**  
 Profiled inside surface with tension clearance  
 Colour: Black  
 Material code: **PP-BK**

**Polypropylene - Type H**  
 Smooth inside surface without tension clearance  
 Colour: Green  
 Material code: **PP-H**

**Polypropylene - Type H**  
 Smooth inside surface without tension clearance  
 Colour: Black  
 Material code: **PP-H-BK**

**Polyamide - Profiled Design**  
 Profiled inside surface with tension clearance  
 Colour: Black  
 Material code: **PA**

**Polyamide - Type H**  
 Smooth inside surface without tension clearance  
 Colour: Black  
 Material code: **PA-H**

See pages 154 / 155 for properties and technical information.

#### Special Materials

Please contact STAUFF for further details on fire-proof clamp body materials, tested and approved according to several international fire-protection standards (such as BS 6853, EN 45545-2, UL 94 and many more).

See pages 156 / 157 for material properties and technical information.

#### Product Features

- Proven, tested and trusted product in various markets
- Profiled design recommended for the safe installation of rigid pipes and tubes; type H recommended for the safe installation of hoses and cables
- Available for all commonly used pipe and tube outside diameters
- Environmental protection due to vibration/noise reducing design
- Excellent weathering resistance, even under extreme conditions

Group	STAUFF	DIN	Outside Diameter		Nominal Bore	Copper Tube	Ordering Codes	Dimensions (mm/in)								
			Pipe / Tube / Hose	Pipe				Ø D1 / Ø D2 (mm)	(in)	Pipe (in)	ASTM B88 (in)	(**-* = Material)	L1	L2	H	S min.
1D	1	6					106/06-**-*									
		6,4	1/4				106.4/06.4-**-*									
		8	5/16				108/08-**-*	36	20	27	0,6	26,5	30			
		9,5	3/8		1/4		109.5/09.5-**-*	1.42	.79	1.06	.02	1.04	1.18			
		10			1/8		110/10-**-*									
		12					112/12-**-*									
2D	2	12,7	1/2		3/8		212.7/12.7-**-*									
		13,5			1/4		213.5/13.5-**-*									
		14					214/14-**-*									
		15					215/15-**-*	53	29	27	0,7	26	30			
		16	5/8		1/2		216/16-**-*	2.09	1.14	1.06	.03	1.02	1.18			
		17,2			3/8		217.2/17.2-**-*									
3D	3	18					218/18-**-*									
		19	3/4				319/19-**-*									
		20					320/20-**-*									
		21,3			1/2		321.3/21.3-**-*	67	36	37	0,7	36,5	30			
		22	7/8		3/4		322/22-**-*	2.64	1.42	1.46	.03	1.44	1.18			
		25					325/25-**-*									
4D	4	25,4	1				325.4/25.4-**-*									
		26,9			3/4		426.9/26.9-**-*									
		28					428/28-**-*	80	45	40	0,7	38	30			
5D	5	30					430/30-**-*	3.15	1.77	1.57	.03	1.46	1.18			
		32	1-1/4				532/32-**-*									
		33,7			1		533.7/33.7-**-*									
		35			1-1/4		535/35-**-*	106	56	53	0,7	52	30			
		38	1-1/2				538/38-**-*	4.17	2.20	2.09	.03	2.04	1.18			
		40					540/40-**-*									
42			1-1/4		542/42-**-*											

Additional outside diameters and combinations of different outside diameters are available upon request. Please contact STAUFF for further information.



Single Weld Plate  
Type SP

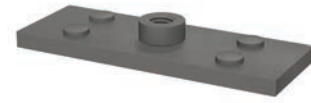
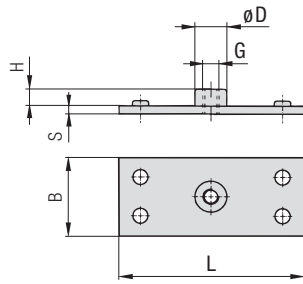

C

Group STAUFF	DIN	Dimensions (mm/in)						Ordering Codes (Standard Options)	
		L	B	S	H	ØD	Thread G		
1D	1	37	30	3	6,5	12	M6	SP-1D-M-W2	
		1.46	1.18	.12	.26	.47	1/4-20 UNC	SP-1D-U-W2	
2D	2	55	30	5	6	14	M8	SP-2D-M-W2	
		2.17	1.18	.20	.24	.55	5/16-18 UNC	SP-2D-U-W2	
3D	3	70	30	5	6	14	M8	SP-3D-M-W2	
		2.76	1.18	.20	.24	.55	5/16-18 UNC	SP-3D-U-W2	
4D	4	85	30	5	6	14	M8	SP-4D-M-W2	
		3.35	1.18	.20	.24	.55	5/16-18 UNC	SP-4D-U-W2	
5D	5	110	30	5	6	14	M8	SP-5D-M-W2	
		4.33	1.18	.20	.24	.55	5/16-18 UNC	SP-5D-U-W2	

Ordering Codes

Weld Plate

**\*SP-\*1D-\*M-\*W2**

- \* Single Weld Plate **SP**
- \* STAUFF Group **1D**
- \* Thread code Metric ISO thread **M**  
Unified coarse (UNC) thread **U**
- \* Material code Carbon Steel, phosphated **W2**  
Carbon Steel, zinc/nickel-plated **W3**  
Stainless Steel V2A **W4**  
1.4301 / 1.4305 (AISI 304 / 303) **W4**  
Stainless Steel V4A **W5**  
1.4401 / 1.4571 (AISI 316 / 316 Ti) **W5**

All threaded parts are available with Metric ISO thread or unified coarse (UNC) thread according to dimension table. Alternative materials and surface finishings are available upon request. Contact STAUFF for further information.

Group Weld Plate  
for 5 Clamp Bodies  
Type RAP

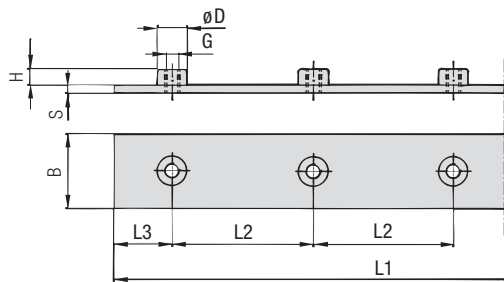

Group STAUFF	DIN	Dimensions (mm/in)							Ordering Codes (Standard Options)		
		L1	L2	L3	B	S	H	ØD	Thread G		
1D	1	196	40	18	30	3	6,5	12	M6	RAP-1D-40-5-M-W1	
		7.72	1.57	.71	1.18	.12	.26	.47	1/4-20 UNC	RAP-1D-40-5-U-W1	
2D	2	288	58	28	30	5	6	14	M8	RAP-2D-58-5-M-W1	
		11.34	2.28	1.10	1.18	.20	.24	.55	5/16-18 UNC	RAP-2D-58-5-U-W1	
3D	3	358	72	35	30	5	6	14	M8	RAP-3D-72-5-M-W1	
		14.09	2.83	1.37	1.18	.20	.24	.55	5/16-18 UNC	RAP-3D-72-5-U-W1	
4D	4	444	90	42	30	5	6	14	M8	RAP-4D-90-5-M-W1	
		17.48	3.54	1.65	1.18	.20	.24	.55	5/16-18 UNC	RAP-4D-90-5-U-W1	
5D	5	558	112	55	30	5	6	14	M8	RAP-5D-112-5-M-W1	
		21.97	4.41	2.16	1.18	.20	.24	.55	5/16-18 UNC	RAP-5D-112-5-U-W1	

Ordering Codes

Weld Plate

**\*RAP-\*1D-\*40-\*5-\*M-\*W1**

- \* Group Weld Plate **RAP**
- \* STAUFF Group **1D**
- \* Pipe Center Spacing L2 (mm) **40**
- \* Number of Clamps **5**
- \* Thread code Metric ISO thread **M**  
Unified coarse (UNC) thread **U**
- \* Material code Carbon Steel, uncoated **W1**  
Carbon Steel, phosphated **W2**  
Carbon Steel, zinc/nickel-plated **W3**  
Stainless Steel V2A **W4**  
1.4301 / 1.4305 (AISI 304 / 303) **W4**  
Stainless Steel V4A **W5**  
1.4401 / 1.4571 (AISI 316 / 316 Ti) **W5**

All threaded parts are available with Metric ISO thread or unified coarse (UNC) thread according to dimension table. Alternative materials and surface finishings are available upon request. Contact STAUFF for further information.



### Hexagon Rail Nut

(for Use with Mounting Rail TS)

#### Type SM / SMG

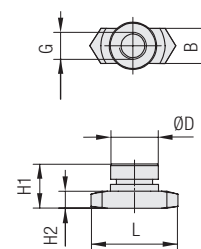
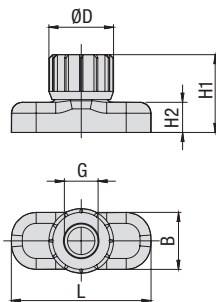
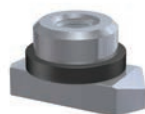

STAUFF Group 1D

STAUFF Group 2D to 5D

STAUFF Group 1D

STAUFF Group 2D to 5D

### Ordering Codes

#### Hexagon Rail Nut \*SM-\*1-8/1D-\*M-\*W3

\* Hexagon Rail Nut

Carbon Steel **SM**  
Stainless Steel **SMG**

\* STAUFF Group 1D (DIN Group 1) **1-8/1D**  
2D to 5D (DIN Group 2 to 5) **2-5D**

\* Thread code Metric ISO thread **M**  
Unified coarse (UNC) thread **U**

\* Material code Carbon Steel, zinc/nickel-plated **W3**  
Stainless Steel V2A **W4**  
1.4301 / 1.4305 (AISI 304 / 303)  
Stainless Steel V4A **W5**  
1.4401 / 1.4571 (AISI 316 / 316 Ti)

Group STAUFF	DIN	Dimensions (mm/m)						Ordering Codes (Standard Options)
		Thread G	L	B	H1	H2	ØD	
1D	1	M6	25,5	10,4	14,2	5,5	12	SM-1-8/1D-M-W3
		1/4-20 UNC	1.00	.41	.56	.22	.47	SM-1-8/1D-U-W3
2D	2							
3D	3	M8	25,5	10,4	13	5	14	SM-2-5D-M-W3
		5/16-18 UNC	1.00	.41	.51	.20	.55	SM-2-5D-U-W3
4D	4							
5D	5							

The Hexagon Rail Nut, type SM-1-8/1D is also suitable for Standard Series, STAUFF Group 1 to 8.

All threaded parts are available with Metric ISO thread or unified coarse (UNC) thread according to dimension table. Alternative materials and surface finishings are available upon request. Contact STAUFF for further information.

### Mounting Rail

(for Use with Hexagon Rail Nut SM / SMG)

#### Type TS

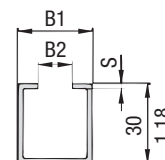
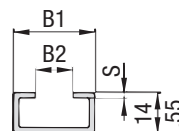
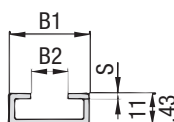

Mounting Rail TS-11

Mounting Rail TS-14

Mounting Rail TS-30

### Ordering Codes

#### Mounting Rail \*TS-\*11-\*1M-\*W1

\* Mounting Rail **TS**

\* Height of rail 11 mm / .43 in **11**  
14 mm / .55 in **14**  
30 mm / 1.18 in **30**

\* Length of rail 1 m / 3.28 ft **1M**  
2 m / 6.56 ft **2M**

Alternative lengths available upon request. Contact STAUFF for further information.

\* Material code Carbon Steel, uncoated **W1**  
Carbon Steel, hot-dip galvanised **W98**  
Stainless Steel V2A **W4**  
1.4301 / 1.4305 (AISI 304 / 303)  
Stainless Steel V4A **W5**  
1.4401 / 1.4571 (AISI 316 / 316 Ti)

Group STAUFF	DIN	Dimensions (mm/m)			Ordering Codes (Standard Options)	
		B1	B2	S	Length of Rail: 1 m / 3.28 ft	Length of Rail: 2 m / 6.56 ft
1D	1				Height 11 mm / .43 in <b>TS-11-1M-W1</b>	Height 11 mm / .43 in <b>TS-11-2M-W1</b>
2D	2					
3D	3	28	11	2	Height 14 mm / .55 in <b>TS-14-1M-W1</b>	Height 14 mm / .55 in <b>TS-14-2M-W1</b>
		1.10	.43	.08		
4D	4					
5D	5				Height 30 mm / 1.18 in <b>TS-30-1M-W1</b>	Height 30 mm / 1.18 in <b>TS-30-2M-W1</b>

Mounting Rails, type TS-11/14/30 are suitable for all Twin Series and Standard Series group sizes.

Alternative materials and surface finishings are available upon request. Contact STAUFF for further information.

Dimensional drawings: All dimensions in mm (in).



**Channel Rail Adaptor**  
(for Use with Various Channel Rails)  
**Type CRA**

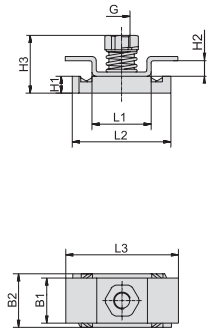

**STAUFF Group 1D**

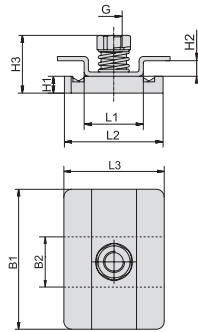

**STAUFF Group 2-3D / 4-5D**



**C**

Group STAUFF	DIN	Dimensions (mm/in)									Ordering Codes (Standard Options)	
		Thread G	L1	L2	L3	B1	B2	H1	H2	H3		
1D	1	M6	21	35	40	16	19	6	5,5	20,5	CRA-1-8/1D-M-W3	
		1/4-20 UNC	.83	1.38	1.57	.63	.75	.24	.22	.81	CRA-1-8/1D-U-W3	
2D	2	M8	21	35	38	53	19	9	5,5	23,5	CRA-2-3D-M-W3	
3D	3	5/16-18 UNC	.83	1.38	1.50	2.09	.75	.35	.22	.93	CRA-2-3D-U-W3	
4D	4	M8	21	35	38	80	19	9	5,5	23,5	CRA-4-5D-M-W3	
5D	5	5/16-18 UNC	.83	1.38	1.50	3.15	.75	.3	.22	.93	CRA-4-5D-U-W3	

**Ordering Codes**

**Adaptor \*CRA-\*1-8/1D-\*M-\*W3**

- \* Channel Rail Adaptor **CRA**
- \* STAUFF Group 1D (DIN Group 1) **1-8/1D**
- 2D to 3D (DIN Group 2 to 3) **2-3D**
- 4D to 5D (DIN Group 4 to 5) **4-5D**
- \* Thread code Metric ISO thread **M**
- Unified coarse (UNC) thread **U**
- \* Material code Carbon Steel, zinc/nickel-plated **W3**
- Stainless Steel V4A **W5**
- 1.4401 / 1.4571 (AISI 316 / 316 Ti)

The Channel Rail Adaptor, type CRA 1-8/1D is also suitable for Standard Series, STAUFF Group 1 to 8.

All threaded parts are available with Metric ISO thread or unified coarse (UNC) thread according to dimension table. Alternative materials and surface finishings are available upon request. Contact STAUFF for further information.

**Compatibility with Channel Rails**

The STAUFF Channel Rail Adaptor, type CRA, is suitable for various channel rails, including the following types:

HALFEN	HILTI	UNISTRUT®	STAUFF (Cushion Clamp Series)
HM 41/41	MQ-21, MQ-41, MQ-52, MQ-72	P1000, P1000T, P1000V, P1000VT, P1001	SCS-048-1-PL, SCS-048-1-GR
HZA 41/22	MQ-21U, MQ-41U, MQ-72U	P2000, P2000T	SCS-120-1-PL, SCS-120-1-GR
HZM 41/41	MQ-21D, MQ-41D, MQ-52-72D	P3003, P3003T, P3300V, P3300VT, P3301	See page 149 for technical information.
HZM 41/22		P4000, P4000T	
HL 41/41, HL 41/B2		P5000, P5000T, P5001, P5500, P5500T, P5501	

Contact STAUFF to check compatibility with additional types of channel rails.

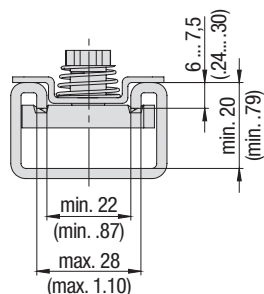

**Basic dimensional requirements for channel rails to be used with STAUFF Channel Rail Adaptors, type CRA**

Dimensional drawings: All dimensions in mm (in).



## Cover Plate Type GD

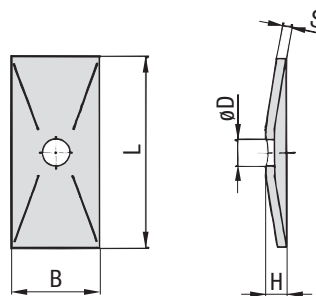

### Ordering Codes

#### Cover Plate

**\*GD-\*1D-\*W3**

* Cover Plate		<b>GD</b>
* STAUFF Group		<b>1D</b>
* Material code	Carbon Steel, zinc/nickel-plated	<b>W3</b>
	Stainless Steel V2A	<b>W4</b>
	1.4301 / 1.4305 (AISI 304 / 303)	<b>W4</b>
	Stainless Steel V4A	<b>W5</b>
	1.4401 / 1.4571 (AISI 316 / 316 Ti)	<b>W5</b>

Group STAUFF	DIN	Dimensions (mm/in)					Ordering Codes (Standard Options)
		L	B	H	S	ØD	
1D	1	34	30	7	3	7	GD-1D-W3
		1.34	1.18	.28	.12	.28	
2D	2	52	30	7	3	9	GD-2D-W3
		2.05	1.18	.28	.12	.35	
3D	3	65	30	7	3	9	GD-3D-W3
		2.56	1.18	.28	.12	.35	
4D	4	79	30	7	3	9	GD-4D-W3
		3.11	1.18	.28	.12	.35	
5D	5	102	30	7	3	9	GD-5D-W3
		4.02	1.18	.28	.12	.35	

Alternative materials and surface finishings are available upon request. Contact STAUFF for further information.

## Hexagon Head Bolt Type AS

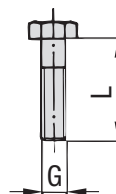

#### Hexagon Head Bolt AS

(according to DIN 931 / 933 or ANSI / ASME B18.2.1.)

Dimensions applicable only when used with Cover Plate GD

### Ordering Codes

#### Hexagon Head Bolt \*AS-\*M8x35-\*W3

* Type of bolt	Hexagon Head Bolt (according to DIN 931 / 933 or ANSI / ASME B18.2.1.)	<b>AS</b>
* Thread type and size acc. to dimension table	<b>M8x35</b>	
* Material code	Carbon Steel, zinc/nickel-plated	<b>W3</b>
	Stainless Steel V2A	<b>W4</b>
	1.4301 / 1.4305 (AISI 304 / 303)	<b>W4</b>
	Stainless Steel V4A	<b>W5</b>
	1.4401 / 1.4571 (AISI 316 / 316 Ti)	<b>W5</b>

Group STAUFF	DIN	Dimensions (mm/in)		Ordering Codes (Standard Options)
		Thread G x L		
1D	1	M6 x 35		AS-M6x35-W3
		1/4-20 UNC x 1-3/8		AS-1/4-20UNCx1-3/8-W3
2D	2	M8 x 35		AS-M8x35-W3
		5/16-18 UNC x 1-3/8		AS-5/16-18UNCx1-3/8-W3
3D	3	M8 x 45		AS-M8x45-W3
		5/16-18 UNC x 1-3/4		AS-5/16-18UNCx1-3/4-W3
4D	4	M8 x 50		AS-M8x50-W3
		5/16-18 UNC x 2		AS-5/16-18UNCx2-W3
5D	5	M8 x 60		AS-M8x60-W3
		5/16-18 UNC x 2-1/2		AS-5/16-18UNCx2-1/2-W3

All threaded parts are available with Metric ISO thread or unified coarse (UNC) thread according to dimension table. Alternative materials and surface finishings are available upon request. Contact STAUFF for further information.

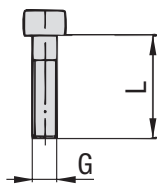

**Socket Cap Screw  
Type IS**

**Socket Cap Screw IS**  
(according to ISO 4762 or ANSI / ASME B18.3)  
Dimensions applicable only when used with Cover Plate GD



C

Group STAUFF	DIN	Dimensions (mm/in) Thread G x L	Ordering Codes (Standard Options)
1D	1	M6 x 35	IS-M6x35-W3
		1/4-20 UNC x 1-3/8	IS-1/4-20UNCx1-3/8-W3
2D	2	M8 x 35	IS-M8x35-W3
		5/16-18 UNC x 1-3/8	IS-5/16-18UNCx1-3/8-W3
3D	3	M8 x 45	IS-M8x45-W3
		5/16-18 UNC x 1-3/4	IS-5/16-18UNCx1-3/4-W3
4D	4	M8 x 50	IS-M8x50-W3
		5/16-18 UNC x 2	IS-5/16-18UNCx2-W3
5D	5	M8 x 60	IS-M8x60-W3
		5/16-18 UNC x 2-1/2	IS-5/16-18UNCx2-1/2-W3

**Ordering Codes**
**Hexagon Head Bolt \*IS-\*M8x35-\*W3**

* Type of bolt	Socket Cap Screw (according to ISO 4762 or ANSI / ASME B18.3)	<b>IS</b>
* Thread type and size acc. to dimension table	<b>M8x35</b>	
* Material code	Carbon Steel, zinc/nickel-plated	<b>W3</b>
	Stainless Steel V2A	<b>W4</b>
	1.4301 / 1.4305 (AISI 304 / 303)	
	Stainless Steel V4A	<b>W5</b>
	1.4401 / 1.4571 (AISI 316 / 316 Ti)	

All threaded parts are available with Metric ISO thread or unified coarse (UNC) thread according to dimension table.  
Alternative materials and surface finishings are available upon request. Contact STAUFF for further information.



### Safety Locking Plate

#### Type SI (for Use with Stacking Bolt AF)

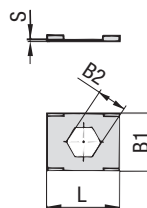

**Safety Locking Plate SI**  
(Prevents Stacking Bolt from Loosening)

#### Ordering Codes

#### Safety Locking Plate **\*SI-\*1D-\*W3**

- \* Safety Locking Plate **SI**
- \* STAUFF Group 1D (DIN Group 1) **1D**  
2D to 5D (DIN Group 2 to 5) **2-5D**
- \* Material code Carbon Steel, zinc/nickel-plated **W3**  
Stainless Steel V2A **W4**  
1.4301 / 1.4305 (AISI 304 / 303)  
Stainless Steel V4A **W5**  
1.4401 / 1.4571 (AISI 316 / 316 Ti)

Group STAUFF	DIN	Dimensions (mm/m)				Ordering Codes (Standard Options)
		L	B1	B2	S	
1D	1	27	22	11,2	0,5	SI-1D-W3
		1.06	.86	.44	.02	
2D	2	27	22	12,2	0,5	SI-2-5D-W3
3D	3					
4D	4					
5D	5	1.06	.86	.48	.02	

Alternative materials and surface finishings are available upon request. Contact STAUFF for further information.

### Safety Locking Plate

#### Type SIV (for Use with Stacking Bolt AF)

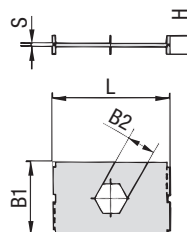

**Safety Locking Plate SIV**  
(Prevents Stacking Bolt from Loosening and Upper Clamp from Turning)

#### Ordering Codes

#### Safety Locking Plate **\*SIV-\*1D-\*W3**

- \* Safety Locking Plate **SIV**
- \* STAUFF Group 1D (DIN Group 1) **1D**  
2D to 3D (DIN Group 2 to 3) **2-3D**
- \* Material code Carbon Steel, zinc/nickel-plated **W3**  
Stainless Steel V4A **W5**  
1.4401 / 1.4571 (AISI 316 / 316 Ti)

Group STAUFF	DIN	Dimensions (mm/m)					Ordering Codes (Standard Options)
		L	B1	B2	S	H	
1D	1	27	28	11,1	1	7	SIV-1D-W3
		1.06	1.10	.44	.04	.27	
2D	2	45	28	12,1	1	7	SIV-2-3D-W3
3D	3						
		1.77	1.10	.48	.04	.27	

Alternative materials and surface finishings are available upon request. Contact STAUFF for further information.



**Stacking Bolt**  
(for Use with Safety Locking Plates SI / SIV) **Type AF**

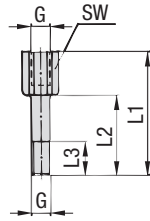

C

Group	STAUFF	DIN	Dimensions (mm/m)				Hex	Ordering Codes (Standard Options)
			Thread G	L1	L2	L3 min.		
1D	1	M6	34	20	12	11	AF-1D-M-W3	
		1/4-20 UNC	1.33	.78	.47	.43	AF-1D-U-W3	
2D	2	M8	33	20	12	12	AF-2D-M-W3	
		5/16-18 UNC	1.30	.78	.47	.47	AF-2D-U-W3	
3D	3	M8	44	29	12	12	AF-3D-M-W3	
		5/16-18 UNC	1.73	1.14	.47	.47	AF-3D-U-W3	
4D	4	M8	49	34	12	12	AF-4D-M-W3	
		5/16-18 UNC	1.92	1.33	.47	.47	AF-4D-U-W3	
5D	5	M8	61	46	12	12	AF-5D-M-W3	
		5/16-18 UNC	2.40	1.81	.47	.47	AF-5D-U-W3	

**Ordering Codes**

**Stacking Bolt**      **\*AF-\*1D-\*M-\*W3**

- \* Stacking Bolt      **AF**
- \* STAUFF Group      **1D**
- \* Thread code      Metric ISO thread      **M**  
Unified coarse (UNC) thread      **U**
- \* Material code      Carbon Steel, zinc/nickel-plated      **W3**  
Stainless Steel V2A      **W4**  
1.4301 / 1.4305 (AISI 304 / 303)  
Stainless Steel V4A      **W5**  
1.4401 / 1.4571 (AISI 316 / 316 Ti)

All threaded parts are available with Metric ISO thread or unified coarse (UNC) thread according to dimension table. Alternative materials and surface finishings are available upon request. Contact STAUFF for further information.





Please see page 63 with detailed order examples for some of the most popular Twin Series clamp assemblies.

C

### ① Type of Installation

Please select the type of installation (e.g. weld plates, rail nuts, etc.) and add the corresponding Code to position ① of the order code for your clamp assembly.

**Without Installation Equipment**  
Code: **none**

#### Installation on Weld Plate

**Single Weld Plate**  
Code: **SP**

**Group Weld Plate**  
Code: **RAP**

#### Installation on Mounting / Channel Rail

**Mounting Rail Nut**  
Code: **SM** (Carbon Steel)  
Code: **SMG** (Stainless Steel)

**Channel Rail Adaptor**  
Code: **CRA**

### ② Group Size & Diameters

Please select the required group size and diameter and add the corresponding Code to position ② of the order code for your clamp assembly.

Group	Outside Diameter	Availability of Clamp Body Materials & Designs		Code
		P / T / H	Type H	
1D (1)	6	●	●	106/06
	6,4	●	●	106.4/06.4
	8	●	●	108/08
	9,5	●	●	109.5/09.5
	10	●	●	110/10
	12	●	●	112/12
2D (2)	12,7	●	●	212.7/12.7
	13,5	●	●	213.5/13.5
	14	●	●	214/14
	15	●	●	215/15
	16	●	●	216/16
	17,2	●	●	217.2/17.2
3D (3)	18	●	●	218/18
	19	●	●	319/19
	20	●	●	320/20
	21,3	●	●	321.3/21.3
	22	●	●	322/22
	25	●	●	325/25
4D (4)	25,4	●	●	325.4/25.4
	26,9	●	●	426.9/26.9
	28	●	●	428/28
	30	●	●	430/30
	32	●	●	532/32
	33,7	●	●	533.7/33.7
5D (5)	35	●	●	535/35
	38	●	●	538/38
	40	●	●	540/40
	42	●	●	542/42

● Standard Option

### ③ Clamp Body Design & Material

Please select the design and material of your clamp body and add the corresponding Code to position ③ of the order code for your clamp assembly.

Please check the availability of the selected clamp body design and material according to the matrix table in ②.

#### Profiled Design

**Polypropylene**  
Code: **PP**

**Polypropylene (Colour: Black)**  
Code: **PP-BK**

**Polyamide**  
Code: **PA**

#### Type H (Smooth)

**Polypropylene**  
Code: **PP-H**

**Polypropylene (Colour: Black)**  
Code: **PP-H-BK**

**Polyamide**  
Code: **PA-H**

See pages 154 / 155 for material properties and technical information.

Please contact STAUFF for further details on fire-proof clamp body materials, tested and approved according to several international fire-protection standards.

### ④ Mounting & Fitting Combination

Please select the mounting and fitting combination (e.g. Bolts, Cover Plates, etc.) and add the corresponding Code to position ④ of the order code for your clamp assembly.

#### Installation with Cover Plate and Bolt

**Cover Plate GD with Hexagon Head Bolt AS**  
Code: **GD-AS**

**Cover Plate GD with Socket Cap Screw IS**  
Code: **GD-IS**

#### Installation with Locking Plate and Bolt

**Safety Locking Plate SI with Stacking Bolt AF**  
Code: **SI-AF**

**Safety Locking Plate SIV with Stacking Bolt AF**  
Code: **SIV-AF** (for STAUFF Group 1D to 3D only)

### ⑤ Thread Type

Please select the required thread type and add the corresponding Code to position ⑤ of the order code for your clamp assembly.

**Metric ISO thread**  
Code: **M**

**Unified coarse (UNC) thread**  
Code: **U**

All threaded parts are available with Metric ISO thread or unified coarse (UNC) thread according to dimension table.

### ⑥ Material & Surface Finishing

Please select the required material & surface finishing of the metal parts and add the corresponding Code to position ⑥ of the order code for your clamp assembly.

Metal parts made of Carbon Steel, zinc/nickel-plated **W3**

Metal parts made of Stainless Steel V2A 1.4301 / 1.4305 (AISI 304 / 303) **W4**

Metal parts made of Stainless Steel V4A 1.4401 / 1.4571 (AISI 316 / 316 Ti) **W5**

Weld Plate made of Carbon Steel, phosphated; Other metal parts made of Carbon Steel, zinc/nickel-plated **W10**

Individual combinations of alternative materials and surface finishings are available upon request. Contact STAUFF for further information.

### ⑦ Assembling & Kitting

If required, please select an additional assembling and kitting option and add the corresponding Code to the last position of the order code for your clamp assembly.

**Components supplied separately**  
Code: **none** (standard option)

**Components assembled**  
Code: **A** (special option)

**Components packed in kits**  
Code: **K** (special option)



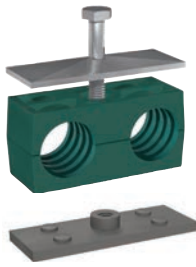

- 1x **Hexagon Head Bolt**  
Surface: W3  
Thread: Metric
- 1x **Cover Plate**  
Surface: W3
- 1x **Clamp Body** (two halves)  
STAUFF Group 1D (DIN 1)  
both O.D. 6 mm / .24 in  
Material: Polypropylene  
Profiled inside surface  
with tension clearance
- 1x **Weld Plate**  
Surface: W2  
Thread: Metric

**Order Code**

**SP-106/06-PP-GD-AS-M-W10**

W10 is the standard option for this type of installation.



- 1x **Hexagon Head Bolt**  
Surface: W3  
Thread: Metric
- 1x **Cover Plate**  
Surface: W3
- 1x **Clamp Body** (two halves)  
STAUFF Group 1D (DIN 1)  
both O.D. 6 mm / .24 in  
Material: Polypropylene  
Profiled inside surface  
with tension clearance

**Order Code**

**106/06-PP-GD-AS-M-W3**

W3 is the standard option for this type of installation.



- 1x **Stacking Bolt**  
Surface: W3  
Thread: Metric
- 1x **Safety Locking Plate (Type SI)**  
Surface: W3  
Thread: Metric
- 1x **Clamp Body** (two halves)  
STAUFF Group 1D (DIN 1)  
both O.D. 6 mm / .24 in  
Material: Polypropylene  
Profiled inside surface  
with tension clearance

**Order Code**

**106/06-PP-SI-AF-M-W3**

W3 is the standard option for this type of installation.



- 1x **Stacking Bolt**  
Surface: W3  
Thread: Metric
- 1x **Safety Locking Plate (Type SIV)**  
Surface: W3  
Thread: Metric
- 1x **Clamp Body** (two halves)  
STAUFF Group 1D (DIN 1)  
both O.D. 6 mm / .24 in  
Material: Polypropylene  
Profiled inside surface  
with tension clearance

**Order Code**

**106/06-PP-SIV-AF-M-W3**

W3 is the standard option for this type of installation.  
This type of installation is available up to STAUFF Group 3D only.



- 1x **Hexagon Head Bolt**  
Surface: W3  
Thread: Metric
- 1x **Cover Plate**  
Surface: W3
- 1x **Clamp Body** (two halves)  
STAUFF Group 1D (DIN 1)  
both O.D. 6 mm / .24 in  
Material: Polypropylene  
Profiled inside surface  
with tension clearance
- 1x **Hexagon Rail Nut**  
Surface: W3  
Thread: Metric

**Order Code** (Mounting Rail TS not included.)

**SM-106/06-PP-GD-AS-M-W3**

W3 is the standard option for this type of installation.

**Thread Codes**

All threaded parts are available with Metric ISO thread or unified coarse (UNC) thread according to dimension table.

Metric ISO thread	<b>M</b>
Unified coarse (UNC) thread	<b>U</b>

**Material Codes**









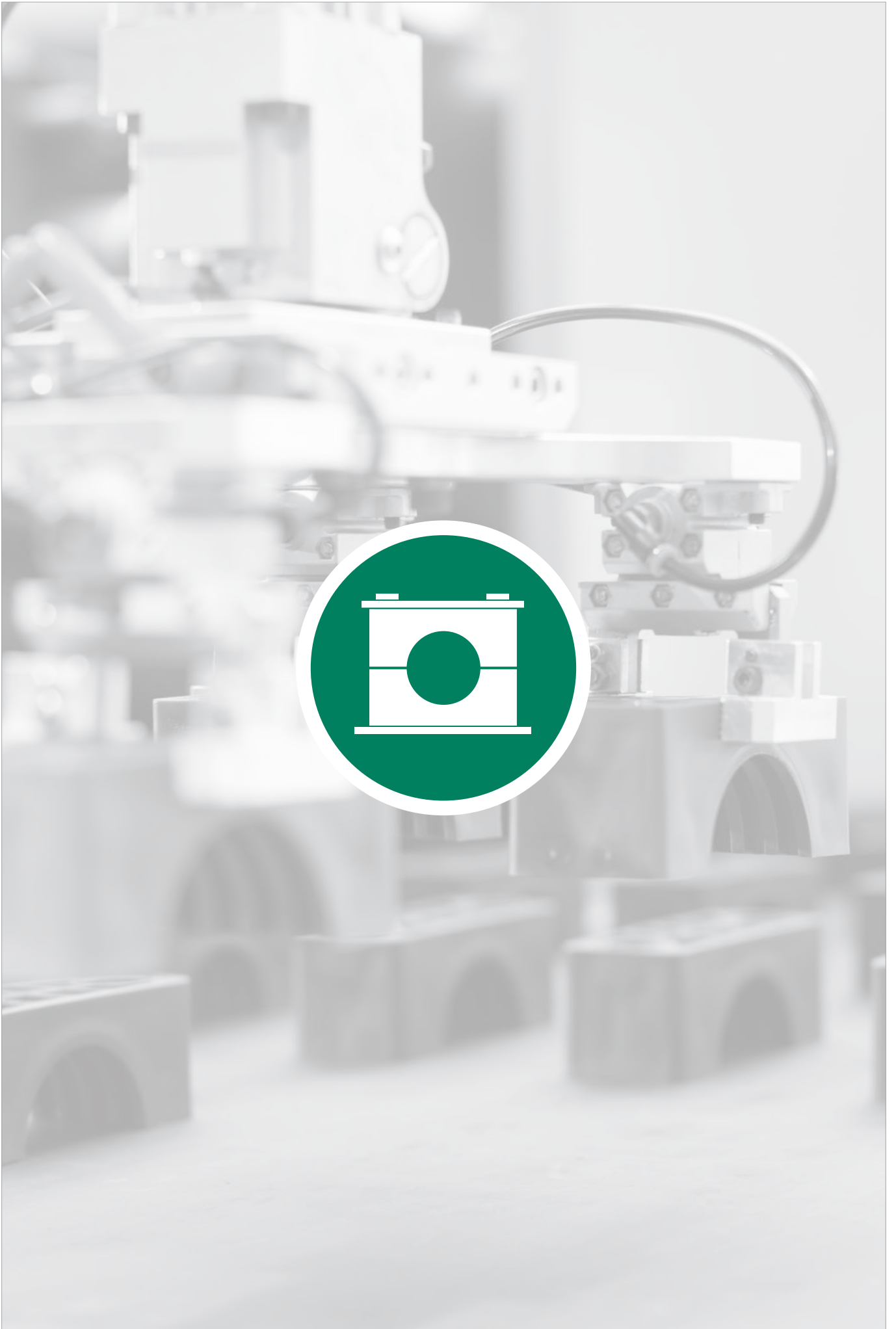

The below listed material codes describe the materials and surface finishings of metal parts that are most relevant for Twin Series clamp assemblies. Individual combinations of alternative materials and surface finishings are available upon request. Contact STAUFF for further information.

Metal parts made of Carbon Steel, zinc/nickel-plated	<b>W3</b>
Metal parts made of Stainless Steel V2A: 1.4301 / 1.4305 (AISI 304 / 303)	<b>W4</b>
Metal parts made of Stainless Steel V4A: 1.4401 / 1.4571 (AISI 316 / 316 Ti)	<b>W5</b>
Weld Plate made of Carbon Steel, phosphated	<b>W10</b>
Other metal parts made of Carbon Steel, zinc/nickel-plated	<b>W10</b>

**C**





	<b>Clamp Body</b> Profiled Inside Surface with Tension Clearance	66
	<b>Clamp Body with Elastomer Inserts</b>	66
	<b>Weld Plate</b> SPAD	67
	<b>Cover Plate</b> DPAD	67
	<b>Hexagon Head Bolt</b> AS	68
	<b>Mounting Rail Nut</b> GMV	68
	<b>Mounting Rail</b> STSV	68
	<b>Channel Rail Adaptor</b> CRA	68
	<b>Socket Cap Screw</b> IS	68
	<b>Safety Locking Plate</b> SIP	68
	<b>Stacking Bolt</b> AF	68
	<b>Clamp Assemblies</b>	69

**D**

### Clamp Body - Profiled Design

Profiled Inside Surface with Tension Clearance

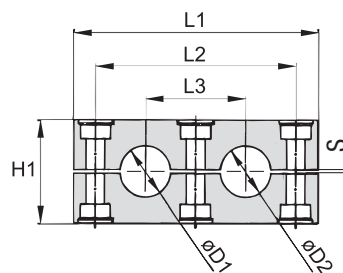
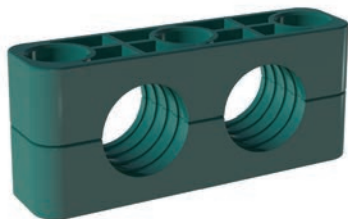

D

#### Ordering Codes

**Clamp Body** \*4\*012.7/12.7-\*PP

One clamp body is consisting of two clamp halves.

- \* 1<sup>st</sup> part of STAUFF Group **4**
- \* Exact outside diameters Ø D1 / Ø D2 (mm) **012.7/12.7**
- \* Material code (see below) **PP**

#### Standard Materials



**Polypropylene**  
Colour: Green  
Material code: **PP**



**Polyamide**  
Colour: Black  
Material code: **PA**

See pages 154 / 155 for material properties and technical information.

Group	Outside Diameter Pipe / Tube Ø D1 / Ø D2		Nominal Bore Pipe (in)	Copper Tube ASTM B88 (in)	Ordering Codes (2 Clamp Halves) (** = Material)	Dimensions (mm/in)					
	(mm)	(in)				L1	L2	L3	H1	S	Width
4S-D	12,7	1/2		3/8	4012.7/12.7-**	115 4.53	90 3.54	45 1.77	48 1.89	1,2 .05	30 1.18
	19	3/4			4019/19-**						
	20				4020/20-**						
	21,3		1/2		4021.3/21.3-**						
	22			3/4	4022/22-**						
	25,4	1			4025.4/25.4-**						
5S-D	26,9		3/4		4026.9/26.9-**	145 5.71	120 4.72	60 2.36	60 2.36	2,0 .08	30 1.18
	32	1-1/4			5032/32-**						
	33,7		1		5033.7/33.7-**						
	38	1-1/2			5038/38-**						
	42		1-1/4		5042/42-**						

Additional outside diameters and Clamp Bodies, type H (smooth inside surface without tension clearance) are available upon request. Please contact STAUFF for further information.

### Clamp Body with Elastomer Inserts Type RI

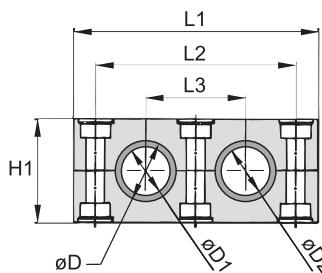

For use with Elastomer Inserts of the Heavy Series, STAUFF Group 4S and 5S (see page 39 for details)

#### Ordering Codes

**Clamp Assembly** \*4\*006/06-\*PP-R

One assembly is consisting of one clamp body and two inserts.

- \* 1<sup>st</sup> part of STAUFF Group **4**
- \* Exact outside diameters Ø D1 / Ø D2 (mm) **006/06**
- \* Material code (see below) **PP-R**

#### Standard Materials



**Polypropylene**  
Colour: Black  
Material code: **PP-R**



**Polyamide**  
Colour: Black  
Material code: **PA-R**



**Elastomer Inserts**  
**Thermoplastic Elastomer (73 Shore-A)**  
Colour: Black

Group	Outside Diameter Pipe / Tube / Hose Ø D1 / Ø D2		Ordering Codes (Clamp Assembly) (**R = Material)	Dimensions (mm/in)					
	(mm)	(in)		Ø D	L1	L2	L3	H1	Width
4S-D	6		4006/06-**R	25 .98	115 4.53	90 3.54	45 1.77	48 1.89	30 1.18
	8	5/16	4008/08-**R						
	10		4010/10-**R						
	12		4012/12-**R						
	12,7	1/2	4012.7/12.7-**R						
	14		4014/14-**R						
	15		4015/15-**R						
	16	5/8	4016/16-**R						
	17,2		4017.2/17.2-**R						
	18		4018/18-**R						
	19	3/4	4019/19-**R						
5S-D	20		5020/20-**R	38 1.50	145 5.71	120 4.72	60 2.36	60 2.36	30 1.18
	21,3		5021.3/21.3-**R						
	22	7/8	5022/22-**R						
	25		5025/25-**R						
	26,9		5026.9/26.9-**R						
	28		5028/28-**R						
	30		5030/30-**R						
	32	1-1/4	5032/32-**R						

See pages 154 / 155 for properties and technical information. Additional outside diameters are available upon request. Please contact STAUFF for further information.

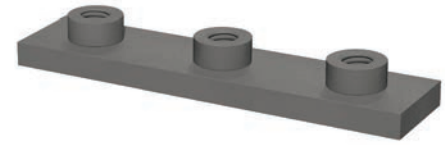
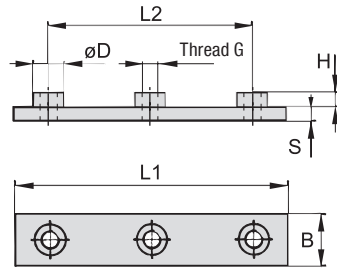

**Weld Plate  
Type SPAD**

Group STAUFF	Dimensions (mm/in)		B	S	H	Thread G	ØD	Ordering Codes (Standard Options)
	L1	L2						
4S-D	130	90	30	8	8,5	M10	18	SPAD-4S-M-W1
	5.12	3.54	1.18	.31	.33	3/8-16 UNC	.71	SPAD-4S-U-W2*
5S-D	160	120	30	8	8,5	M10	18	SPAD-5S-M-W1
	6.30	4.72	1.18	.31	.33	3/8-16 UNC	.71	SPAD-5S-U-W2*

All threaded parts are available with Metric ISO thread or unified Coarse (UNC) thread according to dimension table. Alternative materials and surface finishings are available upon request. Contact STAUFF for further information.

\* Standard finishing option in North America is W2 (Carbon Steel, phosphated).

**Ordering Codes**
**Weld Plate**
**\*SPAD-\*4S-\*M-\*W1**

* Weld Plate		<b>SPAD</b>
* STAUFF Group	4S-D 5S-D	<b>4S</b> <b>5S</b>
* Thread code	Metric ISO thread Unified coarse (UNC) thread	<b>M</b> <b>U</b>
* Material code	Carbon Steel, uncoated Carbon Steel, phosphated Carbon Steel, zinc/nickel-plated  Stainless Steel V2A 1.4301 / 1.4305 (AISI 304 / 303) Stainless Steel V4A 1.4401 / 1.4571 (AISI 316 / 316 Ti)	<b>W1</b> <b>W2</b> <b>W3</b>  <b>W4</b> <b>W5</b>

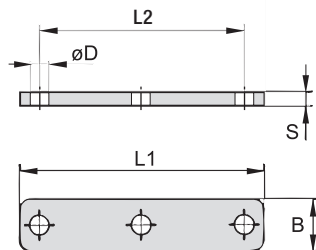
**D**
**Cover Plate  
Type DPAD**

Group STAUFF	Dimensions (mm/in)		B	S	ØD	Ordering Codes (Standard Options)
	L1	L2				
4S	115	90	30	8	11	DPAD-4S-W1*
	4.53	3.54	1.18	.31	.43	
5S	145	120	30	8	11	DPAD-5S-W1*
	5.71	4.72	1.18	.31	.43	

All threaded parts are available with Metric ISO thread or unified Coarse (UNC) thread according to dimension table. Alternative materials and surface finishings are available upon request. Contact STAUFF for further information.

\* Standard finishing option in North America is W3 (Carbon Steel, phosphated).

**Ordering Codes**
**Cover Plate**
**\*DPAD-\*4S-\*W1**

* Cover Plate		<b>DPAD</b>
* STAUFF Group	4S-D 5S-D	<b>4S</b> <b>5S</b>
* Material code	Carbon Steel, uncoated Carbon Steel, phosphated Carbon Steel, zinc/nickel-plated  Stainless Steel V2A 1.4301 / 1.4305 (AISI 304 / 303) Stainless Steel V4A 1.4401 / 1.4571 (AISI 316 / 316 Ti)	<b>W1</b> <b>W2</b> <b>W3</b>  <b>W4</b> <b>W5</b>



## Hexagon Head Bolt Type AS

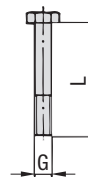

**Hexagon Head Bolt AS**

(according to DIN 931 / 933 or ANSI / ASME B18.2.1.)  
Dimensions applicable only when used with Cover Plate DPAD

D

### Ordering Codes

#### Hexagon Head Bolt \*AS-\*M10x70-\*W1

* Type of bolt	Hexagon Head Bolt (according to DIN 931 / 933 or ANSI / ASME B18.2.1.)	<b>AS</b>
* Thread type and size acc. to dimension table	<b>M10x70</b>	
* Material code	Carbon Steel, uncoated	<b>W1</b>
	Carbon Steel, zinc/nickel-plated	<b>W3</b>
	Stainless Steel V2A 1.4301 / 1.4305 (AISI 304 / 303)	<b>W4</b>
	Stainless Steel V4A 1.4401 / 1.4571 (AISI 316 / 316 Ti)	<b>W5</b>

Group STAUFF	DIN	Dimensions (mm/in) Thread G x L	Ordering Codes (Standard Options)
4S	2	M10 x 60	AS-M10x60-W1
		3/8-16 UNC x 2-1/4	AS-3/8-16UNCx2-1/4-W3*
5S	3	M10 x 70	AS-M10x70-W1
		3/8-16 UNC x 2-3/4	AS-3/8-16UNCx2-3/4-W3*

All threaded parts are available with Metric ISO thread or unified coarse (UNC) thread according to dimension table. Alternative materials and surface finishings are available upon request. Contact STAUFF for further information.

If required, use Safety Washers, type SI as locking devices to prevent Hexagon Head Bolts, type AS from loosening. See page 46 for details.

\* Standard finishing option in North America is W3 (Carbon Steel, zinc/nickel-plated).

## Further Metal Hardware

For Use with the Heavy Twin Series



**Mounting Rail Nut  
Type GMV**

Heavy Series, STAUFF Group 4S and 5S  
(See page 42 for details)



**Mounting Rail  
Type STSV**

Heavy Series  
(See page 42 for details)



**Channel Rail Adaptor  
Type CRA**

Heavy Series, STAUFF Group 4S and 5S  
(See page 43 for details)



**Socket Cap Screw  
Type IS**

Heavy Series, STAUFF Group 4S and 5S  
(See page 45 for details)

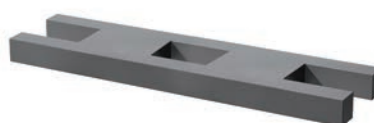

**Safety Locking Plate  
Type SIPD**

Heavy Twin Series, STAUFF Group 4S-D and 5S-D  
(Contact STAUFF for details)



**Stacking Bolt  
Type AF**

Heavy Series, STAUFF Group 4S and 5S  
(See page 47 for details)





### ① Type of Installation

Please select the type of installation (e.g. Weld Plates, Rail Nuts etc.) and add the corresponding **Code** to position ① of the order code for your clamp assembly.

**Without Installation Equipment**  
Code: **none**

#### Installation on Weld Plate

**Single Weld Plate**  
Code: **SPAD**

#### Installation on Mounting / Channel Rail

**Mounting Rail Nut**  
Code: **GMV**

**Channel Rail Adaptor**  
Code: **CRA**

### ② Group Size & Diameters

Please select the required group size and diameter and add the corresponding **Code** to position ② of the order code for your clamp assembly.

Group	Outside Diameter P / T / H (mm)	Availability of Clamp Body Materials & Designs		Code
		Profiled Design	Type RI	
4S-D	6	○	●	4006/06
	8	○	●	4008/08
	10	○	●	4010/10
	12	○	●	4012/12
	12.7	●	●	4012.7/12.7
	14	○	●	4014/14
	15	○	●	4015/15
	16	○	●	4016/16
	17.2	○	●	4017.2/17.2
	18	○	●	4018/18
	19	●	●	4019/19
	20	●	○	4020/20
	21.3	●	○	4021.3/21.3
	22	●	○	4022/22
25.4	●	○	4025.4/25.4	
26.9	●	○	4026.9/26.9	
5S-D	20	○	●	5020/20
	21.3	○	●	5021.3/21.3
	22	○	●	5022/22
	25	○	●	5025/25
	26.9	○	●	5026.9/26.9
	28	○	●	5028/28
	30	○	●	5030/30
	32	●	●	5032/32
	33.7	●	○	5033.7/33.7
	38	●	○	5038/38
42	●	○	5042/42	

● Standard Option

### ③ Clamp Body Design & Material

Please select the design and material of your clamp body and add the corresponding **Code** to position ③ of the order code for your clamp assembly.

Please check the availability of the selected clamp body design and material according to the matrix table in ②.

#### Profiled Design

**Polypropylene**  
Code: **PP**

**Polyamide**  
Code: **PA**

#### Type RI (with Elastomer Insert)

**Polypropylene**  
Code: **PP-R**

**Polyamide**  
Code: **PA-R**

Clamp Bodies, Type H (smooth Inside surface without tension clearance) are available upon request. Please contact STAUFF for further information.

### ④ Mounting & Fitting Combination

Please select the mounting and fitting combination (e.g. Bolts, Cover Plates etc.) and add the corresponding **Code** to position ④ of the order code for your clamp assembly.

#### Installation with Cover Plate and Bolts

**Cover Plate DPAD with Hexagon Head Bolt AS**  
Code: **DPAD-AS**

#### Installation with Locking Plate and Bolts

**Safety Locking Plate SIPD with Stacking Bolt AF**  
Code: **SIPD-AF**

### ⑤ Thread Type

Please select the required thread type and add the corresponding **Code** to position ⑤ of the order code for your clamp assembly.

**Metric ISO thread**  
Code: **M**

**Unified coarse (UNC) thread**  
Code: **U**

All threaded parts are available with Metric ISO thread or unified coarse (UNC) thread according to dimension table.

### ⑥ Material & Surface Finishing

Please select the required material & surface finishing of the metal parts and add the corresponding **Code** to position ⑥ of the order code for your clamp assembly.

Metal parts made of Carbon Steel, uncoated **W1**

Metal parts made of Carbon Steel, phosphated **W2**

Metal parts made of Carbon Steel, zinc/nickel-plated **W3**

Metal parts made of Stainless Steel V2A 1.4301 / 1.4305 (AISI 304 / 303) **W4**

Metal parts made of Stainless Steel V4A 1.4401 / 1.4571 (AISI 316 / 316 Ti) **W5**

Weld Plate made of Carbon Steel, phosphated; Other metal parts made of Carbon Steel, zinc/nickel-plated **W10**

Weld Plate and Cover Plate made of Carbon Steel, phosphated; Bolts made of Carbon Steel, uncoated **W12**

Mounting Rail Nuts made of Carbon Steel, zinc/nickel-plated; Cover Plate made of Carbon Steel, phosphated; Bolts made of Carbon Steel, uncoated **W13**

Weld Plate / Cover Plate made of Carbon Steel, phosphated; Bolts made of Carbon Steel, zinc/nickel-plated **W15**

Mounting Rail Nuts made of Carbon Steel, zinc/nickel-plated; Cover Plate made of Carbon Steel, phosphated; Bolts made of Carbon Steel, zinc/nickel-plated **W16**

Safety Locking Plate made of Carbon Steel, phosphated; Bolts made of Carbon Steel, zinc/nickel-plated **W17**

Safety Locking Plate made of Carbon Steel, uncoated; Bolts made of Carbon Steel, phosphated **W18**

Cover Plate made of Carbon Steel, phosphated; Bolts made of Carbon Steel, uncoated **W19**

Individual combinations of alternative materials and surface finishings are available upon request. Contact STAUFF for further information.

### ⑦ Assembling & Kitting

If required, please select an additional assembling and kitting option and add the corresponding **Code** to the last position of the order code for your clamp assembly.



**Components Supplied Separately**  
Code: **none** (Standard Option)

**Components Assembled**  
Code: **A** (Special Option)

**Components Packed in Kits**  
Code: **K** (Special Option)

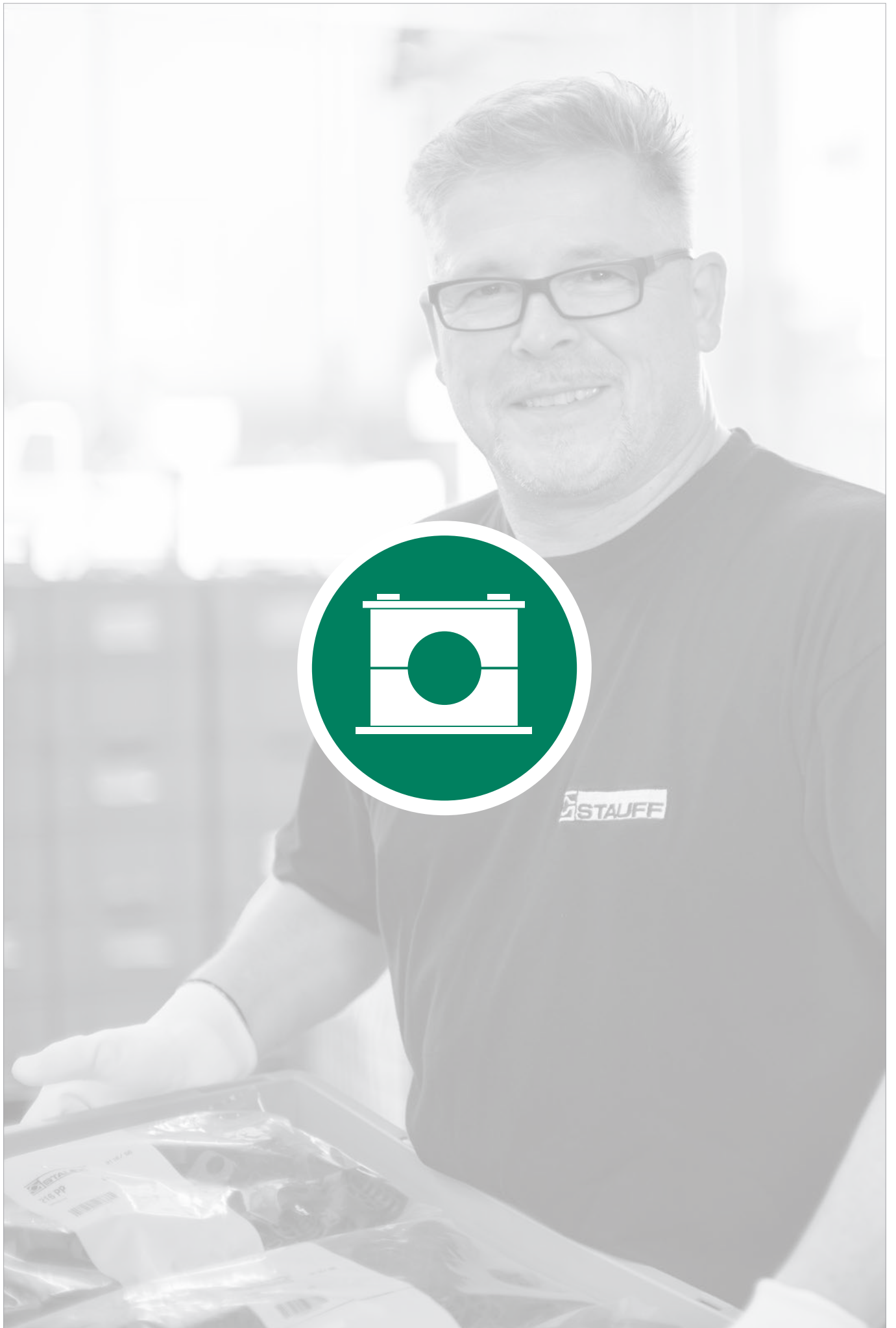



	<b>Introduction</b>	<b>72</b>
	<b>Standard Series</b>	<b>74-81</b>
	<b>ACT Clamp Body</b>	<b>74</b>
	<b>Installation on Weld Plates</b>	<b>75</b>
	<b>Multi-Level Installation (with Weld Plate)</b>	<b>76</b>
	<b>Installation with Channel Rail Adaptors</b>	<b>77</b>
	<b>Installation in Field Trays / Cable Ladders</b>	<b>78</b>
	<b>Multi-Level Installation (with Stacking &amp; Hammerhead Bolts)</b>	<b>79</b>
	<b>Multi-Level Installation in Field Trays / Cable Ladders (with Hammerhead Bolts)</b>	<b>80</b>
	<b>Clamp Assemblies</b>	<b>81</b>
	<b>Twin Series</b>	<b>82-89</b>
	<b>ACT Clamp Body</b>	<b>82</b>
	<b>Installation on Weld Plates</b>	<b>83</b>
	<b>Multi-Level Installation (with Weld Plate)</b>	<b>84</b>
	<b>Installation with Channel Rail Adaptors</b>	<b>85</b>
	<b>Installation in Field Trays / Cable Ladders</b>	<b>86</b>
	<b>Multi-Level Installation (with Stacking &amp; Hammerhead Bolts)</b>	<b>87</b>
	<b>Multi-Level Installation in Field Trays / Cable Ladders (with Hammerhead Bolts)</b>	<b>88</b>
	<b>Clamp Assemblies</b>	<b>89</b>



**STAUFF ACT**  
Anti-Corrosion Technology

E



Crevice corrosion formed under a regular plastic clamp



Crevice corrosion formed under a regular plastic clamp

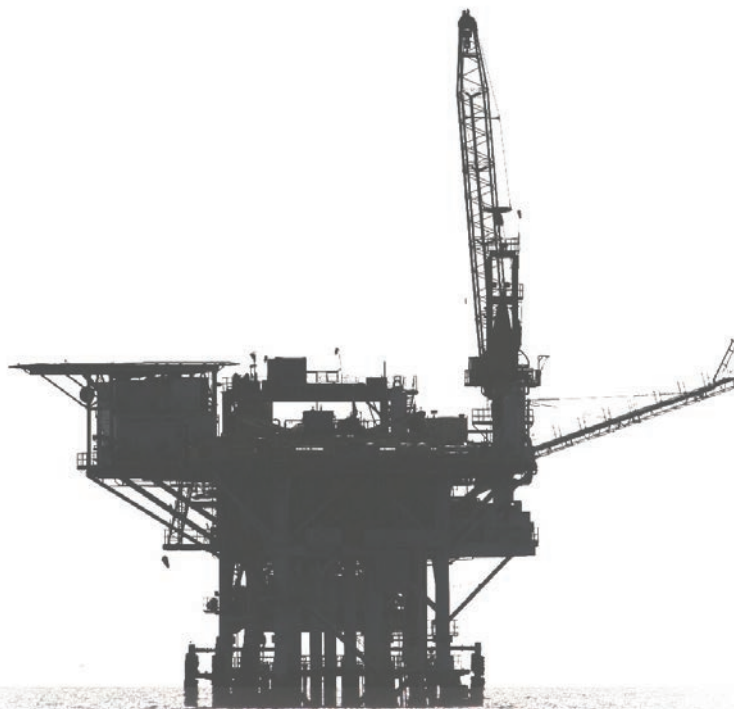

**Stainless Steel Pipework**

Stainless steel pipework on oil and gas platform and processing plants (that are located offshore and up to 50 km inland) is used over a wide range of temperature, flow and pressure conditions, e.g. for process instrumentation and sensing, as well as for chemical inhibition, hydraulic or utility lines.

The typical tubing material selected for these particular applications is AISI 316 stainless steel, although in more recent times other tube materials have been utilized to try and counteract the offshore corrosion issue.

In all major offshore oil and gas regions – including the Gulf of Mexico, the North Sea, the Gulf of Guinea and the China Sea – corrosion of AISI 316 stainless steel pipework can be observed, and has been a researched and well documented problem as well as a costly and time consuming issue with regard to maintenance processes for many years.

**Pitting Corrosion**

One of the most prevalent forms of localised corrosion is pitting corrosion: Under certain specific conditions – particularly involving chlorides (such as sodium chloride in seawater) and exacerbated by elevated temperatures – small pits can form in a stainless steel surface.

Dependent upon both the environment and the stainless steel itself, these pits may continue to grow and eventually lead to perforation of tubing walls and leaks, while the majority of the surface may still be totally unaffected.

Pitting corrosion is often quite easy to recognise: small individual pits and – in later stages – sometimes deeper and connected pits can be observed by visual inspection with the unaided eye.

**Crevice Corrosion**

Another dominant type is crevice corrosion, which is a lot more difficult to observe: It usually tends to occur in shielded areas such as crevices, formed under gaskets, washers, fastener heads, insulating material, surface deposits, disbanded coatings, threads and lap joints.

Pipe clamps made of plastic in particular have also been prone to inducing crevice corrosion in the past, because the plastic deforms around the tubing and creates even tighter crevices.

Crevice corrosion is always initiated by changes in the local chemistry within the shielded area, usually associated with a stagnant solution on the micro-environmental level:

- Trapped seawater becomes stagnant
- Depletion of inhibitor and oxygen
- A shift to acid conditions
- Build-up of aggressive ion species (such as sodium chloride in seawater)
- Accelerated corrosion process

Crevice corrosion can have serious and adverse consequences eventually leading to perforation of tubing walls and the escape of highly flammable and hazardous fluids and chemicals.

**Material Selection**

Hence, the selection of proper materials and the use of robust design and safe construction practices are mandatory, even if crevices are sometimes difficult or even impossible to avoid in tubing installations when using regular types of tubing supports and clamps.

This is where STAUFF ACT Clamps come into play ...

**Corrosion Facts**

Corrosion in general is a naturally occurring phenomenon commonly defined as the deterioration of a substance (usually a metal) or its properties because of a reaction with its environment. Like other natural hazards, corrosion can cause not only expensive but also dangerous damage to almost everything from automobiles, home appliances and drinking water systems to pipelines, bridges and public buildings.

Figures provided by the U.S. National Climatic Data Center underline that major weather related disasters the U.S. incurred total losses of averaging USD 17 billion annually (1980 – 2001). According to U.S. corrosion studies, the estimated direct cost of metallic corrosion in general was USD 276 billion on an annual basis in 1998. This represented 3,1% of the U.S. Gross Domestic Product.

Direct corrosion costs associated with the domestic oil and gas production activities in the U.S. were determined to be about USD 1,4 billion annually, with USD 0,6 billion attributed to surface piping and facility costs, USD 0,5 billion to downhole tubing, and USD 0,3 billion to capital expenditures related to corrosion.

The U.S. refineries represent approximately 23% of the world's petroleum production in 1996 supplying more than 18 million barrels of refined petroleum products per day, with a total corrosion related direct cost of USD 3,7 billion. Maintenance expenses make up USD 1,8 billion of this total, vessel expenses are USD 1,4 billion and fouling costs are approximately USD 0,5 billion annually.

*Source of Information:* Report No. FHWA-RD-01-156, September 2001 **Corrosion Costs and Preventive Strategies in the United States** Report by CC Technologies Laboratories, Inc. to Federal Highway Administration Office of Infrastructure Research and Development



Technology protected  
 by utility model patent

## Main Features

Efficient Prevention of Crevice Corrosion under Pipe Clamps on Stainless Steel Pipework  
 Middle- and Long-Term Cost Savings due to Extended Service and Maintenance Intervals

### Construction based on STAUFF Clamps

- Design based on Original STAUFF Clamps according to DIN 3015, Parts 1 and 3 (Standard Series and Twin Series), the tried and tested industry standard for several decades
- Covering the most commonly used metric and imperial pipe diameters from 6 mm to 42 mm (from 1/4 inch to 1 1/2 inch)
- Alternative configurations and pipe diameters on request
- Installation time reduction (compared to alternative designs)

### Independent Testing and Approval

- Subject to stringent testing at the STAUFF in-house laboratories located in Werdohl (Germany)
- Salt spray tests according to ASTM B117 applied in controlled laboratory environments
- Long-term field tested on a rig in the Dutch sector of the North Sea
- Tests results independently assessed by Centre for Corrosion Technology at Sheffield Hallam University
- Fully detailed, independent test reports available on request

### Innovative Design and Materials

- Material and design in compliance with section 7.3 (Tubing Installation) of the Norwegian offshore standard Norsok Z-010 (Revision 3, published in October 2000), API RP 552 and NACE SP 0108-2008 (section 13)
- ① Clamp body made of flame-retardant PP-V0 plastic material; tested and V0 classified according to UL 94
- ② Integrated ACE anti-corrosion elastomer strips avoid the accumulation of seawater between clamp body and pipe
- ③ Drainage channels aid the dispersal of seawater (self-draining)

- ④ ACT Mounting Hardware is made of Stainless Steel V4A (Material Code: W55) with enhanced corrosion resistance by practically excluding metallic and non-metallic impurities during production, processing and handling (delivered in hermetically-sealed quality storage bags with 25 pieces each to avoid contamination during transport)
- High UV stability of the clamp body material; resistant against seawater, rain and oil
- Suitable for continuous exposure to temperatures from -25 °C to +80 °C (from -13 °F to +176 °F)
- To be used in sub-sea and top-side environments; alleviating the requirement for two different products



Salt-spray testing of ACT Mounting Hardware (above of the picture) compared to contaminated hardware made of Stainless Steel V4A (below of the picture)

## Design

STAUFF ACT Clamps are an innovatively designed solution for the installation of instrumentation pipework where anti-corrosion properties are of paramount importance (e.g. in the fields of offshore oil and gas exploration and processing).

The design – based on the tried and tested STAUFF Clamps according to DIN 3015 – offers installation time reduction and long term cost savings due to extended service intervals.

The STAUFF ACT clamp body design is available for the Standard Series (DIN 3015, Part 1) and the Twin Series (DIN 3015, Part 3) to cover the most commonly used metric and imperial pipe diameters from 6 mm to 42 mm (1/4 inch to 1 1/2 inch).

## Development

Throughout their development, STAUFF ACT Clamps have been subject to stringent testing at the STAUFF in-house laboratories located in Werdohl, Germany.

In order to ensure credibility of the product, the development process has also involved independent testing.

In a controlled laboratory environment, continuous hot salt spray tests according to ASTM B117 have been applied for periods of 2000 hours to various clamp configurations holding AISI 316 stainless steel tubing.

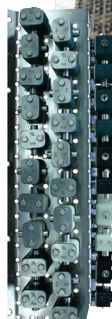

In addition to that, independent field test samples – located on an oil rig in the Dutch sector of the North Sea – have also been assessed at the Sheffield Hallam University facilities.

Both independent tests have recorded positive results in favour of the anti-corrosion attributes of the STAUFF ACT Clamp. Fully detailed test reports are available upon request.



To achieve this, the services of the Centre for Corrosion Technology at Sheffield Hallam University's Materials and Engineering Research Institute have been utilized, applying advanced techniques with equipment such as high resolution surface metrology and form measurement systems.

## Conformity

Using flame-retardant PP-V0 plastic material for the clamp body and ACE anti-corrosion elastomer material for the rubber strips, STAUFF ACT Clamps have been constructed in compliance with section 7.3 (Tubing Installation) of the Norwegian offshore standard Norsok Z-010 (Revision 3, published in October 2000). They also comply with Norsok I-001 (Revision 4, published in January 2010), API RP 552 and NACE SP 0108-2008 (section 13).

## The Norsok Organisation



Norsok is a Norwegian industry initiative to add value, reduce cost and lead time and remove unnecessary activities in offshore field developments and operations.

The Norsok standards are developed by the Norwegian petroleum industry and are jointly issued by the Norwegian Oil Industry Association (OLF) and the Federation of Norwegian Engineering Industries (TBL). They are administered by the Norwegian Technology Standards Institution (NTS).

The purpose of the Norsok industry standards is to replace the individual oil company specifications for use in existing and future petroleum industry developments, subject to the individual company's review and application.



Standard Series according to DIN 3015, Part 1  
**ACT Clamp Body**

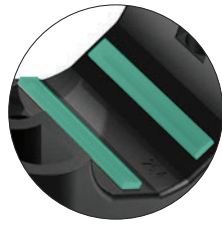

Integrated Rubber Strips  
 made of Anti-Corrosion Elastomer (ACE)

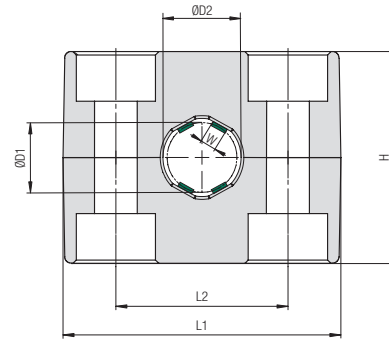

**Ordering Codes**

**Clamp Body** \*2-\*12.7-\*ACT  
 Clamp Body, STAUFF Group 1A \*1-\*06.4A-\*ACT

One clamp body consists of two identical clamp halves, each with two integrated rubber strips.

- \* STAUFF Group **2**
- \* Exact outside diameter Ø D1 (mm) **12.7**
- \* Material code **ACT**

Group Size		Outside Diameter Ø D1		Ordering Code	Packaging Unit	Dimensions (mm/in)					
STAUFF	DIN	(mm)	(in)	(2 Clamp Halves)	(in pieces / bag)	ØD2	W	L1	L2	H	Width
1A	1	6		106A-ACT	25	9	1,4	37	20	26	30
		6,4	1/4	106.4A-ACT	25	9,4	1,5				
		8		108A-ACT	25	11,0	1,8				
		9,5	3/8	109.5A-ACT	25	12,5	2,2				
		10		110A-ACT	25	13	2,3				
		12		112A-ACT	25	15	2,8				
2	2	12,7	1/2	212.7-ACT	25	15,7	3,5	42	26	32	30
		14		214-ACT	25	17	3,5				
		14,3	9/16	214.3-ACT	25	17,3	3,5				
		15		215-ACT	25	18	3,5				
		16	5/8	216-ACT	25	19	3,5				
		18		218-ACT	25	21	3,5				
3	3	19	3/4	319-ACT	25	22	3,5	50	33	35,5	30
		20		320-ACT	25	23	3,5				
		21,3		321.3-ACT	25	24,3	3,5				
		25		325-ACT	25	28	3,5				
		25,4	1	325.4-ACT	25	28,4	3,5				
4	4	26,9		426.9-ACT	25	31,1	6,0	59	40	42	30
		28		428-ACT	25	32,2	6,0				
		30		430-ACT	25	34,2	6,0				
5	5	32	1 1/4	532-ACT	25	36,2	7	71	52	58	30
		35		535-ACT	25	39,2	7				
		38	1 1/2	538-ACT	25	42,2	8				
		42		542-ACT	25	46,2	8				

Additional sizes and outside diameters are available upon request.  
 Please contact STAUFF for further information.





### ACT Mounting Hardware Installation on Single Weld Plates

**Required components (for use with single weld plate):**

- 2 ACT Hexagon Head Bolts AS...W55
- 1 ACT Cover Plate DP...W55
- 1 ACT Clamp Body (2 Clamp Halves)
- 1 ACT Single Weld Plate SP...W55

Before welding, always make sure that the designated position of the ACT Weld Plate is suitable for the expected loads.

### Material Code **W55** ACT Mounting Hardware Material Properties and Handling Instructions

ACT Mounting Hardware is made of Stainless Steel V4A (Material Code: W55) with enhanced corrosion resistance by practically excluding metallic and non-metallic impurities during production, processing and handling.

ACT Mounting Hardware is always delivered in hermetically-sealed quality storage bags with 25 pieces each to avoid contamination during transport.

**Always make sure that ACT Mounting Hardware is stored separately from carbon steel and any other metals, and that appropriate tools are used to assemble the clamps.**

### ACT Hexagon Head Bolt Type AS ... W55 (according to DIN 931 / 933)

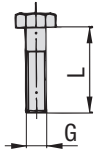

Dimensions applicable only when used with Cover Plate DP and Weld Plate SP



Group STAUFF	DIN	Dimensions (mm/in) Thread G x L	Ordering Code	Packaging Unit (in pieces / bag)
1A	1	M6 x 30	AS-M6x30-W55	25
		M6 x 1.18		
2	2	M6 x 35	AS-M6x35-W55	25
		M6 x 1.38		
3	3	M6 x 40	AS-M6x40-W55	25
		M6 x 1.57		
4	4	M6 x 45	AS-M6x45-W55	25
		M6 x 1.77		
5	5	M6 x 60	AS-M6x60-W55	25
		M6 x 2.36		

### ACT Cover Plate Type DP ... W55

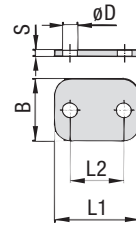

Group STAUFF	DIN	Dimensions (mm/in)						Ordering Code	Packaging Unit (in pieces / bag)
		L1	L2	B	S	ØD			
1A	1	34	20	30	3	7	DP-1A-W55	25	
		1.34	.79	1.18	.12	.28			
2	2	40,5	26	30	3	7	DP-2-W55	25	
		1.59	1.02	1.18	.12	.28			
3	3	48	33	30	3	7	DP-3-W55	25	
		1.89	1.30	1.18	.12	.28			
4	4	57	40	30	3	7	DP-4-W55	25	
		2.24	1.57	1.18	.12	.28			
5	5	70	52	30	3	7	DP-5-W55	25	
		2.76	2.05	1.18	.12	.28			

### ACT Single Weld Plate Type SP ... W55

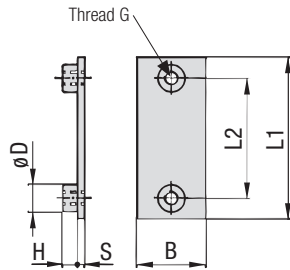

Group STAUFF	DIN	Dimensions (mm/in)							Ordering Code	Packaging Unit (in pieces / bag)
		G	L1	L2	B	S	H	ØD		
1A	1	M6	36	20	30	3	6,5	12	SP-1A-M-W55	25
			1.42	0.79	1.18	.12	.26	.47		
2	2	M6	42	26	30	3	6,5	12	SP-2-M-W55	25
			1.65	1.02	1.18	.12	.26	.47		
3	3	M6	50	33	30	3	6,5	12	SP-3-M-W55	25
			1.97	1.30	1.18	.12	.26	.47		
4	4	M6	60	40	30	3	6,5	12	SP-4-M-W55	25
			2.36	1.57	1.18	.12	.26	.47		
5	5	M6	71	52	30	3	6,5	12	SP-5-M-W55	25
			2.80	2.05	1.18	.12	.26	.47		

### ACT Double Weld Plate Type SPD ... W55

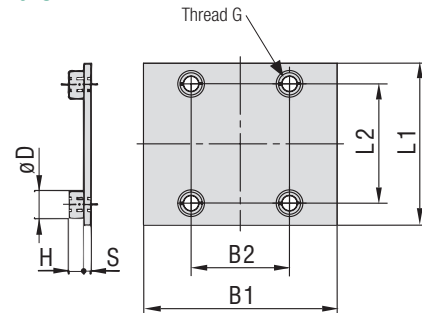

Group STAUFF	DIN	Dimensions (mm/in)								Ordering Code	Packaging Unit (in pieces / bag)
		G	L1	L2	B1	B2	S	H	ØD		
1A	1	M6	36	20	60	30,5	3	6,5	12	SPD-1A-M-W55	25
			1.42	0.79	2.36	1.20	.12	.26	.47		
2	2	M6	42	26	60	30,5	3	6,5	12	SPD-2-M-W55	25
			1.65	1.02	2.36	1.20	.12	.26	.47		
3	3	M6	50	33	60	30,5	3	6,5	12	SPD-3-M-W55	25
			1.97	1.30	2.36	1.20	.12	.26	.47		



Alternative types of weld plates are available upon request. Please contact STAUFF for further information.





### ACT Mounting Hardware Multi-Level Installation (with Weld Plate)

**Required components for each level:**

- 2 ACT Stacking Bolt AF...W55
- 1 ACT Safety Locking Plate SIG...ACT-W55
- 1 ACT Clamp Body (2 Clamp Halves)

The upper layer is secured by a cover plate and hexagon head bolts. The lower layer has to be mounted to a weld plate (with a recommended maximum of two levels in total).

**Material Code** **W55** **ACT Mounting Hardware**  
Material Properties and Handling Instructions

ACT Mounting Hardware is made of Stainless Steel V4A (Material Code: W55) with enhanced corrosion resistance by practically excluding metallic and non-metallic impurities during production, processing and handling.

ACT Mounting Hardware is always delivered in hermetically-sealed quality storage bags with 25 pieces each to avoid contamination during transport.

**Always make sure that ACT Mounting Hardware is stored separately from carbon steel and any other metals, and that appropriate tools are used to assemble the clamps.**

### ACT Stacking Bolt Type AF ... W55

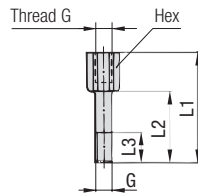

Group	STAUFF	DIN	Dimensions (mm/in)				Ordering Code	Packaging Unit (in pieces / bag)
			G	L1	L2	L3 min. Hex		
1A	1	M6	34	20	12	11	AF-1/1A/1D-M-W55	25
			1.34	.79	.47	.43		
2	2	M6	40	26	12	11	AF-2-M-W55	25
			1.57	1.24	.47	.43		
3	3	M6	44	30	12	11	AF-3-M-W55	25
			1.73	1.18	.47	.43		
4	4	M6	49	35	12	11	AF-4-M-W55	25
			1.93	1.38	.47	.43		
5	5	M6	64	50	12	11	AF-5-M-W55	25
			2.52	1.97	.47	.43		

### ACT Safety Locking Plate Type SIG ... ACT-W55

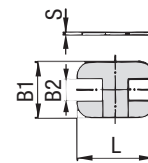

Group	STAUFF	DIN	Dimensions (mm/in)				Ordering Code	Packaging Unit (in pieces / bag)
			L	B1	B2	S		
1A	1		33	28	11,2	2	SIG-1A-ACT-W55	25
			1.30	1.10	.44	.08		
2	2		39	28	11,2	2	SIG-2-ACT-W55	25
			1.54	1.10	.44	.08		
3	3		47	28	11,2	2	SIG-3-ACT-W55	25
			1.85	1.10	.44	.08		
4	4		56	28	11,2	2	SIG-4-ACT-W55	25
			2.20	1.10	.44	.08		
5	5		69	28	11,2	2	SIG-5-ACT-W55	25
			2.72	1.10	.44	.08		





### ACT Mounting Hardware Installation with Channel Rail Adaptors

**Required components:**

- 2 ACT Hexagon Head Bolts AS...W55
- 1 ACT Cover Plate DP...W55
- 1 ACT Clamp Body (2 Clamp Halves)
- 2 ACT Channel Rail Adaptors CRA...W55

Suitable for various brands and types of channel rails (including Halfen, Hilti, Unistrut® etc.).

### Material Code **W55** ACT Mounting Hardware Material Properties and Handling Instructions

ACT Mounting Hardware is made of Stainless Steel V4A (Material Code: W55) with enhanced corrosion resistance by practically excluding metallic and non-metallic impurities during production, processing and handling.

ACT Mounting Hardware is always delivered in hermetically-sealed quality storage bags with 25 pieces each to avoid contamination during transport.

**Always make sure that ACT Mounting Hardware is stored separately from carbon steel and any other metals, and that appropriate tools are used to assemble the clamps.**

### ACT Hexagon Head Bolt Type AS ... W55 (according to DIN 931 / 933)

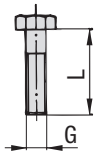

Dimensions applicable only when used with Cover Plate DP and Weld Plate SP



Group STAUFF	DIN	Dimensions (mm/in) Thread G x L	Ordering Code	Packaging Unit (in pieces / bag)
1A	1	M6 x 30	AS-M6x30-W55	25
		M6 x 1.18		
2	2	M6 x 35	AS-M6x35-W55	25
		M6 x 1.38		
3	3	M6 x 40	AS-M6x40-W55	25
		M6 x 1.57		
4	4	M6 x 45	AS-M6x45-W55	25
		M6 x 1.77		
5	5	M6 x 60	AS-M6x60-W55	25
		M6 x 2.36		

### ACT Cover Plate Type DP ... W55

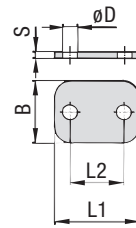

Group STAUFF	DIN	Dimensions (mm/in)					Ordering Code	Packaging Unit (in pieces / bag)
		L1	L2	B	S	ØD		
1A	1	34	20	30	3	7	DP-1A-W55	25
		1.34	.79	1.18	.12	.28		
2	2	40,5	26	30	3	7	DP-2-W55	25
		1.59	1.02	1.18	.12	.28		
3	3	48	33	30	3	7	DP-3-W55	25
		1.89	1.30	1.18	.12	.28		
4	4	57	40	30	3	7	DP-4-W55	25
		2.24	1.57	1.18	.12	.28		
5	5	70	52	30	3	7	DP-5-W55	25
		2.76	2.05	1.18	.12	.28		

### ACT Channel Rail Adaptor Type CRA ... W55

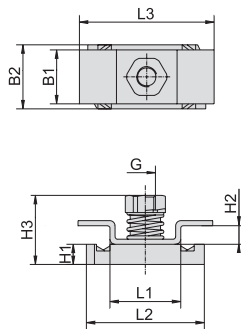

Group STAUFF	DIN	Dimensions (mm/in)									Ordering Code	Packaging Unit (in pieces / bag)
		G	L1	L2	L3	B1	B2	H1	H2	H3		
1A	1	M6	21 .83	35 1.38	40 1.57	16 .63	19 .75	6 .24	5,5 .22	20,5 .81	CRA-1-8/1D-M-W55	25
2	2											
3	3											
4	4											
5	5											

### Suitability Chart for ACT Channel Rail Adaptors in the Standard Series

The STAUFF Channel Rail Adaptor, type CRA, is suitable for various brands and types of channel rails (including Halfen, Hilti, Unistrut® etc.). The drawing describes the basic dimensional requirements for channel rails to be used with STAUFF Channel Rail Adaptors, type CRA.

In case of doubt, please do not hesitate to contact STAUFF prior to field application.

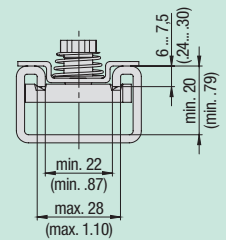

### ACT Mounting Hardware Installation in Field Trays / Cable Ladders



**Required components:**

- 2 ACT Self-Locking Nuts MUS-HKS ... W55
- 1 ACT Cover Plate DP ... W55
- 1 ACT Clamp Body (2 Clamp Halves)
- 2 ACT Hammerhead Bolts HKS ... W55

Suitable for commonly used field trays and cable ladders with diagonal, lengthwise and/or crosswise slots and perforations.

### Material Code **W55** ACT Mounting Hardware Material Properties and Handling Instructions

ACT Mounting Hardware is made of Stainless Steel V4A (Material Code: W55) with enhanced corrosion resistance by practically excluding metallic and non-metallic impurities during production, processing and handling.

ACT Mounting Hardware is always delivered in hermetically-sealed quality storage bags with 25 pieces each to avoid contamination during transport.

**Always make sure that ACT Mounting Hardware is stored separately from carbon steel and any other metals, and that appropriate tools are used to assemble the clamps.**

### All-Metal Self-Locking ACT Nut Type MUS-HKS ... W55 (similar to DIN 980 / Biloc)

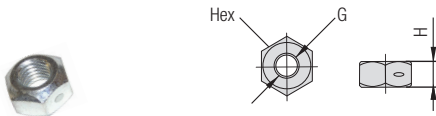

For use with ACT Hammerhead Bolts HKS ... W55

Group	STAUFF	DIN	Dimensions (mm/in)			Ordering Code	Packaging Unit
			Thread G	H	Hex		(in pieces / bag)
1A	1		M6	5	10	MUS-HKS-M6-W55	25
2	2						
3	3						
4	4						
5	5						

### ACT Cover Plate Type DP ... W55

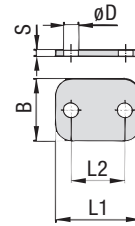

Group	STAUFF	DIN	Dimensions (mm/in)					Ordering Code	Packaging Unit
			L1	L2	B	S	ØD		(in pieces / bag)
1A	1		34	20	30	3	7	DP-1A-W55	25
			1.34	.79	1.18	.12	.28		
2	2		40,5	26	30	3	7	DP-2-W55	25
			1.59	1.02	1.18	.12	.28		
3	3		48	33	30	3	7	DP-3-W55	25
			1.89	1.30	1.18	.12	.28		
4	4		57	40	30	3	7	DP-4-W55	25
			2.24	1.57	1.18	.12	.28		
5	5		70	52	30	3	7	DP-5-W55	25
			2.76	2.05	1.18	.12	.28		

### ACT Hammerhead Bolt Type HKS ... W55

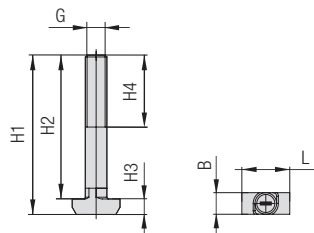

For use with Self-Locking ACT Nuts MUS-HKS ... W55

Group	STAUFF	DIN	Dimensions (mm/in)							Ordering Code	Packaging Unit
			G	H1	H2	H3	H4 min	B	L		(in pcs. / bag)
1A	1	M6	44,3	40	4,3	20	6,1	13,3	HKS-M6x40-W55	25	
			1.74	1.57	.17	.79	.24	.52			
2	2	M6	49,3	45	4,3	20	6,1	13,3	HKS-M6x45-W55	25	
			1.94	1.77	.17	.79	.24	.52			
3	3	M6	54,3	50	4,3	20	6,1	13,3	HKS-M6x50-W55	25	
			2.14	1.97	.17	.79	.24	.52			
4	4	M6	59,3	55	4,3	20	6,1	13,3	HKS-M6x55-W55	25	
			2.33	2.17	.17	.79	.24	.52			
5	5	M6	74,3	70	4,3	20	6,1	13,3	HKS-M6x70-W55	25	
			2.93	2.76	.17	.79	.24	.52			

### Suitability Chart for ACT Hammerhead Bolts in the Standard Series

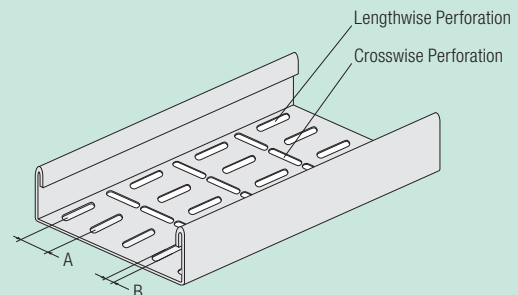

ACT Hammerhead Bolts are suitable for field trays and cable ladders with diagonal, lengthwise and/or crosswise slots and perforations that meet the following requirements:

- **Dimension A:** Equal to the bolt center spacing of the clamp assembly
- **Dimension B:** 6,2 mm ... 7,0 mm / .24 in ... .28 in (Min ... Max)

In case of doubt, please do not hesitate to contact STAUFF prior to field application.





### ACT Mounting Hardware Multi-Level Installation (with Stacking & Hammerhead Bolts)

**Required components (for a recommended maximum of two levels in total):**

- 2 ACT Self-Locking Nuts MUS-HKS ... W55
- 1 ACT Cover Plate DP ... W55
- 1 ACT Clamp Body (2 Clamp Halves)
- 1 ACT Safety Locking Plate SIG...ACT-W55
- 2 ACT Stacking Bolts AF-HKSK...W55
- 1 ACT Clamp Body (2 Clamp Halves)
- 2 ACT Hammerhead Bolts HKSK ... W55

Material Code  
**W55**

### ACT Mounting Hardware Material Properties and Handling Instructions

ACT Mounting Hardware is made of Stainless Steel V4A (Material Code: W55) with enhanced corrosion resistance by practically excluding metallic and non-metallic impurities during production, processing and handling.

ACT Mounting Hardware is always delivered in hermetically-sealed quality storage bags with 25 pieces each to avoid contamination during transport.

**Always make sure that ACT Mounting Hardware is stored separately from carbon steel and any other metals, and that appropriate tools are used to assemble the clamps.**

### All-Metal Self-Locking ACT Nut Type MUS-HKS ... W55 (similar to DIN 980 / Biloc)

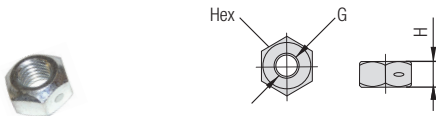

For use with ACT Stacking Bolts AF-HKS ... W55

Group	STAUFF	DIN	Dimensions (mm/in)			Ordering Code	Packaging Unit
			Thread G	H	Hex		(in pieces / bag)
1A	1		M6	5 .20	10 .39	MUS-HKS-M6-W55	25
2	2						
3	3						

### ACT Cover Plate Type DP ... W55

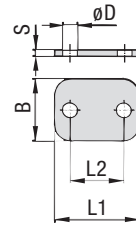

Group	STAUFF	DIN	Dimensions (mm/in)					Ordering Code	Packaging Unit
			L1	L2	B	S	ØD		(in pieces / bag)
1A	1		34	20	30	3	7	DP-1A-W55	25
			1.34	.79	1.18	.12	.28		
2	2		40,5	26	30	3	7	DP-2-W55	25
			1.59	1.02	1.18	.12	.28		
3	3		48	33	30	3	7	DP-3-W55	25
			1.89	1.30	1.18	.12	.28		

### ACT Stacking Bolt Type AF-HKSK ... W55

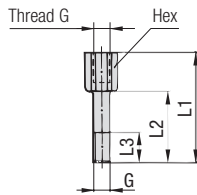

For use with Self-Locking ACT Nuts MUS-HKS ... W55

Group	STAUFF	DIN	Dimensions (mm/in)				Ordering Code	Packaging Unit
			G	L1	L2	L3 min. Hex		(in pieces / bag)
1A	1	M6	44	30	12	11	AF-HKSK-1A-M-W55	25
			1.73	1.18	.47	.43		
2	2	M6	54	40	12	11	AF-HKSK-2-M-W55	25
			2.13	1.57	.47	.43		
3	3	M6	54	40	12	11	AF-HKSK-3-M-W55	25
			2.13	1.57	.47	.43		

### ACT Safety Locking Plate Type SIG ... ACT-W55

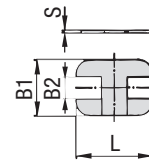

Group	STAUFF	DIN	Dimensions (mm/in)				Ordering Code	Packaging Unit
			L	B1	B2	S		(in pieces / bag)
1A	1		33	28	11,2	2	SIG-1A-ACT-W55	25
			1.30	1.10	.44	.08		
2	2		39	28	11,2	2	SIG-2-ACT-W55	25
			1.54	1.10	.44	.08		
3	3		47	28	11,2	2	SIG-3-ACT-W55	25
			1.85	1.10	.44	.08		

### ACT Hammerhead Bolt Type HKSK ... W55

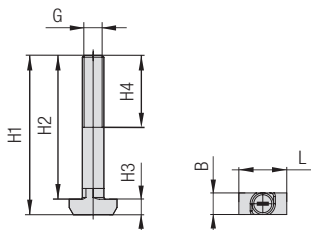

Group	STAUFF	DIN	Dimensions (mm/in)					Ordering Code	Packaging Unit		
			G	H1	H2	H3	H4 min	B	L		(in pcs. / bag)
1A	1	M6	29,3	25	4,3	20	6,1	13,3	HKSK-M6x25-W55	25	
			1.15	.98	.17	.79	.24	.52			
2	2	M6	36,3	32	4,3	20	6,1	13,3	HKSK-M6x32-W55	25	
			1.43	1.26	.17	.79	.24	.52			
3	3	M6	39,3	35	4,3	20	6,1	13,3	HKSK-M6x35-W55	25	
			1.55	1.38	.17	.79	.24	.52			





### ACT Mounting Hardware Multi-Level Installation in Field Trays / Cable Ladders (with Hammerhead Bolts)

**Required components (for a recommended maximum of two levels in total):**

- 2 ACT Self-Locking Nuts MUS-HKS ... W55
- 1 ACT Cover Plate DP ... W55
- 1 ACT Clamp Body (2 Clamp Halves)
- 1 ACT Clamp Body (2 Clamp Halves)
- 2 ACT Hammerhead Bolts HKSV ... W55

### Material Code **W55** ACT Mounting Hardware Material Properties and Handling Instructions

ACT Mounting Hardware is made of Stainless Steel V4A (Material Code: W55) with enhanced corrosion resistance by practically excluding metallic and non-metallic impurities during production, processing and handling.

ACT Mounting Hardware is always delivered in hermetically-sealed quality storage bags with 25 pieces each to avoid contamination during transport.

**Always make sure that ACT Mounting Hardware is stored separately from carbon steel and any other metals, and that appropriate tools are used to assemble the clamps.**

### All-Metal Self-Locking ACT Nut Type MUS-HKS ... W55 (similar to DIN 980 / Biloc)

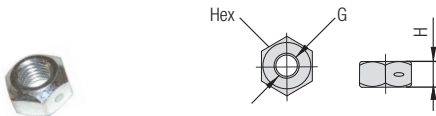

For use with ACT Hammerhead Bolts HKS ... W55

Group	STAUFF	DIN	Dimensions (mm/in)			Ordering Code	Packaging Unit
			Thread G	H	Hex		(in pieces / bag)
1A	1					MUS-HKS-M6-W55	25
2	2	M6	5	10			
3	3		.20	.39			

### ACT Cover Plate Type DP ... W55



Group	STAUFF	DIN	Dimensions (mm/in)					Ordering Code	Packaging Unit
			L1	L2	B	S	ØD		(in pieces / bag)
1A	1		34	20	30	3	7	DP-1A-W55	25
			1.34	.79	1.18	.12	.28		
2	2		40,5	26	30	3	7	DP-2-W55	25
			1.59	1.02	1.18	.12	.28		
3	3		48	33	30	3	7	DP-3-W55	25
			1.89	1.30	1.18	.12	.28		

### ACT Hammerhead Bolt Type HKSV ... W55

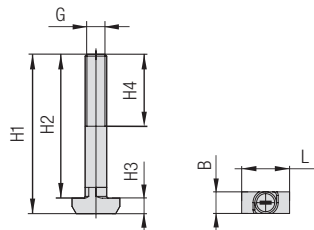

For use with Self-Locking ACT Nuts MUS-HKS ... W55

Group	STAUFF	DIN	Dimensions (mm/in)							Ordering Code	Packaging Unit
			G	H1	H2	H3	H4 min	B	L		(in pcs. / bag)
1A	1	M6	68,3	64	4,3	20	6,1	13,3		HKSV-M6x64-W55	25
			2.69	2.52	.17	.79	.24	.52			
2	2	M6	80,3	76	4,3	20	6,1	13,3		HKSV-M6x76-W55	25
			3.16	2.99	.17	.79	.24	.52			
3	3	M6	87,3	83	4,3	20	6,1	13,3		HKSV-M6x83-W55	25
			3.44	3.27	.17	.79	.24	.52			

### Suitability Chart for ACT Hammerhead Bolts in the Standard Series

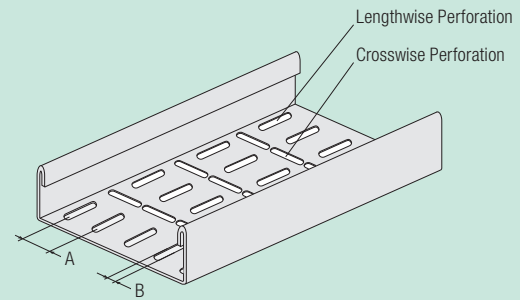

ACT Hammerhead Bolts are suitable for field trays and cable ladders with diagonal, lengthwise and/or crosswise slots and perforations that meet the following requirements:

- **Dimension A:** Equal to the bolt center spacing of the clamp assembly
- **Dimension B:** 6,2 mm ... 7,0 mm / .24 in ... .28 in (Min ... Max)

In case of doubt, please do not hesitate to contact STAUFF prior to field application.

E



**Installation on Weld Plate**

Required components:

- 2 Hexagon Head Bolts AS...W55
- 1 Cover Plate DP...W55
- 1 ACT Clamp Body (2 Clamp Halves)
- 1 Single Weld Plate SP...W55

Before welding, always make sure that the designated position of the weld plate is suitable for the expected loads.

**Order Code**
**SP-110a-ACT-DP-AS-M-W55**

W55 is the recommended option for metal hardware to be used with STAUFF ACT Clamps.

**Multi-Level Installation (with Weld Plate)**

Required components (for each level)  
for a maximum of two levels in total:

- 2 Stacking Bolt AF...W55
- 1 Safety Locking Plate SIG...ACT-W55
- 1 ACT Clamp Body (2 Clamp Halves)

The upper layer has to be secured by a cover plate and hexagon head bolts. The lower level has to be mounted to a weld plate.

**Order Code**
**110a-ACT-SIG-AF-M-W55**

W55 is the recommended option for metal hardware to be used with STAUFF ACT Clamps.

**Installation with Channel Rail Adaptors**

Required components:

- 2 Hexagon Head Bolts AS...W55
- 1 Cover Plate DP...W55
- 1 Clamp Body (2 Clamp Halves)
- 2 Channel Rail Adaptors CRA...W55

Suitable for various brands and types of channel rails (including Halfen, Hiiti, Unistrut® etc.).

**Order Code**
**CRA-110a-ACT-DP-AS-M-W55**

W55 is the recommended option for metal hardware to be used with STAUFF ACT Clamps.

**Installation in Field Trays / Cable Ladders**

Required components:

- 2 Self-Locking Nuts MUS-HKS ... W55
- 1 Cover Plate DP ... W55
- 1 Clamp Body (2 Clamp Halves)
- 2 Hammerhead Bolts HKS ... W55

Suitable for commonly used field trays and cable ladders with diagonal, lengthwise and/or crosswise slots and perforations.

**Order Code**
**HKS-110a-ACT-DP-MUS-M-W55**

W55 is the recommended option for metal hardware to be used with STAUFF ACT Clamps.

**Multi-Level Installation  
in Field Trays / Cable Ladders**

Required components  
(for a maximum of two levels in total):

- 2 Self-Locking Nuts MUS-HKS ... W55
- 1 Cover Plate DP ... W55
- 1 ACT Clamp Body (2 Clamp Halves)
- 1 Safety Locking Plate SIG...ACT-W55
- 2 Stacking Bolts AF-HKSK...W55
- 1 ACT Clamp Body (2 Clamp Halves)
- 2 Hammerhead Bolts HKSK ... W55

Suitable for commonly used field trays and cable ladders with diagonal, lengthwise and/or crosswise slots and perforations.

**Order Codes**

Upper Level: **HKSK-212.7-ACT-DP-MUS-M-W55**  
Lower Level: **212.7-ACT-SIG-AF-HKSK-M-W55**

W55 is the recommended option for metal hardware to be used with STAUFF ACT Clamps.

**Multi-Level Installation  
in Field Trays / Cable Ladders**

Required components  
(for a maximum of two levels in total):

- 2 Self-Locking Nuts MUS-HKS ... W55
- 1 Cover Plate DP ... W55
- 1 ACT Clamp Body (2 Clamp Halves)
- 1 ACT Clamp Body (2 Clamp Halves)
- 2 Hammerhead Bolts HKSV ... W55

Suitable for commonly used field trays and cable ladders with diagonal, lengthwise and/or crosswise slots and perforations.

**Order Codes**

Upper Level: **212.7-ACT** (Clamp Body only)  
Lower Level: **HKSV-212.7-ACT-DP-MUS-M-W55**

W55 is the recommended option for metal hardware to be used with STAUFF ACT Clamps.

**E**

Twin Series according to DIN 3015, Part 3  
ACT Clamp Body

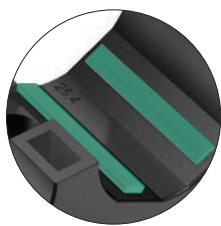

Integrated Rubber Strips  
made of Anti-Corrosion Elastomer (ACE)

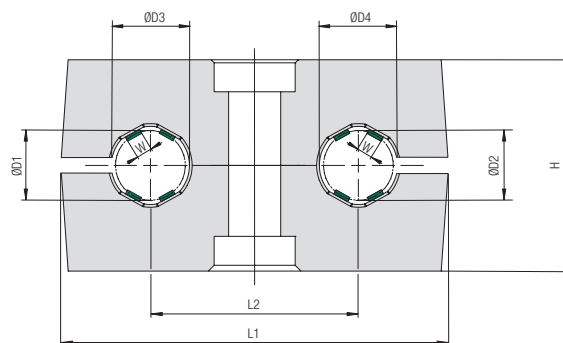

Ordering Codes

Clamp Body **\*2\*12.7/12.7-\*ACT**

One clamp body consists of two identical clamp halves, each with four integrated rubber strips.

- \* 1<sup>st</sup> Part of STAUFF Group **2**
- \* Exact outside diameters Ø D1 / Ø D2 (mm) **12.7/12.7**
- \* Material code **ACT**

Group Size		Outside Diameters Ø D1 / Ø D2		Ordering Code	Packaging Unit	Dimensions (mm/in)					
STAUFF	DIN	(mm)	(in)	(2 Clamp Halves)	(in pieces / bag)	ØD3/ ØD4	W	L1	L2	H	Width
1D	1	6		106/06-ACT	25	9 .35	1,4 .06	36 1.42	20 .79	26,6 1.05	30 1.18
		6,4	1/4	106.4/06.4-ACT	25	9,4 .37	1,5 .06				
		9,5	3/8	109.5/09.5-ACT	25	12,5 .49	2,2 .09				
		10		110/10-ACT	25	13 .51	2,3 .09				
		12		112/12-ACT	25	15 .59	2,8 .11				
2D	2	12,7	1/2	212.7/12.7-ACT	25	15,7 .62	3,5 .14	53 2.09	29 1.14	26,6 1.05	30 1.18
		14		214/14-ACT	25	17 .67	3,5 .14				
3D	3	18		318/18-ACT	25	21 .83	3,5 .14	67 2.64	36 1.42	36,6 1.44	30 1.18
		19	3/4	319/19-ACT	25	22 .87	3,5 .14				
		20		320/20-ACT	25	23 .91	3,5 .14				
		21,3		321.3/21.3-ACT	25	24,3 .96	3,5 .14				
		25,4	1	325.4/25.4-ACT	25	28,4 1.12	3,5 .14				

Additional outside diameters and combinations of different outside diameters are available upon request.  
Please contact STAUFF for further information.



## ACT Mounting Hardware Installation on Single Weld Plates



### Required components:

- 1 ACT Hexagon Head Bolt AS...W55
- 1 ACT Cover Plate GD...W55
- 1 ACT Clamp Body (2 Clamp Halves)
- 1 ACT Single Weld Plate SP...W55

Before welding, always make sure that the designated position of the ACT Weld Plate is suitable for the expected loads.

## Material Code **W55** ACT Mounting Hardware Material Properties and Handling Instructions

ACT Mounting Hardware is made of Stainless Steel V4A (Material Code: W55) with enhanced corrosion resistance by practically excluding metallic and non-metallic impurities during production, processing and handling.

ACT Mounting Hardware is always delivered in hermetically-sealed quality storage bags with 25 pieces each to avoid contamination during transport.

**Always make sure that ACT Mounting Hardware is stored separately from carbon steel and any other metals, and that appropriate tools are used to assemble the clamps.**

## ACT Hexagon Head Bolt Type AS ... W55 (according to DIN 931 / 933)

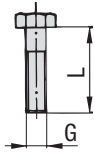

Dimensions applicable only when used with Cover Plate GD and Weld Plate SP



Group	Dimensions (mm/in)	Ordering Code	Packaging Unit
STAUFF	DIN	Thread G x L	(in pieces / bag)
1D	1	M6 x 35	25
		M6 x 1.38	
2D	2	M8 x 35	25
		M8 x 1.38	
3D	3	M8 x 45	25
		M8 x 1.77	

## ACT Cover Plate Type GD ... W55

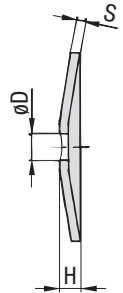
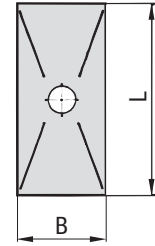

Group	Dimensions (mm/in)	Ordering Code	Packaging Unit
STAUFF	DIN	L B H S ØD	(in pieces / bag)
1D	1	34 30 7 3 7	25
		1.34 1.18 .28 .12 .28	
2D	2	52 30 7 3 9	25
		2.05 1.18 .28 .12 .35	
3D	3	65 30 7 3 9	25
		2.56 1.18 .28 .12 .35	

## ACT Single Weld Plate Type SP ... W55

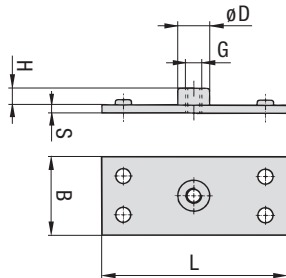

Group	Dimensions (mm/in)	Ordering Code	Packaging Unit
STAUFF	DIN	G L B S H ØD	(in pieces / bag)
1D	1	M6	25
		37 30 3 6.5 12	
		1.46 1.18 .12 .26 .47	
2D	2	M8	25
		55 30 5 6 14	
		2.17 1.18 .20 .24 .55	
3D	3	M8	25
		70 30 5 6 14	
		2.76 1.18 .20 .24 .55	



### ACT Mounting Hardware Multi-Level Installation (with Weld Plate)



**Required components for each level:**

- 1 ACT Stacking Bolt AF...W55
- 1 ACT Safety Locking Plate SIV...ACT
- 1 ACT Clamp Body (2 Clamp Halves)

The upper layer is secured by a cover plate and hexagon head bolts. The lower layer has to be mounted to a weld plate (with a recommended maximum of two levels in total).

### Material Code **W55** ACT Mounting Hardware Material Properties and Handling Instructions

ACT Mounting Hardware is made of Stainless Steel V4A (Material Code: W55) with enhanced corrosion resistance by practically excluding metallic and non-metallic impurities during production, processing and handling.

ACT Mounting Hardware is always delivered in hermetically-sealed quality storage bags with 25 pieces each to avoid contamination during transport.

**Always make sure that ACT Mounting Hardware is stored separately from carbon steel and any other metals, and that appropriate tools are used to assemble the clamps.**

### ACT Stacking Bolt Type AF ... W55

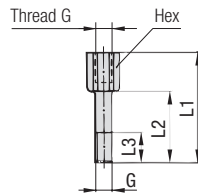

Group	STAUFF	DIN	Dimensions (mm/in)					Order Code	Packaging Unit (in pieces / bag)
			G	L1	L2	L3 min.	Hex		
1D	1	M6	34	20	12	11	AF-1/1A/1D-M-W55	25	
			1.33	.78	.47	.43			
2D	2	M8	33	20	11	12	AF-2D-M-W55	25	
			1.30	.78	.43	.47			
			44	29	15	12			
3D	3	M8	44	29	15	12	AF-3D-M-W55	25	
			1.73	1.14	.59	.47			

### ACT Safety Locking Plate Type SIV ... ACT

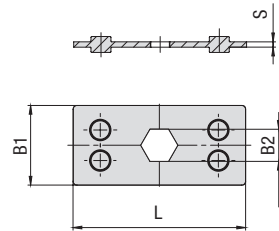

Made of flame-retardant PP-V0 plastic material; tested and V0 classified according to UL 94

Group	STAUFF	DIN	Dimensions (mm/in)				Order Code	Packaging Unit (in pieces / bag)
			L	B1	B2	S		
1D	1		34	30	11,2	2	SIV-1D-PP-V0-ACT	25
			1.39	1.18	.44	.08		
2D	2		52	30	12,1	2	SIV-2D-PP-V0-ACT	25
			2.05	1.18	.48	.08		
			65	30	12,1	2		
3D	3		65	30	12,1	2	SIV-3D-PP-V0-ACT	25
			2.56	1.18	.48	.08		



## ACT Mounting Hardware Installation with Channel Rail Adaptors



### Required components:

- 1 ACT Hexagon Head Bolt AS...W55
- 1 ACT Cover Plate GD...W55
- 1 ACT Clamp Body (2 Clamp Halves)
- 1 ACT Channel Rail Adaptor CRA...W55

Suitable for various brands and types of channel rails (including Halfen, Hilti, Unistrut® etc.).

## Material Code **W55** ACT Mounting Hardware Material Properties and Handling Instructions

ACT Mounting Hardware is made of Stainless Steel V4A (Material Code: W55) with enhanced corrosion resistance by practically excluding metallic and non-metallic impurities during production, processing and handling.

ACT Mounting Hardware is always delivered in hermetically-sealed quality storage bags with 25 pieces each to avoid contamination during transport.

**Always make sure that ACT Mounting Hardware is stored separately from carbon steel and any other metals, and that appropriate tools are used to assemble the clamps.**

## ACT Hexagon Head Bolt Type AS ... W55 (according to DIN 931 / 933)

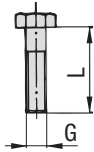

Dimensions applicable only when used with Cover Plate GD and Weld Plate SP



Group	STAUFF	DIN	Dimensions (mm/in) Thread G x L	Ordering Code	Packaging Unit (in pieces / bag)
1D	1		M6 x 35	AS-M6x35-W55	25
			M6 x 1.38		
2D	2		M8 x 35	AS-M8x35-W55	25
			M8 x 1.38		
3D	3		M8 x 45	AS-M8x45-W55	25
			M8 x 1.77		

## ACT Cover Plate Type GD ... W55

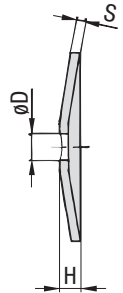
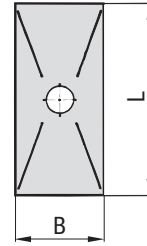

Group	STAUFF	DIN	Dimensions (mm/in)					Ordering Code	Packaging Unit (in pieces / bag)
			L	B	H	S	ØD		
1D	1		34	30	7	3	7	GD-1D-W55	25
			1.34	1.18	.28	.12	.28		
2D	2		52	30	7	3	9	GD-2D-W55	25
			2.05	1.18	.28	.12	.35		
3D	3		65	30	7	3	9	GD-3D-W55	25
			2.56	1.18	.28	.12	.35		

## Channel Rail Adaptor Type CRA ... W55

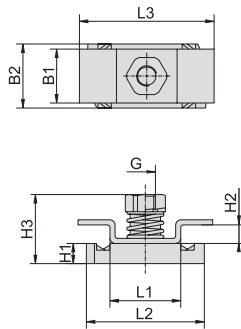

Group	STAUFF	DIN	Dimensions (mm/in)							Order Code	Packaging Unit (in pieces / bag)		
			G	L1	L2	L3	B1	B2	H1	H2	H3		
1D	1		M6	21	35	40	16	19	6	5,5	20,5	CRA-1-8/1D-M-W55	25
				.83	1.38	1.57	.63	.75	.24	.22	.81		
2D	2		M8	21	35	38	53	19	9	5,5	23,5	CRA-2-3D-M-W55	25
3D	3			.83	1.38	1.50	2.09	.75	.35	.22	.93		

### Suitability Chart for ACT Channel Rail Adaptors in the Twin Series

The STAUFF Channel Rail Adaptor, type CRA, is suitable for various brands and types of channel rails (including Halfen, Hilti, Unistrut® etc.). The drawing describes the basic dimensional requirements for channel rails to be used with STAUFF Channel Rail Adaptors, type CRA.

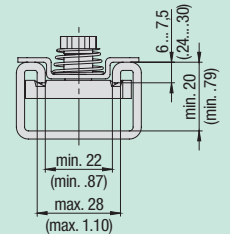

In case of doubt, please do not hesitate to contact STAUFF prior to field application.



### ACT Mounting Hardware Installation in Field Trays / Cable Ladders

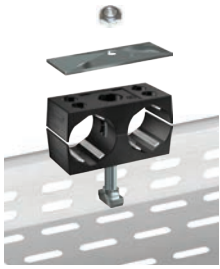

**Required components:**

- 1 ACT Self-Locking Nut MUS-HKS ... W55
- 1 ACT Cover Plate GD ... W55
- 1 ACT Clamp Body (2 Clamp Halves)
- 1 ACT Hammerhead Bolt HKS ... W55

Suitable for commonly used field trays and cable ladders with diagonal, lengthwise and/or crosswise slots and perforations.

### Material Code **W55** ACT Mounting Hardware Material Properties and Handling Instructions

ACT Mounting Hardware is made of Stainless Steel V4A (Material Code: W55) with enhanced corrosion resistance by practically excluding metallic and non-metallic impurities during production, processing and handling.

ACT Mounting Hardware is always delivered in hermetically-sealed quality storage bags with 25 pieces each to avoid contamination during transport.

**Always make sure that ACT Mounting Hardware is stored separately from carbon steel and any other metals, and that appropriate tools are used to assemble the clamps.**

### All-Metal Self-Locking ACT Nut Type MUS-HKS ... W55 (similar to DIN 980 / Biloc)

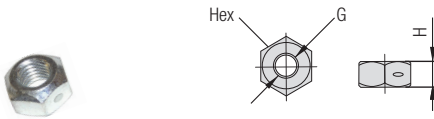

For use with ACT Hammerhead Bolts HKS ... W55

Group	STAUFF	DIN	Dimensions (mm/in)			Ordering Code	Packaging Unit
			Thread G	H	Hex		(in pieces / bag)
1D	1	M6	.20	5	.39	MUS-HKS-M6-W55	25
2D	2	M8	.26	6.5	.51	MUS-HKS-M8-W55	25
3D	3						

### ACT Cover Plate Type GD ... W55

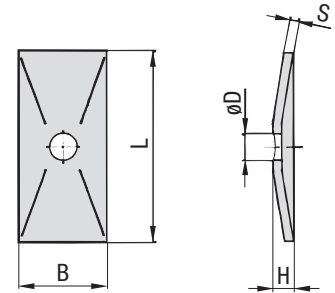

Group	STAUFF	DIN	Dimensions (mm/in)					Ordering Code	Packaging Unit
			L	B	H	S	ØD		(in pieces / bag)
1D	1	1	34	30	7	3	7	GD-1D-W55	25
			1.34	1.18	.28	.12	.28		
2D	2	2	52	30	7	3	9	GD-2D-W55	25
			2.05	1.18	.28	.12	.35		
3D	3	3	65	30	7	3	9	GD-3D-W55	25
			2.56	1.18	.28	.12	.35		

### ACT Hammerhead Bolt Type HKS ... W55

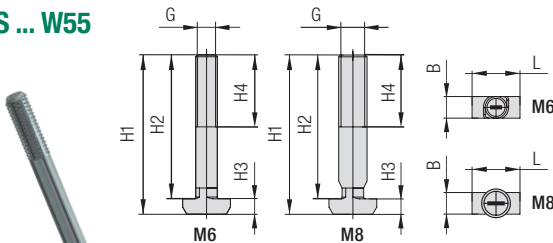

For use with Self-Locking ACT Nuts MUS-HKS ... W55

Group	STAUFF	DIN	Dimensions (mm/in)							Ordering Code	Packaging Unit
			G	H1	H2	H3	H4 min	B	L		(in pcs. / bag)
1D	1	M6	49,3	45	4,3	20	6,1	13,3	HKS-M6x45-W55	25	
			1.94	1.77	.17	.79	.24	.52			
2D	2	M8	49,3	45	4,3	20	6	13,3	HKS-M8x45-W55	25	
			1.94	1.77	.17	.79	.24	.52			
3D	3	M8	59,3	55	4,3	20	6	13,3	HKS-M8x55-W55	25	
			2.33	2.17	.17	.79	.24	.52			

### Suitability Chart for ACT Hammerhead Bolts in the Twin Series

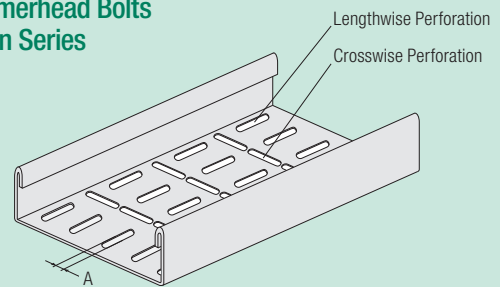

ACT Hammerhead Bolts are suitable for field trays and cable ladders with diagonal, lengthwise and/or crosswise slots and perforations that meet the following requirements:

- **Dimension A:** 6,2 mm ... 7,0 mm / .24 in ... .28 in (Min ... Max)

In case of doubt, please do not hesitate to contact STAUFF prior to field application.



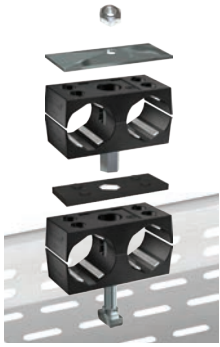

### ACT Mounting Hardware Multi-Level Installation (with Stacking & Hammerhead Bolts)

**Required components (for a recommended maximum of two levels in total):**

- 1 ACT Self-Locking Nut MUS-HKS ... W55
- 1 ACT Cover Plate GD ... W55
- 1 ACT Clamp Body (2 Clamp Halves)
- 1 ACT Stacking Bolt AF-HSK...W55
- 1 ACT Safety Locking Plate SIV...ACT
- 1 ACT Clamp Body (2 Clamp Halves)
- 1 ACT Hammerhead Bolt HSKS ... W55

Material Code  
**W55**

### ACT Mounting Hardware Material Properties and Handling Instructions

ACT Mounting Hardware is made of Stainless Steel V4A (Material Code: W55) with enhanced corrosion resistance by practically excluding metallic and non-metallic impurities during production, processing and handling.

ACT Mounting Hardware is always delivered in hermetically-sealed quality storage bags with 25 pieces each to avoid contamination during transport.

**Always make sure that ACT Mounting Hardware is stored separately from carbon steel and any other metals, and that appropriate tools are used to assemble the clamps.**

### All-Metal Self-Locking ACT Nut Type MUS-HKS ... W55 (similar to DIN 980 / Biloc)

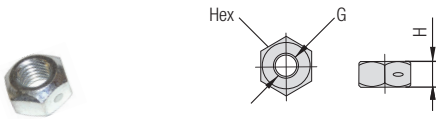

For use with ACT Stacking Bolts AF-HKS ... W55

Group	STAUFF	DIN	Dimensions (mm/in)			Ordering Code	Packaging Unit
			Thread G	H	Hex		(in pieces / bag)
1D	1	M6	5 .20	10	.39	MUS-HKS-M6-W55	25
2D	2	M8	6.5 .26	13	.51	MUS-HKS-M8-W55	25
3D	3						

### ACT Cover Plate Type GD ... W55



Group	STAUFF	DIN	Dimensions (mm/in)					Ordering Code	Packaging Unit
			L	B	H	S	ØD	(in pieces / bag)	
1D	1	1	34 1.34	30 1.18	7 .28	3 .12	7 .28	GD-1D-W55	25
2D	2		52 2.05	30 1.18	7 .28	3 .12	9 .35		
3D	3	3	65 2.56	30 1.18	7 .28	3 .12	9 .35	GD-3D-W55	25

### ACT Stacking Bolt Type AF-HSKS ... W55



For use with Self-Locking ACT Nuts MUS-HKS ... W55

Group	STAUFF	DIN	Dimensions (mm/in)	Order Code	Packaging Unit			
			G L1 L2 L3 min. Hex		(in pieces / bag)			
1D	1	M6	49 1.93	35 1.38	12 .47	11 .43	AF-HSKS-1D-M-W55	25
2D	2	M8	50 1.97	37 1.47	11 .43	12 .47	AF-HSKS-2D-M-W55	25
3D	3		61 2.40	46 1.81	15 .59	12 .47		

### ACT Safety Locking Plate Type SIV ... ACT

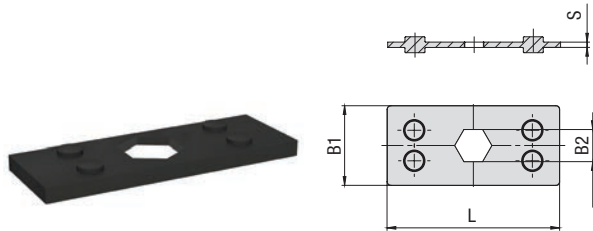

Made of flame-retardant PP-V0 plastic material; tested and V0 classified according to UL 94

Group	STAUFF	DIN	Dimensions (mm/in)				Order Code	Packaging Unit
			L	B1	B2	S	(in pieces / bag)	
1D	1	1	34 1.39	30 1.18	11,2 .44	2 .08	SIV-1D-PP-V0-ACT	25
2D	2		52 2.05	30 1.18	12,1 .48	2 .08		
3D	3	3	65 2.56	30 1.18	12,1 .48	2 .08	SIV-3D-PP-V0-ACT	25

### ACT Hammerhead Bolt Type HSKS ... W55

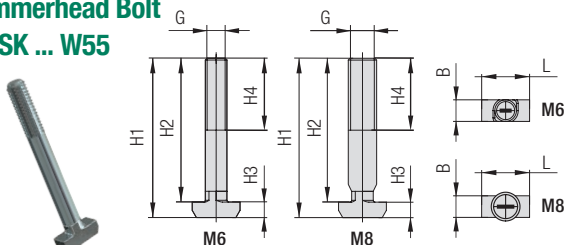

Group	STAUFF	DIN	Dimensions (mm/in)					Ordering Code	Packaging Unit	
			G	H1	H2	H3	H4 min	B	L	(in pcs. / bag)
1D	1	M6	29,3 1.15	25 .98	4,3 .17	20 .79	6,1 .24	13,3 .52	HSKS-M6x25-W55	25
2D	2		32,3 1.27	28 1.10	4,3 .17	20 .79	6 .24	13,3 .52		
3D	3	M8	42,3 1.67	38 1.50	4,3 .17	20 .79	6 .24	13,3 .52	HSKS-M8x38-W55	25



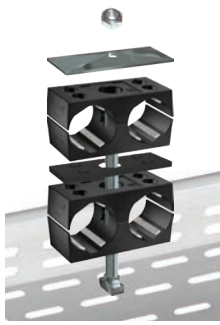

### ACT Mounting Hardware Multi-Level Installation in Field Trays / Cable Ladders (with Hammerhead Bolts)

**Required components (for a recommended maximum of two levels in total):**

- 1 ACT Self-Locking Nut MUS-HKS ... W55
- 1 ACT Cover Plate GD ... W55
- 1 ACT Clamp Body (2 Clamp Halves)
- 1 ACT Safety Locking Plate SIV-ACT
- 1 ACT Clamp Body (2 Clamp Halves)
- 1 ACT Hammerhead Bolt HKS ... W55

### Material Code **W55** ACT Mounting Hardware Material Properties and Handling Instructions

ACT Mounting Hardware is made of Stainless Steel V4A (Material Code: W55) with enhanced corrosion resistance by practically excluding metallic and non-metallic impurities during production, processing and handling.

ACT Mounting Hardware is always delivered in hermetically-sealed quality storage bags with 25 pieces each to avoid contamination during transport.

**Always make sure that ACT Mounting Hardware is stored separately from carbon steel and any other metals, and that appropriate tools are used to assemble the clamps.**

### All-Metal Self-Locking ACT Nut Type MUS-HKS ... W55 (similar to DIN 980 / Biloc)

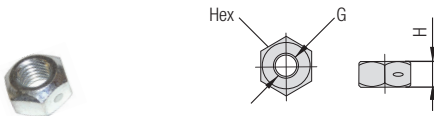

For use with ACT Hammerhead Bolts HKS ... W55

Group	STAUFF	DIN	Dimensions (mm/in)			Ordering Code	Packaging Unit
			Thread G	H	Hex		(in pieces / bag)
1D	1	M6		5 .20	10 .39	MUS-HKS-M6-W55	25
2D	2	M8		6.5 .26	13 .51	MUS-HKS-M8-W55	25
3D	3						

### ACT Cover Plate Type GD ... W55

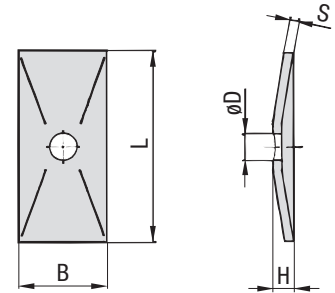

Group	STAUFF	DIN	Dimensions (mm/in)					Ordering Code	Packaging Unit
			L	B	H	S	ØD	(in pieces / bag)	
1D	1		34	30	7	3	7	GD-1D-W55	25
2D	2		52	30	7	3	9	GD-2D-W55	25
3D	3		65	30	7	3	9	GD-3D-W55	25
			2.56	1.18	.28	.12	.35		

### ACT Hammerhead Bolt Type HKS ... W55

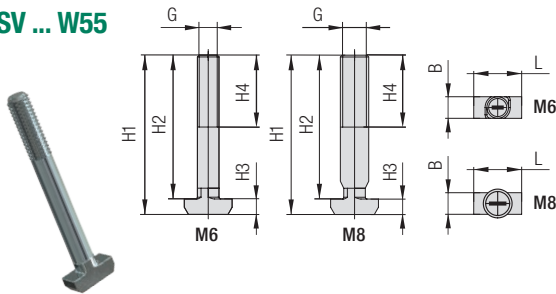

For use with Self-Locking ACT Nuts MUS-HKS ... W55

Group	STAUFF	DIN	Dimensions (mm/in)							Ordering Code	Packaging Unit
			G	H1	H2	H3	H4 min	B	L		(in pcs. / bag)
1D	1	M6	76,3	72	4,3	20	6,1	13,3		HKS-M6x72-W55	25
2D	2	M8	77,3	73	4,3	20	6	13,3		HKS-M8x73-W55	25
			3,04	2,87	.17	.79	.24	.52			
3D	3	M8	97,3	93	4,3	20	6	13,3		HKS-M8x93-W55	25
			3,83	3,66	.17	.79	.24	.52			

### ACT Safety Locking Plate Type SIV ... ACT

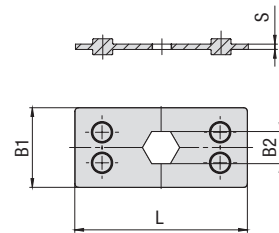

Made of flame-retardant PP-V0 plastic material; tested and V0 classified according to UL 94

Group	STAUFF	DIN	Dimensions (mm/in)				Order Code	Packaging Unit
			L	B1	B2	S	(in pieces / bag)	
1D	1		34	30	11,2	2	SIV-1D-PP-V0-ACT	25
2D	2		52	30	12,1	2	SIV-2D-PP-V0-ACT	25
3D	3		65	30	12,1	2	SIV-3D-PP-V0-ACT	25
			2.56	1.18	.48	.08		



**Installation on Weld Plate**
Required components:

- 1 Hexagon Head Bolt AS...W55
- 1 Cover Plate GD...W55
- 1 ACT Clamp Body (2 Clamp Halves)
- 1 Single Weld Plate SP...W55

Before welding, always make sure that the designated position of the weld plate is suitable for the expected loads.

**Order Code**
**SP-110/10-ACT-GD-AS-M-W55**

W55 is the recommended option for metal hardware to be used with STAUFF ACT Clamps.

**Multi-Level Installation (with Weld Plate)**
Required components (for each level)  
for a maximum of two levels in total:

- 1 Stacking Bolt AF...W55
- 1 Safety Locking Plate SIG...W55
- 1 ACT Clamp Body (2 Clamp Halves)

The upper layer has to be secured by a cover plate and hexagon head bolts. The lower level has to be mounted to a weld plate.

**Order Code**
**110/10-ACT-SIV-ACT-AF-M-W55**

W55 is the recommended option for metal hardware to be used with STAUFF ACT Clamps.

**Installation with Channel Rail Adaptors**
Required components:

- 1 Hexagon Head Bolt AS...W55
- 1 Cover Plate GD...W55
- 1 ACT Clamp Body (2 Clamp Halves)
- 1 Channel Rail Adaptor CRA...W55

Suitable for various brands and types of channel rails (including Halfen, Hiiti, Unistrut® etc.).

**Order Code**
**CRA-110/10-ACT-GD-AS-M-W55**

W55 is the recommended option for metal hardware to be used with STAUFF ACT Clamps.

**Installation in Field Trays / Cable Ladders**
Required components:

- 1 Self-Locking Nut MUS-HKS ... W55
- 1 Cover Plate GD ... W55
- 1 ACT Clamp Body (2 Clamp Halves)
- 1 Hammerhead Bolt HKS ... W55

Suitable for commonly used field trays and cable ladders with diagonal, lengthwise and/or crosswise slots and perforations.



**Order Code**
**HKS-110/10-ACT-GD-MUS-M-W55**

W55 is the recommended option for metal hardware to be used with STAUFF ACT Clamps.

**Multi-Level Installation  
in Field Trays / Cable Ladders**
Required components  
(for a maximum of two levels in total):

- 1 Self-Locking Nut MUS-HKS ... W55
- 1 Cover Plate GD ... W55
- 1 ACT Clamp Body (2 Clamp Halves)
- 1 Stacking Bolt AF-HKSK...W55
- 1 Safety Locking Plate SIV...ACT
- 1 ACT Clamp Body (2 Clamp Halves)
- 1 Hammerhead Bolt HKSK ... W55

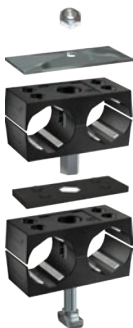
Suitable for commonly used field trays and cable ladders with diagonal, lengthwise and/or crosswise slots and perforations.

**Order Codes**

Upper Level: **HKSK-212.7/12.7-ACT-GD-MUS-M-W55**  
Lower Level: **212.7/12.7-ACT-SIV-ACT-AF-HKSK-M-W55**

W55 is the recommended option for metal hardware to be used with STAUFF ACT Clamps.

**Multi-Level Installation  
in Field Trays / Cable Ladders**
Required components  
(for a maximum of two levels in total):

- 1 Self-Locking Nut MUS-HKS ... W55
- 1 Cover Plate GD ... W55
- 1 ACT Clamp Body (2 Clamp Halves)
- 1 Safety Locking Plate SIV-ACT
- 1 ACT Clamp Body (2 Clamp Halves)
- 1 Hammerhead Bolt HKSV ... W55

Suitable for commonly used field trays and cable ladders with diagonal, lengthwise and/or crosswise slots and perforations.













**Order Codes**

Upper Level: **212.7/12.7-ACT-SIV-ACT**  
Lower Level: **HKSV-212.7/12.7-ACT-GD-MUS-M-W55**

W55 is the recommended option for metal hardware to be used with STAUFF ACT Clamps.





	<b>Introduction</b>	92
	<b>Weld Stud with Female Thread</b> SWG-SF	92
	<b>Distance Plate for DIN 3015 Clamps</b> SWG-DIP	93
	<b>Cable Tie Holder</b> SWG-CTH-11-M6	93
	<b>Cable Tie / Tension Belt Holder</b> SWG-CTH-30-M6-1	93
	<b>Cable Tie / Tension Belt Holder</b> SWG-CTH-30-M6-2	93
	<b>Starterkit</b> SWG-WI06-Starterkit	94
	<b>Weld Inverter</b> SWG-WI06	94
	<b>Weld Gun - Arc Ignition</b> SWG-WG	94
	<b>Distance Adaptor</b> SWG-AGS	95
	<b>Distance Tube</b> DIT-SR6-SWG	95
	<b>Stud Retainer</b> SWG-SR6	95
	<b>Ground Cable</b> SWG-GC	95



## STAUFF SWG Stud Welding System

In many areas, stud welding is considered to be the most economic fastening method for components and is sometimes even the only technically feasible solution. Because the stud is joined with the substructure over the entire surface of the stud, a high strength of the joint can be achieved.

STAUFF is now using this proven principle for the installation of pipe, tube, hose and cable clamps in the Standard Series (according to DIN 3015, part 1) as well as in the Twin Series (according to DIN 3015, part 3) with M6 mounting thread, where female threaded weld studs replace the regular weld plates; distance plates made from plastic provide the necessary spacing between the clamp bodies and the substructure.

If required, the system can also be adopted for alternative fastening methods, e.g. for clamping belts, cable ties or conduit hoses.

In addition to the individual components – weld studs, distance plates, clamp bodies and metal hardware required – STAUFF also provides the correspondingly designed assembly tools such as the weld inverter and the weld gun with distance tube, stud retainer and distance adaptor for DIN 3015 clamps. The lightweight and compact weld inverter works without high-voltage current.

Thanks to increased productivity and flexibility for the installation of clamps, the system offers considerable savings potentials for users with significant processing volumes, especially when working in horizontal or overhead position. The amount of rework on welding locations can be significantly decreased, and material distortion is reduced to a minimum through low thermal stress.

The joint of the weld stud with the substructure impresses in particular with a high degree of strength and safety, which is at least at the same level as for regular weld plates.

- Developed and optimised to the functions of original STAUFF Clamps in the Standard Series (DIN 3015, Part 1)
- Versatile combination and adaptation options available (e.g. fastening elements for conduit hoses, clamping belts and cable ties)
- All installation options are fully covered by only one weld stud
- Significant time and cost savings by a quicker welding process and reduced rework on welding locations
- Material distortion reduced to a minimum through low thermal stress (particularly significant when handling thin metal sheets)
- High degree of safety and protection against corrosion due to a welded joint over the whole surface
- Lightweight and compact designed welding inverter
- By default no shielding gas or ceramic ferrule required
- Works without high-voltage current

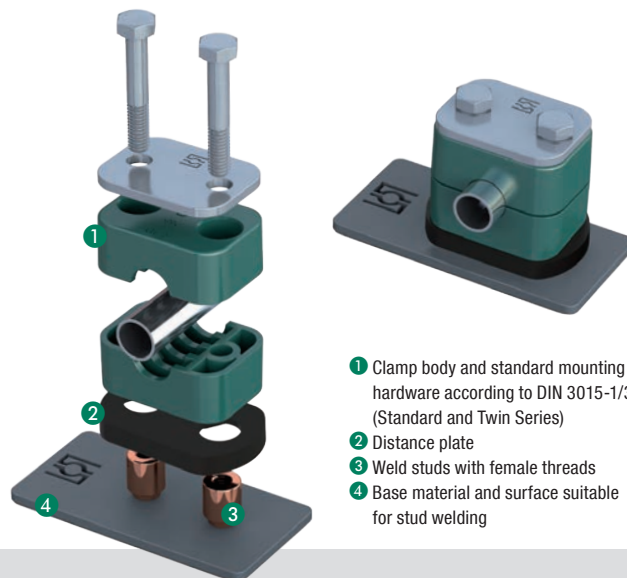

- 1 Clamp body and standard mounting hardware according to DIN 3015-1/3 (Standard and Twin Series)
- 2 Distance plate
- 3 Weld studs with female threads
- 4 Base material and surface suitable for stud welding

Assembly using weld plates  
100%

Reduction of the assembly time per clamp\*

Assembly using the stud welding system  
23%

\*For a typical assembly procedure in production environments.

## Weld Stud with Female Thread Type SWG-SF

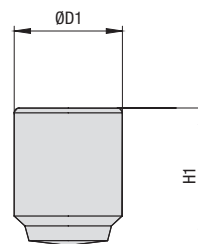

Ordering Codes			
<b>Weld Stud</b>	<b>*SWG-SF-*M6x11x14-*W124</b>		
<b>* Weld Stud with Female Thread</b>	<b>SWG-SF</b>		
<b>* Thread code</b>	Metric ISO thread	<b>M6x11x14</b>	
	Unified coarse (UNC) thread	<b>UNC1/4-20x11x14</b>	
<b>* Material code</b>	Steel 4.8 with galvanised copper coating C1E (DIN EN ISO 4042)	<b>W124</b>	

Group	STAUFF	DIN	Dimensions (mm/in)			Order Codes (Standard Options)	Packaging Units (in pcs. / per bag)
			Thread G	ØD1	H1		
1 ... 8	0 ... 8		M6	11	14	SWG-SF-M6x11x14-W124	100
				.43	.55		
			1/4-20 UNC	11	14	SWG-SF-UNC1/4-20x11x14-W124	
				.43	.55		

Alternative materials are available upon request. Please contact STAUFF for further information.

Maximum torque rating: 6 N·m / 4.43 ft·lb. Specific series can further limit the torque rating. In case of doubt, please contact STAUFF in advance.

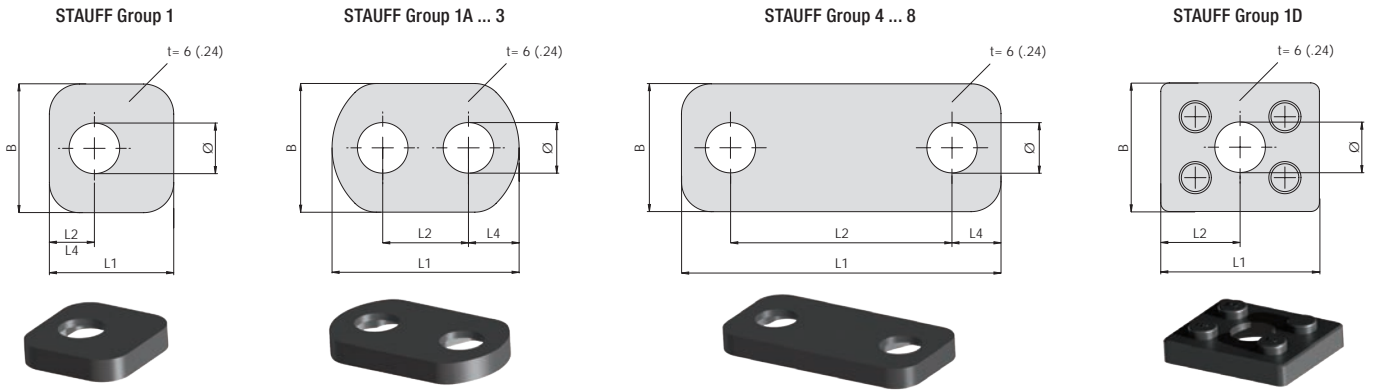

**Distance Plate for DIN 3015 Clamps  
Type SWG-DIP**

Group STAUFF	DIN	Pipe/Tube-Ø (mm/in) Clamp Body	Dimensions (mm/in)					Order Codes (Standard Options)	Packaging Units (in pcs. / per bag)
			L1	L2*	L4	B	Ø		
1	0	6 ... 12	29	10,5	10,5	30	11,8	SWG-DIP-1-PP-BK	25
		.24 ... .48	1.14	.41	.41	1.18	.46		
1A	1	6 ... 12	43,5	20	11,8	30	11,8	SWG-DIP-1A-PP-BK	25
		.24 ... .48	1.71	.79	.46	1.18	.46		
2	2	12,7 ... 18	48,5	26	11,3	30	11,8	SWG-DIP-2-PP-BK	25
		.50 ... .71	1.90	1.02	.44	1.18	.46		
3	3	19 ... 25,4	56,5	33	11,8	30	11,8	SWG-DIP-3-PP-BK	25
		.75 ... 1.00	2.22	1.30	.46	1.18	.46		
4	4	26,9 ... 32	62	40	11	30	11,8	SWG-DIP-4-PP-BK	25
		1.06 ... 1.26	2.44	1.57	.43	1.18	.46		
5	5	32 ... 42	75	52	11,5	30	11,8	SWG-DIP-5-PP-BK	25
		1.26 ... 1.65	2.95	2.05	.45	1.18	.46		
6	6	44,5 ... 54	88	66	11	30	11,8	SWG-DIP-6-PP-BK	25
		1.75 ... 2.12	3.46	2.60	.43	1.18	.46		
7	7	57,2 ... 76,1	121	94	13,5	30	11,8	SWG-DIP-7-PP-BK	10
		2.25 ... 3.00	4.76	3.70	.53	1.18	.46		
8	8	88,9 ... 102	147	120	13,5	30	11,8	SWG-DIP-8-PP-BK	10
		3.50 ... 4.00	5.78	4.72	.53	1.18	.46		
1D	1	6 ... 12	37	18,5	-	30	11,8	SWG-DIP-1D-PP-BK	25
		.24 ... .48	1.45	.73	-	1.18	.46		

**Ordering Codes**
**Distance Plate** \*SWG-DIP\*2\*PP-BK

\* Distance Plate SWG-DIP

\* STAUFF Group 2

\* Material code Polypropylene (Colour: Black) PP-BK

Alternative materials are available upon request. Please contact STAUFF for further information.

\* ±0,1(.003)

Material: Polyamide (reinforced)

Suitable for hexagon socket button cap screws M6x12 (ISO 7380-1)

Standard packaging unit: 25 pcs.

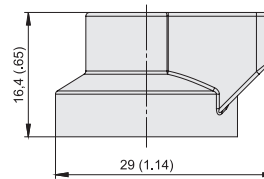
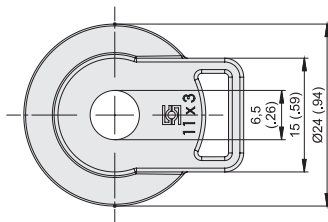
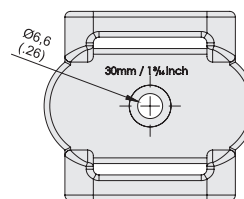
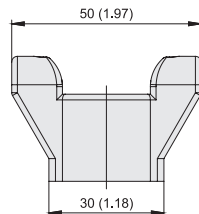
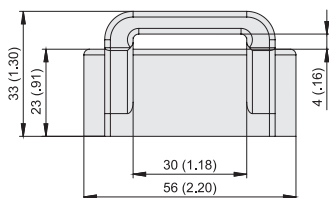

**Cable Tie Holder  
Type SWG-CTH-11-M6**

Material: Polyamide (reinforced)

Suitable for socket cap screws M6x12 (ISO 4762) or hexagon socket button cap screws M6x12 (ISO 7380-1)

Standard packaging unit: 25 pcs.

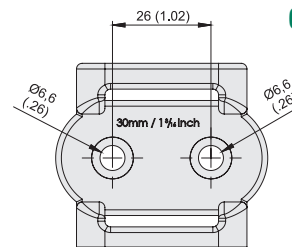
Dimensional drawings: All dimensions in mm (in).

**Cable Tie / Tension Belt Holder  
Type SWG-CTH-30-M6-1**

**Cable Tie / Tension Belt Holder  
Type SWG-CTH-30-M6-2**

## Starterkit Type SWG-WI06-Starterkit



### Starterkit including:

- 1 Weld Inverter **SWG-WI06**
- 1 Weld Gun **SWG-WG**
- 1 Ground Cable **SWG-GC**
- 1 Distance Tube **DIT-SR6-SWG-WG30**  
(for STAUFF Groups 2 to 8)
- 5 Stud Retainer **SWG-SR6**
- 1 Toolkit (Box Spanner/Hex Wrench)
- Operating Manual (English / German)

### Required Accessories:

- Distance Adaptor **SWG-AGS-...** for DIN 3015 Clamps
- Weld Stud **SWG-SF**
- Distance Tube **DIT-SR6-SWG-WG25**  
(for STAUFF Group 1A, if required)

## Weld Inverter Type SWG-WI06

F



### Characteristics

- Works without high-voltage current
- No heavy extension cords required
- Extremely powerful and robust
- Compact in design
- Lightweight with only 18 kg / 40 lbs
- Welding current: 100 ... 650 A (stepless control)
- Welding time: 5 ... 200 ms (stepless control)
- Connection Cable: 3 m / 9.84 ft

### Required Accessories

- Weld Gun **SWG-WG** and Accessories
- Ground Cable **SWG-GC**

### Technical Data

#### Primary Power

- 100 V to 240 V, 1 phase, 50/60 Hz, 16 AT

#### Primary Plug

- 16 A 2-pin grounded safety plug (plug type F CEE 7/4)

#### IP Code

- IP 44 (also permits operation outdoors)

#### Ambient Temperature Limits

- ±0 °C ... +40 °C / +32 °F ... +104 °F

#### Dimensions (L x W x H)

- 474 x 337 x 351 mm / 18.66 x 13.27 x 13.82 in

## Weld Gun - Arc Ignition Type SWG-WG

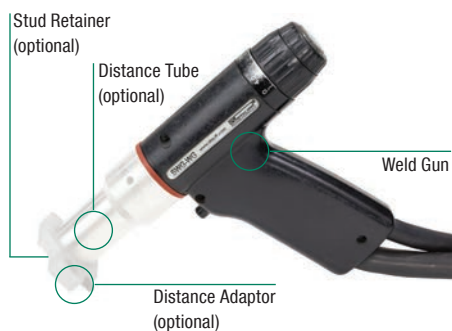

### Characteristics

- Compact in design
- Lightweight with only 0,8 kg / 1.8 lbs (without cable)
- Ergonomic handle
- Comfortable setup
- Connection Cable: 5 m / 16.40 ft

### Required Accessories

- Distance Adaptor **SWG-AGS-...** for DIN 3015 Clamps
- Distance Tube **DIT-SR6-SWG-WG30** (for STAUFF Groups 2 to 8)
- Distance Tube **DIT-SR6-SWG-WG25** (for STAUFF Group 1A)
- Stud Retainer **SWG-SR6**

### Technical Data

#### Lift

- Adjustment range 3 mm / .11 in, lockable

#### Workplace noise level

- Up to 90 dB (A) may occur during welding

#### Dimensions (L x W x H)

- 200 x 65 x 140 mm / 7.87 x 2.56 x 5.51 in  
(without cable, without distance tube)



**Distance Adaptor  
Type SWG-AGS**

Group STAUFF	DIN	for use with	Ordering Codes
1	0	Distance Tube <b>Type A</b>	NO DISTANCE ADAPTOR REQUIRED
1A	1	Distance Tube <b>Type A</b>	SWG-AGS-1A
2	2	Distance Tube <b>Type B</b>	SWG-AGS-2
3	3	Distance Tube <b>Type B</b>	SWG-AGS-3
4	4	Distance Tube <b>Type B</b>	SWG-AGS-4
5	5	Distance Tube <b>Type B</b>	SWG-AGS-5
6	6	Distance Tube <b>Type B</b>	SWG-AGS-6
7	7	Distance Tube <b>Type B</b>	SWG-AGS-7
8	8	Distance Tube <b>Type B</b>	SWG-AGS-8
1D	1D	Distance Tube <b>Type A</b>	NO DISTANCE ADAPTOR REQUIRED

**Distance Tube  
Type DIT-SR6-SWG**

Type	for use with	Ordering Codes
A	Distance Adaptor <b>SWG-AGS-1A</b>	DIT-SR6-SWG-WG25
B	Distance Adaptor <b>SWG-AGS-2...8</b>	DIT-SR6-SWG-WG30

**F**
**Stud Retainer  
Type SWG-SR6**
**Order Code**

**① Type**

 Stud Retainer **SWG-SR6**

Standard packaging unit: 5 pcs.



**Order Code**



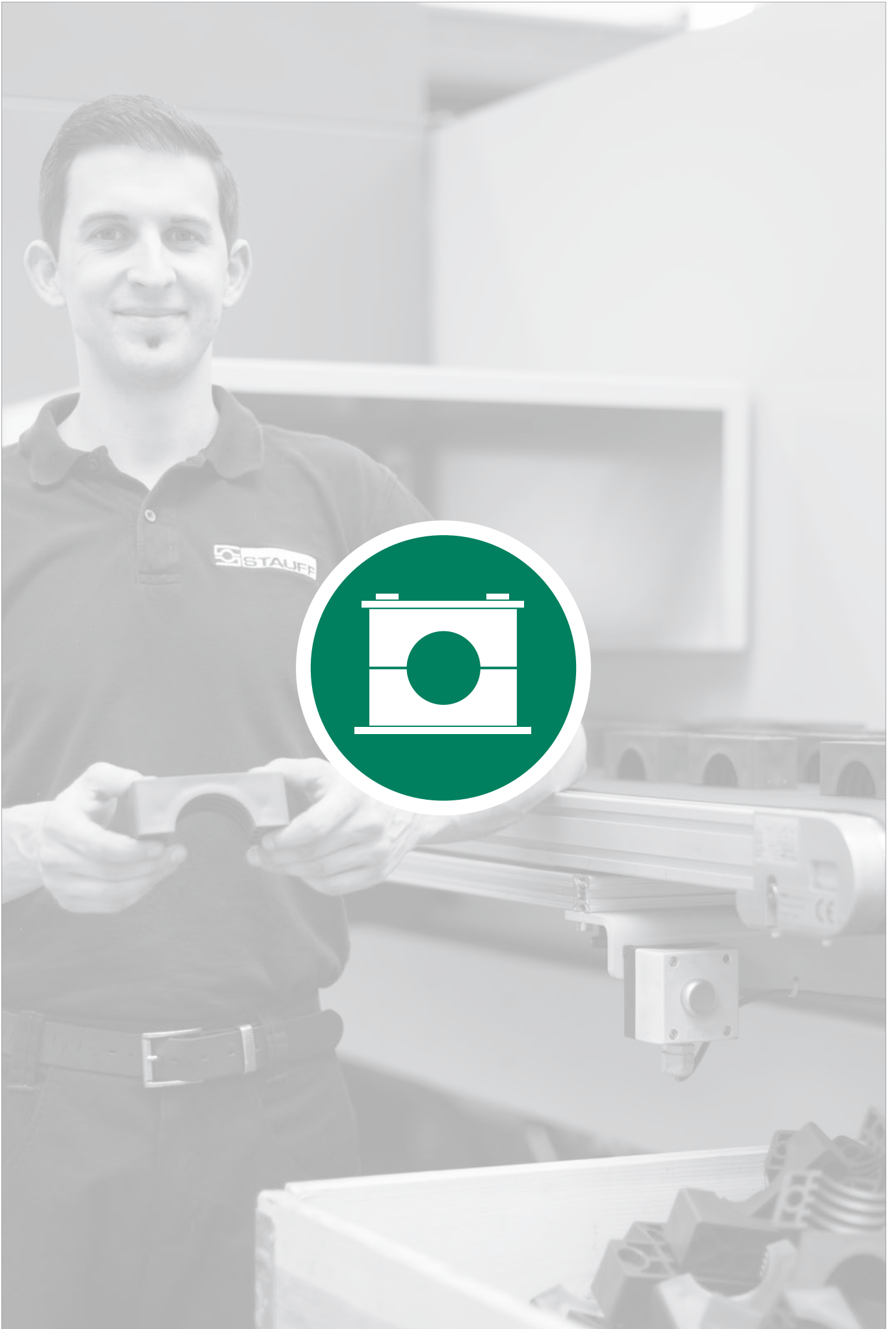

**① Type**

 Ground Cable **SWG-GC**
**Characteristics**

- Cable length: 5 m / 16.40 ft
- Equipped with 2 vice grips 10"

**Ground Cable  
Type SWG-GC**

	<b>Introduction</b>	98
	<b>STAUFF Bond Plate for DIN 3015 Clamps</b> SBP	99
	<b>Adhesive Cartridge</b> CB420-50(E)	100
	<b>Manual Adhesive Dispenser</b> SBD	101
	<b>Dispenser Slide</b> SBDS-81	101
	<b>Mixing Tip</b> SBMT	101



## STAUFF Bond Adhesive Bonded Fastening

The innovative STAUFF Bond system allows for pipes, tubes, hoses, cables and other components with outside diameters up to 102 mm / 4.00 in to be adhesively bonded to almost any surface material, such as prepared or unprepared metals, thermoplastics and composites.

It enables assembly and service technicians such as tube fitters to replace expensive and sometimes complicated mechanical fastening methods for STAUFF Clamps such as welding, brazing, bolting and riveting - a crucial benefit especially in safety-critical situations where welding is usually not considered to be an option.

- Reduce cycle time and labor cost during installation
- Eliminate need for hot work, fire watch and gas freeing
- Expensive tools and welding equipment no longer necessary
- No external power supply or electrical power required for installation
- Can be used with a variety of surfaces, especially in safety-critical situations when welding is not an option
- Enhance structural design, strength and integrity
- Reduce number of holes drilled into the structure
- Prevent galvanic corrosion and potential leak paths
- Maximize design and work sequence flexibility
- Facilitate last minute changes and additions
- Simplify subsequent modification and repair

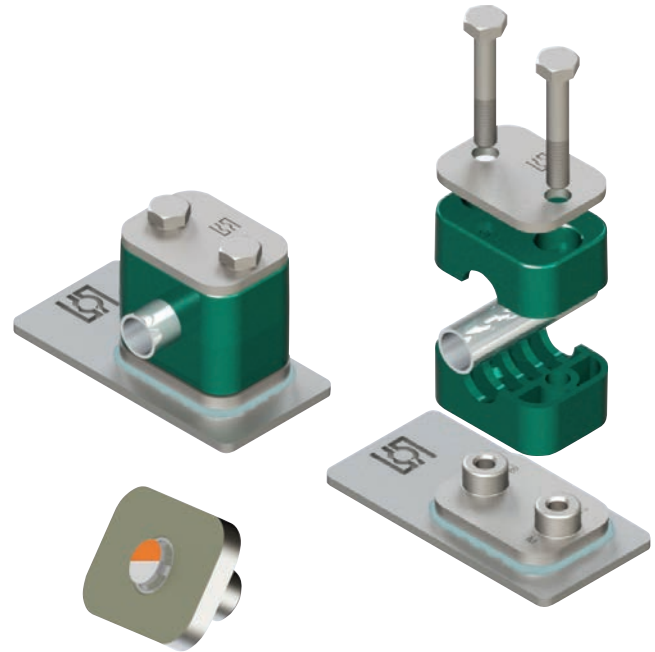

G



Tensile testing of the STAUFF Bond Plate (type SBP) with STAUFF Bond Adhesive (type CB420-50E) in the STAUFF Technology Centre. Please contact STAUFF for detailed test reports.

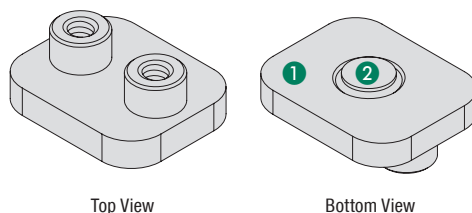
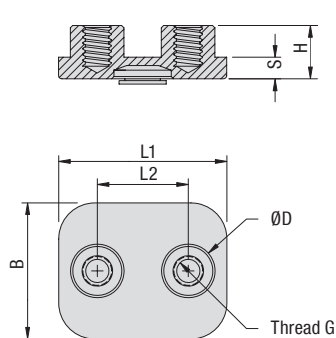

**STAUFF Bond Plate for DIN 3015 Clamps  
Type SBP**

- ① Adhesive to be applied to this primed area of the bond plate
- ② Internal dynamic installation fixture providing constant positive pressure and holding the bond plate in position while the adhesive cures<sup>1</sup>

Group STAUFF	DIN	Diameter (mm/in)		Dimensions (mm/in)							Order Codes (Standard Options)	Packaging Unit (in Pieces)
		Clamp Body	Thread G	L1	L2	B	S	H	ØD			
1A	1	6 ... 12	M6	36	20	30	5	11,3	11,8	SBP-1A-M-W5	25	
		.24 ... .48	1/4-20 UNC	1.42	.79	1.18	.20	.44	.46	SBP-1A-U-W5		
2	2	12,7 ... 18	M6	42	26	30	5	11,3	11,8	SBP-2-M-W5	25	
		.50 ... .71	1/4-20 UNC	1.65	1.02	1.18	.20	.44	.46	SBP-2-U-W5		
3	3	19 ... 25,4	M6	50	33	30	5	11,3	11,8	SBP-3-M-W5	25	
		.75 ... 1.00	1/4-20 UNC	1.97	1.30	1.18	.20	.44	.46	SBP-3-U-W5		
4	4	26,9 ... 32	M6	60	40	30	5	11,3	11,8	SBP-4-M-W5	25	
		1.06 ... 1.26	1/4-20 UNC	2.36	1.57	1.18	.20	.44	.46	SBP-4-U-W5		
5	5	32 ... 42	M6	71	52	30	5	11,3	11,8	SBP-5-M-W5	25	
		1.26 ... 1.65	1/4-20 UNC	2.80	2.05	1.18	.20	.44	.46	SBP-5-U-W5		
6 <sup>1</sup>	6	44,5 ... 54	M6	88	66	30	5	11,3	11,8	SBP-6-M-W5	25	
		1.75 ... 2.12	1/4-20 UNC	3.46	2.60	1.18	.20	.44	.46	SBP-6-U-W5		

**Ordering Codes**
**STAUFF Bond Plate \*SBP-\*2-\*M-\*W5**

* STAUFF Bond Plate		<b>SBP</b>
* STAUFF Group		<b>2</b>
* Thread code	Metric ISO thread	<b>M</b>
	Unified coarse (UNC) thread	<b>U</b>
* Material code	Stainless Steel V4A 1.4408 (AISI 316)	<b>W5</b>

Please note: The bonding surface of the STAUFF Bond Plate is primed with a two-component chemically cured waterborne primer (MIL-PRF-85582) that forms a film that is resistant to chemicals, solvents, moisture and abrasion.

<sup>1</sup>Please note: For STAUFF Group 6, STAUFF Bond Plates are equipped with each two internal installation fixtures.



## Adhesive Cartridge Type CB420-50(E)



### Characteristics

The STAUFF Bond acrylic structural adhesive is a two-component thixotropic paste adhesive (mixing ratio of 10:1) packed in a suitable 50 ml / 1.69 oz dual cartridge.

It is capable of bonding a wide variety of prepared or unprepared metals, engineering thermoplastics and composites, and replacing commonly used mechanical fastening methods such as welding, brazing, bolting and riveting in various industries.

The STAUFF Bond adhesive cures quickly at room temperature and exhibits excellent environmental and chemical resistance.

### Ordering Code

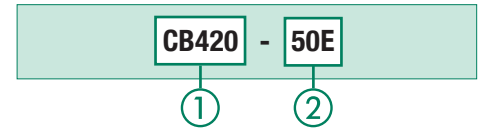

#### ① Type

Adhesive Cartridge **CB420**

#### ② Execution

International **50**  
Europe (Delivery Standard Europe) **50E**

### Required Accessories

- Adhesive Dispenser, Dispenser Slide, Mixing Tip

Recommended number of STAUFF Bond Plates SBP to be installed with a single Adhesive Cartridge Type CB420-50(E)								
STAUFF Group	1A	2	3	4	5	6	7	8
No. of Bond Plates	25	25	20	20	15	15	5	5

### Processing instructions

#### Cure Time

15 to 18 minutes to 75% of ultimate strength and 24 hours to 100% of ultimate strength at room temperature of +24 °C / +75 °F.

#### Shelf Life

Minimum 9 months when stored in a dry place and in the original package at temperatures from +13 °C to +24 °C / +55 °F to +75 °F

Shelf life can be maximized by refrigeration at temperatures from +7 °C to +13 °C / +45 °F to +55 °F.

Do not freeze adhesive!

#### Temperature

Operating temperature range from -55 °C to +121 °C / -67 °F to +240 °F.

Pay attention to the expiry dates printed on the cartridges.

Alternative types of adhesives are available on request. Please contact STAUFF for further information.

Find the safety data sheets at [www.stauff.com/en/bond/sds](http://www.stauff.com/en/bond/sds)

## Installation Guideline

### Surface Preparation

Thorough surface preparation is an essential part of adhesive bonding and at least as important as the actual installation.

Lightly abrade glossy surfaces to improve the adhesive bond strength. Just prior to adhesive application, clean surfaces with solvent using clean and lintless rags or paper towels. Do not use shop towels, rags or paper wipes contaminated with oil, soap or reclaimed solvents.

Clean one small area at a time, then dry with a clean cloth before the solvent evaporates to prevent re-deposition of contaminants. To maintain a clean solvent supply, always pour the solvent onto the washing cloth.

You may also want to clean the bottom of the bond plate prior to adhesive preparation. Use a clean cloth saturated with solvent to wipe the part with a single circular motion. Use caution not to disturb the internal fixture.

Safety note: Always wear gloves and protective glasses!

### Dispensing Directions

- Place the cartridge into the retaining lip on the dispensing gun. Mark the position of the cap of the cartridge, remove it by turning counter-clockwise and keep it for later use. When reclosing the cartridge, the cap must be used in the exact same position as it was before to avoid unwanted mixing and curing.
- Activate the dispensing gun slightly to extrude a small amount of adhesive onto scrap material to ensure adequate flow of both components. Attach the mixing tip to the adhesive cartridge and dispense a small line of adhesive onto scrap material to ensure adequate mixing.
- Remove the protective foil from the internal dynamic installation fixture(s) of the bond plate.
- Apply suitable amount of adhesive to the bonding surface of the bond plate (see drawing on the left), position the part in the desired location on the surface and press lightly on the center of the bond plate to actuate the installation fixture(s), which will provide constant positive pressure and hold the bond plate in position while the adhesive cures.

- A consistent bead of adhesive around the outside edges of the bond plate indicates proper installation and is a good visual quality assurance check.
- When not in use, remove and dispose the mixing tip and replace the cap to preserve remaining adhesive.

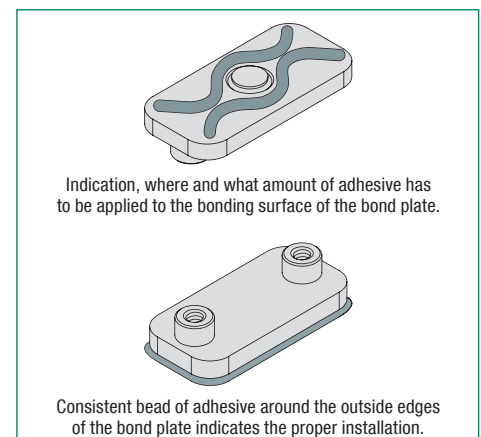

Selection, proper application and correct installation of the products are the user's responsibility!

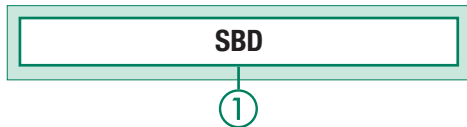

**Manual Adhesive Dispenser  
Type SBD**
**Ordering Code**

**① Type**

Manual Adhesive Dispenser **SBD**

**Characteristics**

The STAUFF Bond Manual Adhesive Dispenser has been designed for use with STAUFF Bond dual adhesive cartridges. It is paired with a specific slide for dispensing adhesives with the correct mixing ratio.

**Required Accessories**

- Dispenser Slide, Mixing Tip

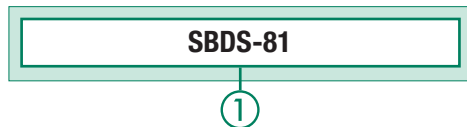
**Dispenser Slide  
Type SBDS-81**
**Ordering Code**

**① Type**

Dispenser Slide **SBDS-81**

**Characteristics**

The STAUFF Dispenser Slide is used in combination with the Manual Adhesive Dispenser and provides the required mixing ratio for the dispensing adhesives.

**Required Accessories**

- Adhesive Dispenser, Mixing Tip

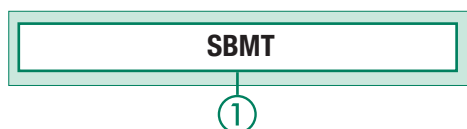
**Mixing Tip  
Type SBMT**
**Ordering Code**

**① Type**

Mixing Tip **SBMT**

**Characteristics**

The STAUFF Mixing Tip is designed to twist and lock onto the end of the adhesive cartridge. It does not only provide proper interleaving of pre-portioned components but additionally pre-phasing to ensure optimum mix uniformity.

To prevent pre-mix of the adhesive, the tip integrates a barrier separating the individual adhesive components until they reach the integral mixer. If open time of adhesive in the mixing tip exceeds the adhesive pot life, the adhesive will become cured in the tip, preventing further dispensing. Removal of the used tip and replacement with a fresh tip is as simple as twisting to remove the cured tip, wiping off the end of the cartridge, and twisting a new tip in place.



Standard packaging unit: 50 pcs.

**Required Accessories**

- Adhesive Dispenser, Dispenser Slide







Machined Versions

104



Injection Moulded Version

106



Metal Versions and Accessories

107

Enquiry Form for Custom-Designed Special Clamps

108



### Machined Versions

Custom-designed clamping systems for pipes, tubes, hoses, cables and other components according to customer's specifications or based on STAUFF developments, made of thermoplastics, metals and non-ferrous metals.

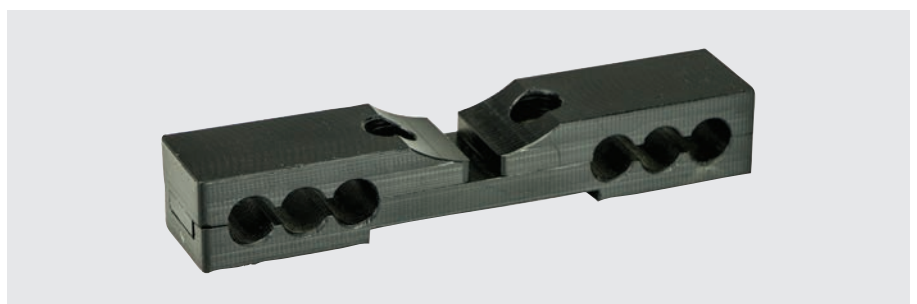
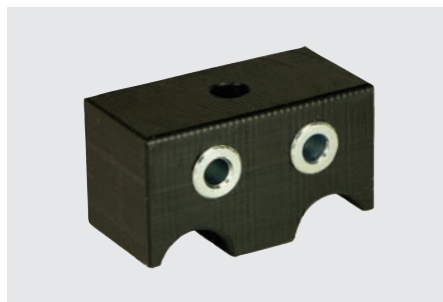
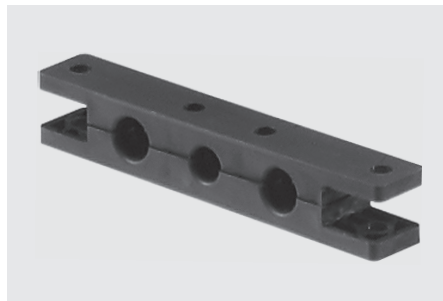

H



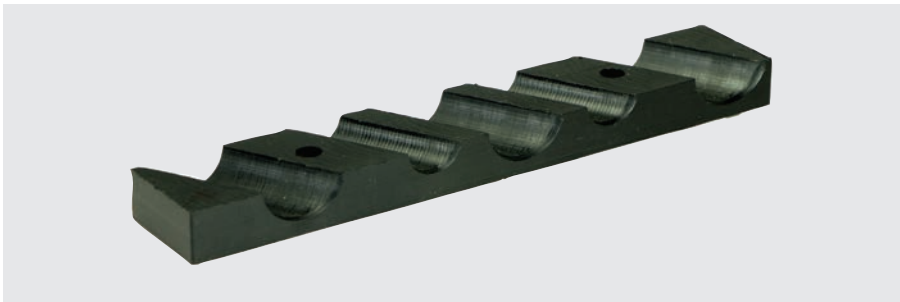

H

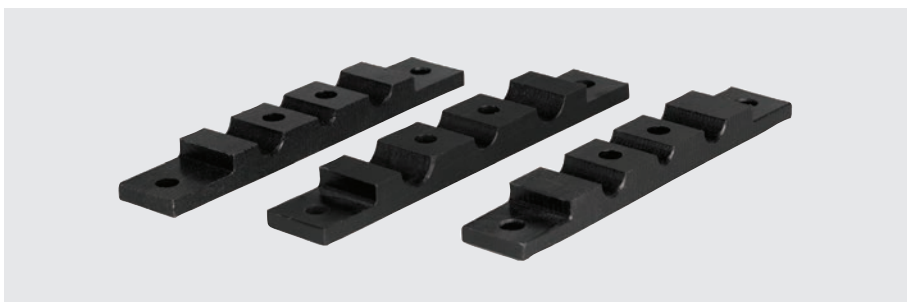

### Injection Moulded Versions (Flexi Clamps)

Custom-designed clamping systems for pipes, tubes, hoses, cables and other components according to customer's specifications or based on STAUFF developments, made of Polypropylene, Polyamide and other thermoplastics.

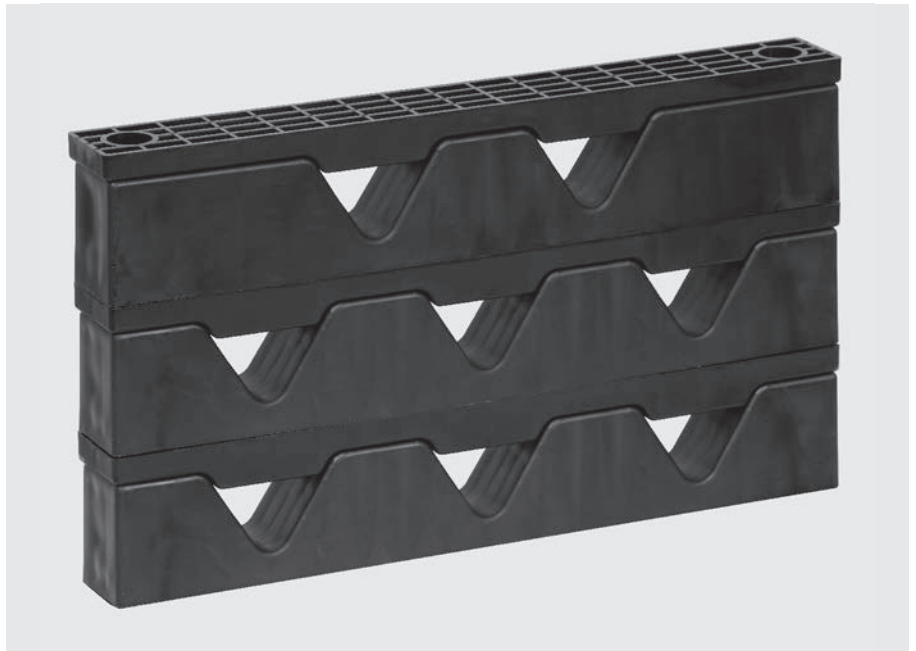

H



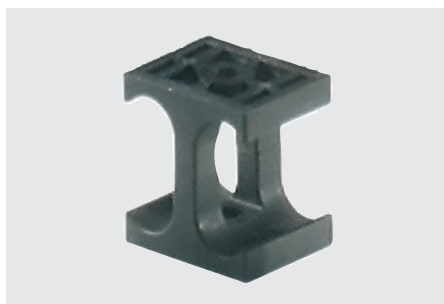
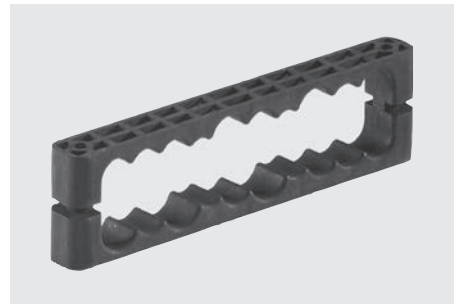
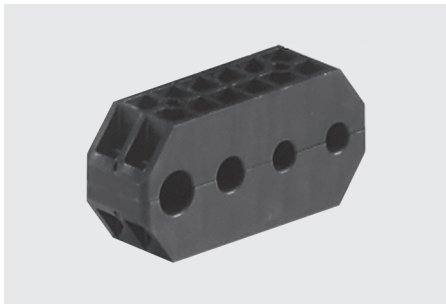

**Metal Versions and Accessories**

Metal versions of custom-designed clamping systems for pipes, tubes, hoses, cables and other components as well as accessories such as weld plates, cover plates, bolts as well as elastomer inserts.

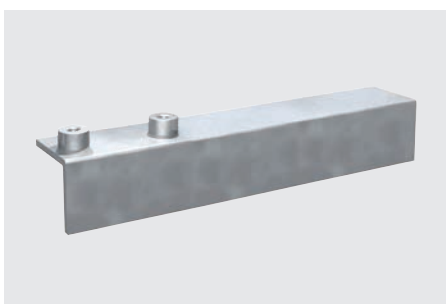

H



## Enquiry Form for Custom-Designed Special Clamps

Please use the following form as a guideline when preparing an enquiry for a custom-designed special clamp. Scan or copy the page from the catalogue, print and complete it

with as much information as possible, before sending it by email or fax to the closest STAUFF branch office. If possible, please also provide a sketch / drawing and let us know the

quantities required, and if the enquiry is for a one-time or recurring demand. We look forward to hearing from you, and are always available for consultation, when required.

### Application Information

**Area of use**  Indoor  Outdoor

**Ambient temperature** Lowest \_\_\_\_\_  °C /  °F Highest \_\_\_\_\_  °C /  °F

**Resistance against particular media**  No  Yes  Mineral oils  
 Other oils \_\_\_\_\_  
 Benzine  
 Weak acids  
 Solvents  
 Alcohols  
 Seawater  
 Other media \_\_\_\_\_

**Fire protection requirements**  No  Yes  UL94  
 BS 6853  
 Other standard \_\_\_\_\_

**Material preference for the clamp body**  Polypropylene  Polyamide  
 Aluminium  Steel  
 Stainless Steel  V2A  V4A  Other material \_\_\_\_\_

### Design Information

**Type of line**  Pipe / tube (fixed installation)  Pipe / tube (sliding installation)  
 Hose  Conduit Hose  
 Cable  Mix of different types of lines  
 Other components \_\_\_\_\_

**Maximum dimensions of clamp body** Length \_\_\_\_\_ x Width \_\_\_\_\_ x Height \_\_\_\_\_  mm /  inch

**Total number of lines** \_\_\_\_\_

**Diameters per line**

Line 1 _____ <input type="checkbox"/> mm / <input type="checkbox"/> inch	Further comments _____
Line 2 _____ <input type="checkbox"/> mm / <input type="checkbox"/> inch	Further comments _____
Line 3 _____ <input type="checkbox"/> mm / <input type="checkbox"/> inch	Further comments _____
Line 4 _____ <input type="checkbox"/> mm / <input type="checkbox"/> inch	Further comments _____
Line 5 _____ <input type="checkbox"/> mm / <input type="checkbox"/> inch	Further comments _____
Line 6 _____ <input type="checkbox"/> mm / <input type="checkbox"/> inch	Further comments _____
Line 7 _____ <input type="checkbox"/> mm / <input type="checkbox"/> inch	Further comments _____
Line 8 _____ <input type="checkbox"/> mm / <input type="checkbox"/> inch	Further comments _____

**Preferred centre distance of the lines** \_\_\_\_\_  mm /  inch

**Preferred number of screw holes** \_\_\_\_\_

### Information on Mounting Hardware

**Preferred type of bolts**  Hexagon head bolts (with cover plate)  with metric threads  with UNC threads  
 Socket cap crews (with cover plate)  with metric threads  with UNC threads  
 Socket cap crews (w/o cover plate)  with metric threads  with UNC threads

**Preferred type of installation**  Welding (using a weld plate)  Welding (using weld studs)  
 Direct screw-fastening  Adhesive bonded fastening  
 Mounting rail (using a rail nut / adaptor)

**Material preference for the hardware**  Steel  Stainless Steel  V2A  V4A



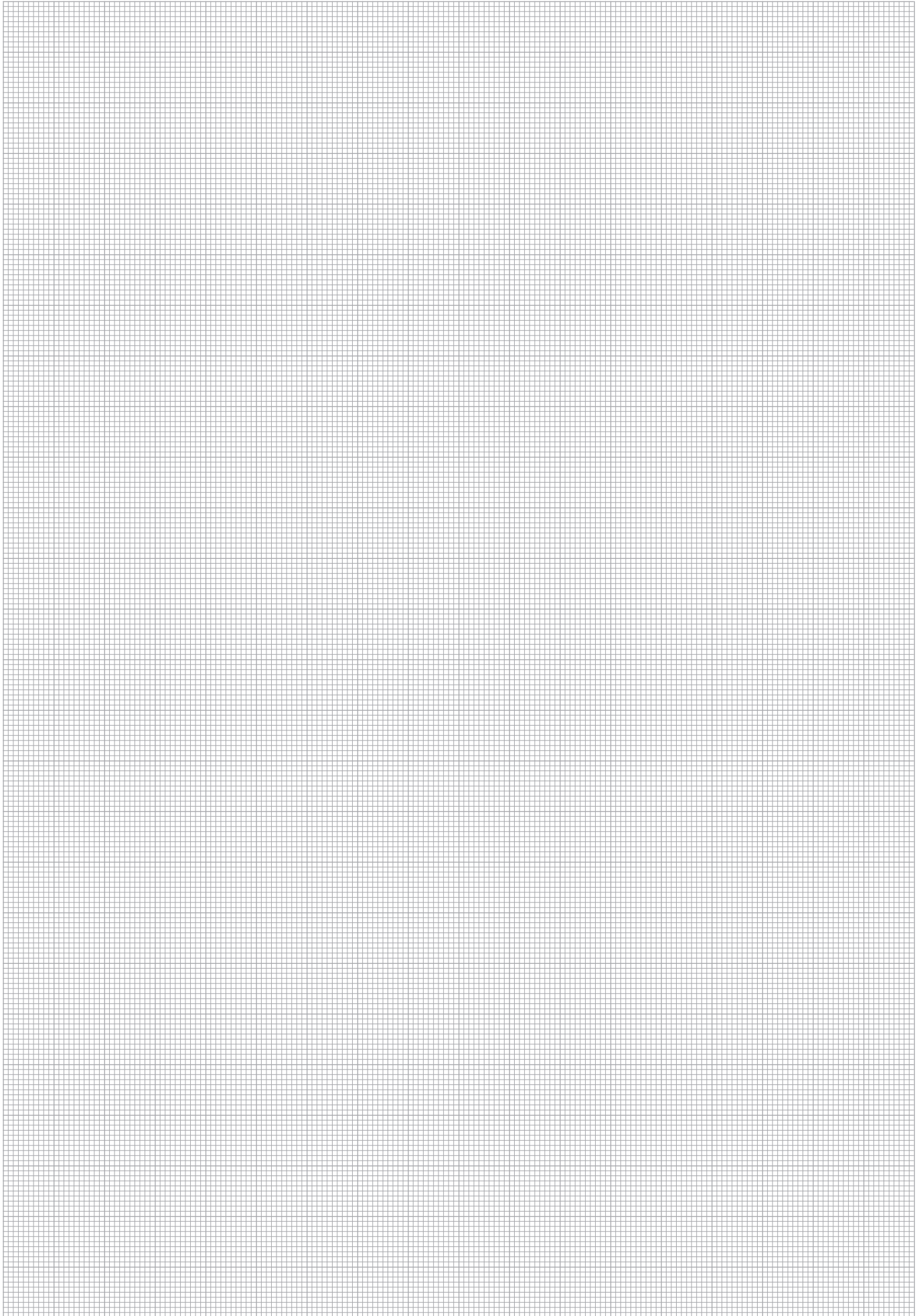











H





	<b>Clamp Body - Single Design</b> LBBU	112
	<b>Clamp Body - Twin Design</b> LBBU	113
	<b>Weld Plate</b> LBBU-SP	114
	<b>Sleeve</b> LBBU-HUE	114
	<b>Cover Plate</b> LBBU-DP	115
	<b>Hexagon Head Bolt</b> AS	115
	<b>Clamp Body - Single Design</b> LB	116
	<b>Clamp Body - Twin Design</b> LBG / LBU	117
	<b>Clamp Body - Single Design</b> LN	118
	<b>Clamp Body - Twin Design</b> LNGF / LNUF	119
	<b>Cover Plate</b> DPL	119



## Clamp Body - Single Design Type LBBU

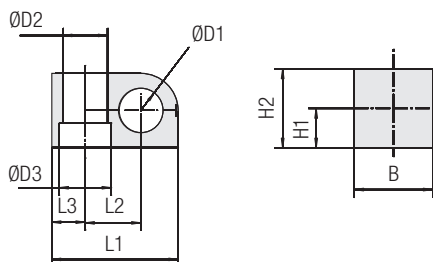

### Ordering Codes

**Clamp Body** \*LBBU-\*1\*06-\*SA-\*M8/U5/16

- \* Light Series LBBU **LBBU**
- \* STAUFF Group **1**
- \* Exact outside diameter Ø D1 (mm) **06**
- \* Material code (see below) **SA**
- \* Thread code (suitable for bolts M8 and U5/16) **M8/U5/16**

### Standard Materials



**Thermoplastic Elastomer** (87 Shore-A)  
Colour: Black  
Material code: **SA**

See pages 154 / 155 for material properties and technical information.

Alternative materials are available upon request.  
Please contact STAUFF for further information.

### Product Features

- Compact and light-weight design for applications in which space is limited
- Available in 3 different sizes and covering all standard metric and imperial diameters between 4 mm and 32 mm
- Vibration-damping and noise-reducing clamp body material with UV, ozone and weathering-resistant characteristics
- Advanced design with a film hinge allows the top part of the Plastic clamp body to open up and insert or replace the pipe, tube or hose without the use of force
- Embedded metal sleeve to ensure stability of the clamp assembly

Group	Outside Diameter Pipe / Tube / Hose Ø D1		Nominal Bore Pipe (in)	Ordering Codes (1 Clamp Body)	Dimensions (mm/in)											
	(mm)	(in)			Ø D2	Ø D3	L1	L2	L3	H1	H2	B				
1	6			LBBU-106-SA-M8/U5/16												
	6,4	1/4		LBBU-106.4-SA-M8/U5/16												
	8	5/16		LBBU-108-SA-M8/U5/16												
	9,5	3/8		LBBU-109.5-SA-M8/U5/16	12	14	34	15	9	10	20	20				
	10		1/8	LBBU-110-SA-M8/U5/16	.47	.55	1.34	.59	.35	.39	.79	.79				
	11			LBBU-111-SA-M8/U5/16												
	12			LBBU-112-SA-M8/U5/16												
	12,7	1/2		LBBU-112.7-SA-M8/U5/16												
	2	4			LBBU-204-SA-M8/U5/16											
		6			LBBU-206-SA-M8/U5/16											
6,4		1/4		LBBU-206.4-SA-M8/U5/16												
8		5/16		LBBU-208-SA-M8/U5/16												
9,5		3/8		LBBU-209.5-SA-M8/U5/16												
10			1/8	LBBU-210-SA-M8/U5/16												
11				LBBU-211-SA-M8/U5/16												
12				LBBU-212-SA-M8/U5/16	12	14	39	18	9	12	24	20				
12,7		1/2		LBBU-212.7-SA-M8/U5/16	.47	.55	1.54	.71	.35	.47	.94	.79				
13,5			1/4	LBBU-213.5-SA-M8/U5/16												
14				LBBU-214-SA-M8/U5/16												
15				LBBU-215-SA-M8/U5/16												
16		5/8		LBBU-216-SA-M8/U5/16												
17,2			3/8	LBBU-217.2-SA-M8/U5/16												
18			LBBU-218-SA-M8/U5/16													
19	3/4		LBBU-219-SA-M8/U5/16													
20			LBBU-220-SA-M8/U5/16													
3	21,3			LBBU-321.3-SA-M8/U5/16												
	22	7/8		LBBU-322-SA-M8/U5/16												
	23			LBBU-323-SA-M8/U5/16												
	25			LBBU-325-SA-M8/U5/16	12	14	57,5	23,5	15	20	40	30				
	25,4	1		LBBU-325.4-SA-M8/U5/16	.47	.55	2.26	.93	.59	.79	1.57	1.18				
	28			LBBU-328-SA-M8/U5/16												
	30			LBBU-330-SA-M8/U5/16												
	32	1-1/4		LBBU-332-SA-M8/U5/16												

Additional outside diameters are available upon request. Please contact STAUFF for further information.



**Type of Mounting SP**  
(with Weld Plate LBBU-SP)

Clamp assembly consisting of:

- 1 Hexagon Head Bolt AS
- 1 Cover Plate LBBU-DP
- 1 Sleeve LBBU-HUE
- 1 Clamp Body LBBU
- 1 Weld Plate LBBU-SP

#### Order Code

**LBBU-SP-216-SA-DP-AS-M8-W10**

**W10** (Weld Plate made of Carbon Steel, phosphated; Other metal parts made of Carbon Steel, zinc/nickel-plated) is the standard option for this type of installation.

For UNC threads / bolts, please replace M8 by U5/16.



**Type of Mounting SM**  
(with Hexagon Rail Nut SM-2-5D)

Clamp assembly consisting of:

- 1 Hexagon Head Bolt AS
- 1 Cover Plate LBBU-DP
- 1 Sleeve LBBU-HUE
- 1 Clamp Body LBBU
- 1 Hexagon Rail Nut SM-2-5D  
(for use with Mounting Rail TS, see page 24 for details)

**Order Code** (Mounting Rail TS not included.)  
**LBBU-SM-216-SA-DP-AS-M8-W3**

**W3** (Metal parts made of Carbon Steel, zinc/nickel-plated) is the standard option for this type of installation.

For UNC threads / bolts, please replace M8 by U5/16.



**Type of Mounting PM**  
(for panel mounting without  
Weld Plate or Hexagon Rail Nut)

Clamp assembly consisting of:

- 1 Hexagon Head Bolt AS
- 1 Cover Plate LBBU-DP
- 1 Sleeve LBBU-HUE
- 1 Clamp Body LBBU

**Order Code**  
**LBBU-PM-216-SA-DP-AS-M8-W3**

**W3** (Metal parts made of Carbon Steel, zinc/nickel-plated) is the standard option for this type of installation.

For UNC threads / bolts, please replace M8 by U5/16.

Alternative sizes (e.g. for bolts M6 and 1/4–20 UNC), materials and surface finishings are available upon request.

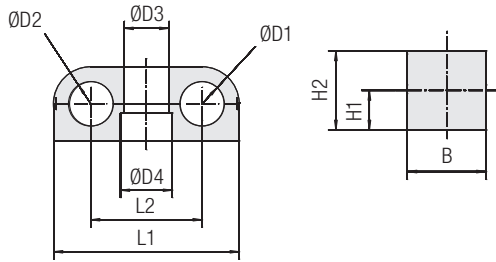

**Clamp Body - Twin Design  
Type LBBU**

Group	Outside Diameters Pipe / Tube / Hose Ø D1 / Ø D2	Nominal Bore Pipe	Ordering Codes (1 Clamp Body)	Dimensions (mm/in)							
				Ø D3	Ø D4	L1	L2	H1	H2	B	
1D	4		LBBU-104/04-SA-M8/U5/16								
	6		LBBU-106/06-SA-M8/U5/16								
	6,4	1/4	LBBU-106.4/06.4-SA-M8/U5/16								
	8	5/16	LBBU-108/08-SA-M8/U5/16								
	9,5	3/8	LBBU-109.5/09.5-SA-M8/U5/16	12	14	50	30	10	20	20	
	10		LBBU-110/10-SA-M8/U5/16	.47	.55	1.97	1.18	.39	.79	.79	
	11		LBBU-111/11-SA-M8/U5/16								
	12		LBBU-112/12-SA-M8/U5/16								
2D	12,7	1/2	LBBU-112.7/12.7-SA-M8/U5/16								
	4		LBBU-204/04-SA-M8/U5/16								
	6		LBBU-206/06-SA-M8/U5/16								
	8	5/16	LBBU-208/08-SA-M8/U5/16								
	9,5	3/8	LBBU-209.5/9.5-SA-M8/U5/16								
	10		LBBU-210/10-SA-M8/U5/16								
	11		LBBU-211/11-SA-M8/U5/16								
	12		LBBU-212/12-SA-M8/U5/16								
	12,7	1/2	LBBU-212.7/12.7-SA-M8/U5/16	12	14	59	35	12	24	20	
	13,5	1/4	LBBU-213.5/13.5-SA-M8/U5/16	.47	.55	2.32	1.38	.47	.94	.79	
	14		LBBU-214/14-SA-M8/U5/16								
	15		LBBU-215/15-SA-M8/U5/16								
3D	16	5/8	LBBU-216/16-SA-M8/U5/16								
	17,2	3/8	LBBU-217.2/17.2-SA-M8/U5/16								
	18		LBBU-218/18-SA-M8/U5/16								
	19	3/4	LBBU-219/19-SA-M8/U5/16								
	20		LBBU-220/20-SA-M8/U5/16								
	21,3		LBBU-321.321.3-SA-M8/U5/16								
	22	7/8	LBBU-322/22-SA-M8/U5/16								
	23		LBBU-323/23-SA-M8/U5/16								
25		LBBU-325/25-SA-M8/U5/16	12	14	86	47	20	40	30		
25,4	1	LBBU-325.4/25.4-SA-M8/U5/16	.47	.55	3.39	1.85	.79	1.57	.79		
28		LBBU-328/28-SA-M8/U5/16									
30		LBBU-330/30-SA-M8/U5/16									
32	1-1/4	LBBU-332/32-SA-M8/U5/16									

**Ordering Codes**
**Clamp Body \*LBBU-\*1\*06/06-\*SA-\*M8/U5/16**

- \* Light Series LBBU **LBBU**
- \* 1st Part of STAUFF Group **1**
- \* Exact outside diameters Ø D1 / Ø D2 (mm) **06/06**
- \* Material code (see below) **SA**
- \* Thread code (suitable for bolts M8 and U5/16) **M8/U5/16**

**Standard Materials**

**Thermoplastic Elastomer** (87 Shore-A)  
Colour: Black  
Material code: **SA**

See pages 154 / 155 for material properties and technical information.

Alternative materials are available upon request. Please contact STAUFF for further information.

**Product Features**

- Compact and light-weight design for applications in which space is limited
- Available in 3 different sizes and covering all standard metric and imperial diameters between 4 mm and 32 mm
- Vibration-damping and noise-reducing clamp body material with UV, ozone and weathering-resistant characteristics
- Advanced design with a film hinge allows the top part of the Plastic clamp body to open up and insert or replace the pipe, tube or hose without the use of force
- Embedded metal sleeve to ensure stability of the clamp assembly

Additional outside diameters and combinations of different outside diameters are available upon request. Please contact STAUFF for further information.

**Type of Mounting SP**  
(with Weld Plate LBBU-SP)

Clamp assembly consisting of:

- 1 Hexagon Head Bolt AS
- 1 Cover Plate LBBU-DP
- 1 Sleeve LBBU-HUE
- 1 Clamp Body LBBU
- 1 Weld Plate LBBU-SP

**Order Code**  
**LBBU-SP-216/16-SA-DP-AS-M8-W10**

**W10** (Weld Plate made of Carbon Steel, phosphated; Other metal parts made of Carbon Steel, zinc/nickel-plated) is the standard option for this type of installation.  
For UNC threads / bolts, please replace M8 by U5/16.

**Type of Mounting SM**  
(with Hexagon Rail Nut SM-2-5D)

Clamp assembly consisting of:

- 1 Hexagon Head Bolt AS
- 1 Cover Plate LBBU-DP
- 1 Sleeve LBBU-HUE
- 1 Clamp Body LBBU
- 1 Hexagon Rail Nut SM-2-5D (for use with Mounting Rail TS, see page 24 for details)

**Order Code** (Mounting Rail TS not included.)  
**LBBU-SM-216/16-SA-DP-AS-M8-W3**

**W3** (Metal parts made of Carbon Steel, zinc/nickel-plated) is the standard option for this type of installation.  
For UNC threads / bolts, please replace M8 by U5/16.

**Type of Mounting PM**  
(for panel mounting without Weld Plate or Hexagon Rail Nut)

Clamp assembly consisting of:

- 1 Hexagon Head Bolt AS
- 1 Cover Plate LBBU-DP
- 1 Sleeve LBBU-HUE
- 1 Clamp Body LBBU

**Order Code**  
**LBBU-PM-216/16-SA-DP-AS-M8-W3**

**W3** (Metal parts made of Carbon Steel, zinc/nickel-plated) is the standard option for this type of installation.  
For UNC threads / bolts, please replace M8 by U5/16.

Alternative sizes (e.g. for bolts M6 and 1/4–20 UNC), materials and surface finishings are available upon request.



## Weld Plate Type LBBU-SP

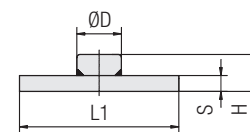
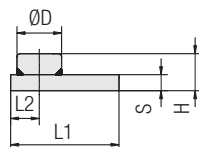
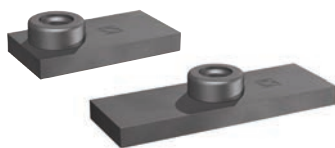

STAUFF Group 1 to 3

STAUFF Group 1D to 3D

### Ordering Codes

#### Weld Plate **\*LBBU-SP-\*1D-\*M8-\*W2**

- \* Light Series LBBU **LBBU**
- \* Weld Plate **-SP**
- \* STAUFF Group **1D**
- \* Thread code Metric ISO thread: M8 **M8**  
UNC thread: 5/16-18 UNC **U5/16**
- \* Material code Carbon Steel, phosphated **W2**

Group STAUFF	Dimensions (mm/in)					Thread G	Ordering Codes (Standard Options)
	Ø D	L1	L2	H	S		
1	14	34	9	10,3	5	M8	LBBU-SP-1-M8-W2
	.55	1.34	.35	.41	.20	5/16-18 UNC	LBBU-SP-1-U5/16-W2
2	14	39	9	10,3	5	M8	LBBU-SP-2-M8-W2
	.55	1.54	.35	.41	.20	5/16-18 UNC	LBBU-SP-2-U5/16-W2
3	14	57,5	15	10,3	5	M8	LBBU-SP-3-M8-W2
	.55	2.26	.59	.41	.20	5/16-18 UNC	LBBU-SP-3-U5/16-W2
1D	14	50	X	10,3	5	M8	LBBU-SP-1D-M8-W2
	.55	1.97		.41	.20	5/16-18 UNC	LBBU-SP-1D-U5/16-W2
2D	14	59		10,3	5	M8	LBBU-SP-2D-M8-W2
	.55	2.32		.41	.20	5/16-18 UNC	LBBU-SP-2D-U5/16-W2
3D	14	86	10,3	5	M8	LBBU-SP-3D-M8-W2	
	.55	3.39	.41	.20	5/16-18 UNC	LBBU-SP-3D-U5/16-W2	

All threaded parts are available with Metric ISO thread or unified coarse (UNC) thread according to dimension table. Alternative sizes (e.g. for bolts M6 and 1/4-20 UNC), materials and surface finishings are available upon request.

## Sleeve Type LBBU-HUE

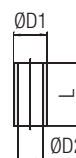

Dimensions applicable only when used with Weld Plate LBBU-SP (**Type of Mounting SP**)

Dimensions applicable only when used with Hexagon Rail Nut SM-2-5D (**Type of Mounting SM**)

Dimensions applicable only when used for panel mounting without Weld Plate or Hexagon Rail Nut (**Type of Mounting PM**)

Group STAUFF	Dimensions (mm/in)			Ordering Codes (Standard Options)
	ØD1	ØD2	L	
1	12	9	13,5	LBBU-HUE-1/1D-SP-M8/U5/16-W3
	.47	.35	.53	
2	12	9	17,5	LBBU-HUE-2/2D-SP-M8/U5/16-W3
	.47	.35	.69	
3	12	9	33,5	LBBU-HUE-3/3D-SP-M8/U5/16-W3
	.47	.35	1.32	
1D	12	9	13,5	LBBU-HUE-1/1D-SP-M8/U5/16-W3
	.47	.35	.53	
2D	12	9	17,5	LBBU-HUE-2/2D-SP-M8/U5/16-W3
	.47	.35	.69	
3D	12	9	33,5	LBBU-HUE-3/3D-SP-M8/U5/16-W3
	.47	.35	1.32	

Group STAUFF	Dimensions (mm/in)			Ordering Codes (Standard Options)
	ØD1	ØD2	L	
1	12	9	12,8	LBBU-HUE-1/1D-SM-M8/U5/16-W3
	.47	.35	.50	
2	12	9	16,8	LBBU-HUE-2/2D-SM-M8/U5/16-W3
	.47	.35	.66	
3	12	9	32,8	LBBU-HUE-3/3D-SM-M8/U5/16-W3
	.47	.35	1.29	
1D	12	9	12,8	LBBU-HUE-1/1D-SM-M8/U5/16-W3
	.47	.35	.50	
2D	12	9	16,8	LBBU-HUE-2/2D-SM-M8/U5/16-W3
	.47	.35	.66	
3D	12	9	32,8	LBBU-HUE-3/3D-SM-M8/U5/16-W3
	.47	.35	1.29	

Group STAUFF	Dimensions (mm/in)			Ordering Codes (Standard Options)
	ØD1	ØD2	L	
1	12	9	18,8	LBBU-HUE-1/1D-PM-M8/U5/16-W3
	.47	.35	.74	
2	12	9	22,7	LBBU-HUE-2/2D-PM-M8/U5/16-W3
	.47	.35	.89	
3	12	9	38,8	LBBU-HUE-3/3D-PM-M8/U5/16-W3
	.47	.35	1.53	
1D	12	9	18,8	LBBU-HUE-1/1D-PM-M8/U5/16-W3
	.47	.35	.74	
2D	12	9	22,7	LBBU-HUE-2/2D-PM-M8/U5/16-W3
	.47	.35	.89	
3D	12	9	38,8	LBBU-HUE-3/3D-PM-M8/U5/16-W3
	.47	.35	1.53	

Alternative sizes (e.g. for bolts M6 and 1/4-20 UNC), materials and surface finishings are available upon request.



Cover Plate  
Type LBBU-DP

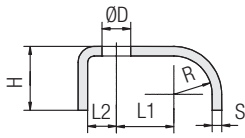

STAUFF Group 1 to 3

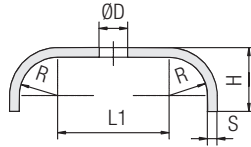

STAUFF Group 1D to 3D



Group STAUFF	Dimensions (mm/in)						Ordering Codes (Standard Options)
	Ø D	L1	L2	R	H	S	
1	9	15	9	10	16	3	LBBU-DP-1-M8/U5/16-W3
	.35	.59	.35	.39	.63	.12	
2	9	18	9	12	20	3	LBBU-DP-2-M8/U5/16-W3
	.35	.71	.35	.47	.79	.12	
3	9	23,5	15	19,5	28	3	LBBU-DP-3-M8/U5/16-W3
	.35	.93	.59	.77	1.10	.12	
1D	9	30	X	10	16	3	LBBU-DP-1D-M8/U5/16-W3
	.35	1.18		.39	.63	.12	
2D	9	35		12	20	3	LBBU-DP-2D-M8/U5/16-W3
	.35	1.38		.47	.79	.12	
3D	9	47	19,5	28	3	LBBU-DP-3D-M8/U5/16-W3	
	.35	1.85	.77	.63	.12		

Ordering Codes

Cover Plate \*LBBU-DP-\*1D-\*M8/U5/16-\*W3

- \* Light Series LBBU LBBU
- \* Cover Plate -DP
- \* STAUFF Group 1D
- \* Thread code (suitable for bolts M8 and U5/16) M8/U5/16
- \* Material code Carbon Steel, zinc/nickel-plated W3

Alternative sizes (e.g. for bolts M6 and 1/4-20 UNC), materials and surface finishings are available upon request.

Hexagon Head Bolt  
Type AS

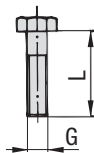

Hexagon Head Bolt AS

(according to DIN 931 / 933 or ANSI / ASME B18.2.1.)  
Dimensions applicable only when used with  
Weld Plate LBBU-SP (Type of Mounting SP)  
or Hexagon Rail Nut SM-2-5D (Type of Mounting SM)

Hexagon Head Bolt AS

(according to DIN 931 / 933 or ANSI / ASME B18.2.1.)  
Dimensions applicable only when used for panel mounting  
without Weld Plate or Hexagon Rail Nut  
(Type of Mounting PM)



Group STAUFF	Dimensions (mm/in)		Ordering Codes (Standard Options)
	Thread	G x L	
1	M8 x 25	AS-M8x25-W3	AS-U5/16-18x1-W3
	5/16-18 UNC x 1	AS-U5/16-18x1-1/8-W3	
2	M8 x 28	AS-M8x28-W3	AS-U5/16-18x1-1/8-W3
	5/16-18 UNC x 1-1/8	AS-U5/16-18x1-3/4-W3	
3	M8 x 45	AS-M8x45-W3	AS-U5/16-18x1-3/4-W3
	5/16-18 UNC x 1-3/4	AS-U5/16-18x1-3/4-W3	
1D	M8 x 25	AS-M8x25-W3	AS-U5/16-18x1-W3
	5/16-18 UNC x 1	AS-U5/16-18x1-W3	
2D	M8 x 28	AS-M8x28-W3	AS-U5/16-18x1-1/8-W3
	5/16-18 UNC x 1-1/8	AS-U5/16-18x1-3/4-W3	
3D	M8 x 45	AS-M8x45-W3	AS-U5/16-18x1-3/4-W3
	5/16-18 UNC x 1-3/4	AS-U5/16-18x1-3/4-W3	

Group STAUFF	Dimensions (mm/in)		Ordering Codes (Standard Options)
	Thread	G x L	
1	M8 x 30	AS-M8x30-W3	AS-U5/16-18x1-1/4-W3
	5/16-18 UNC x 1-1/4	AS-U5/16-18x1-3/8-W3	
2	M8 x 35	AS-M8x35-W3	AS-U5/16-18x1-3/8-W3
	5/16-18 UNC x 1-3/8	AS-U5/16-18x2-W3	
3	M8 x 50	AS-M8x50-W3	AS-U5/16-18x2-W3
	5/16-18 UNC x 2	AS-U5/16-18x2-W3	
1D	M8 x 30	AS-M8x30-W3	AS-U5/16-18x1-1/4-W3
	5/16-18 UNC x 1-1/4	AS-U5/16-18x1-3/8-W3	
2D	M8 x 35	AS-M8x35-W3	AS-U5/16-18x1-3/8-W3
	5/16-18 UNC x 1-3/8	AS-M8x50-W3	
3D	M8 x 50	AS-M8x50-W3	AS-U5/16-18x2-W3
	5/16-18 UNC x 2	AS-U5/16-18x2-W3	

Ordering Codes

Hexagon Head Bolt \*AS-\*M8x25-\*W3

- \* Type of bolt Hexagon Head Bolt (according to DIN 931 / 933 or ANSI / ASME B18.2.1.) AS
- \* Thread code Thread dimension according to dimension table M8x25
- \* Material code Carbon Steel, zinc/nickel-plated W3

All threaded parts are available with Metric ISO thread or unified coarse (UNC) thread according to dimension table.  
Alternative sizes (e.g. for bolts M6 and 1/4-20 UNC), materials and surface finishings are available upon request.



## Clamp Body - Single Design Type LB

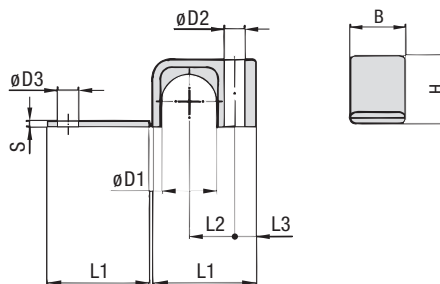

### Ordering Codes

#### Clamp Body

**\*LB-\*1\*03.2-\*PP**

- \* Light Series: Clamp Body / Single Design **LB**
- \* STAUFF Group **1**
- \* Exact outside diameter Ø D1 (mm) **03.2**
- \* Material code (see below) **PP**

### Standard Materials



**Polypropylene**  
Colour: Black  
Material code: **PP**



**Polyamide**  
Colour: Yellow  
Material code: **PA**

See pages 154 / 155 for material properties and technical information.

Alternative materials are available upon request.  
Please contact STAUFF for further information.

### Applications

- Pneumatics, Instrumentation and Automotive Technology,  
Machine Tool Industry, Lubrication, Mechanical Engineering

Group	Outside Diameter		Nominal Bore Pipe (in)	Ordering Codes (1 Clamp Body) (** = Material)	Dimensions (mm/in)								
	Pipe / Tube / Hose Ø D1 (mm)	(in)			L1	L2	L3	B	H	S	Ø D2	Ø D3	
1	3,2	1/8		LB-103.2-**-**									
	6			LB-106-**-**	22	9	6,5	12	10,5	2	6,8	7	
	6,4	1/4		LB-106.4-**-**	.87	.35	.26	.47	.41	.08	.27	.28	
	8			LB-108-**-**									
2	9,5	3/8		LB-209.5-**-**									
	10		1/8	LB-210-**-**	27	11	7	16	15	2	6,8	7	
	11,1			LB-211.1-**-**	1.06	.43	.28	.63	.59	.08	.27	.28	
	12			LB-212-**-**									
3	12,7	1/2		LB-312.7-**-**									
	13,5		1/4	LB-313.5-**-**									
	14			LB-314-**-**									
	15			LB-315-**-**	34	15	7	20	22,5	2	6,8	7	
	16	5/8		LB-316-**-**	1.34	.59	.28	.79	.89	.08	.27	.28	
	17,2		3/8	LB-317.2-**-**									
4	18			LB-318-**-**									
	19	3/4		LB-419-**-**									
	20			LB-420-**-**									
	21,3		1/2	LB-421.3-**-**	42	19	7	20	30	2	6,8	7	
	22			LB-422-**-**	1.65	.75	.28	.79	1.18	.08	.27	.28	
	25			LB-425-**-**									
	25,4	1		LB-425.4-**-**									

Additional outside diameters are available upon request. Please contact STAUFF for further information.

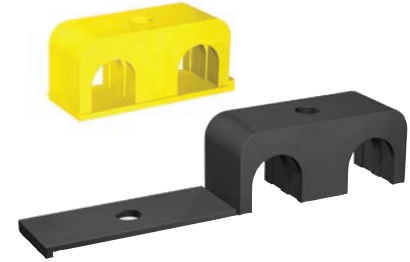
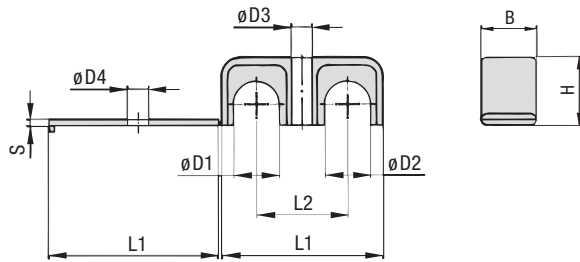

**Clamp Body - Twin Design  
Types LBG / LBU**

Group	Outside Diameters		Nominal Bore Pipe (in)	Ordering Codes (1 Clamp Body) (** = Material)	Dimensions (mm/in)						
	Pipe / Tube / Hose Ø D1 / Ø D2 (mm)	(in)			L1	L2	B	H	S	Ø D3	Ø D4
1	3,2	1/8		LBG-103.2/03.2-**							
	6			LBG-106/06-**	31	18	12	10,5	2	6,8	7
	6,4	1/4		LBG-106.4/06.4-**	1.22	.71	.47	.41	.08	.27	.28
	8			LBG-108/08-**							
2	9,5	3/8		LBG-209.5/09.5-**							
	10		1/8	LBG-210/10-**	39	22	16	15	2	6,8	7
	11,1			LBG-211.1/11.1-**	1.54	.87	.63	.59	.08	.27	.28
	12			LBG-212/12-**							
3	12,7	1/2		LBG-312.7/12.7-**							
	13,5		1/4	LBG-313.5/13.5-**							
	14			LBG-314/14-**							
	15			LBG-315/15-**	53	30	20	22,5	2	6,8	7
	16	5/8		LBG-316/16-**	2.09	1.18	.79	.89	.08	.27	.28
	17,2		3/8	LBG-317.2/17.2-**							
4	18			LBG-318/18-**							
	19	3/4		LBG-419/19-**							
	20			LBG-420/20-**							
	21,3		1/2	LBG-421.3/21.3-**	70	38	20	30	2	6,8	7
	22			LBG-422/22-**	2.76	1.50	.79	1.18	.08	.27	.28
	25			LBG-425/25-**							
	25,4	1		LBG-425.4/25.4-**							

**Ordering Codes**
**Clamp Body \*LBG-\*1\*03.2/03.2-\*PP**

- \* Light Series: Clamp Body / Twin Design with identical diameters **LBG**
- Clamp Body / Twin Design with different diameters **LBU**
- \* STAUFF Group **1**
- \* Exact outside diameters Ø D1 / Ø D2 (mm) **03.2/03.2**
- \* Material code (see below) **PP**

**Standard Materials**

**Polypropylene**  
 Colour: Black  
 Material code: **PP**

**Polyamide**  
 Colour: Yellow  
 Material code: **PA**

See pages 154 / 155 for material properties and technical information.

Alternative materials are available upon request. Please contact STAUFF for further information.

**Applications**

- Pneumatics, Instrumentation and Automotive Technology, Machine Tool Industry, Lubrication, Mechanical Engineering

Additional outside diameters and combinations of different outside diameters (Clamp Body, Type LBU) are available upon request. Please contact STAUFF for further information.



## Clamp Body - Single Design Type LN

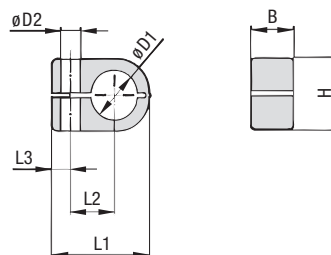
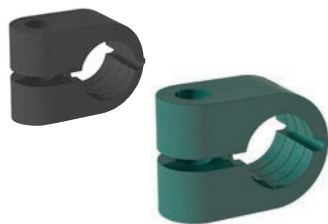

### Ordering Codes

#### Clamp Body

**\*LN-\*1\*06-\*PP**

- \* Light Series: Clamp Body / Single Design **LN**
- \* STAUFF Group **1**
- \* Exact outside diameter Ø D1 (mm) **06**
- \* Material code (see below) **PP**

### Standard Materials



#### Polypropylene

Colour: Green  
Material code: **PP**



#### Polyamide

Colour: Black  
Material code: **PA**

See pages 154 / 155 for material properties and technical information.

Alternative materials are available upon request.  
Please contact STAUFF for further information.

### Applications

- Pneumatics, Instrumentation and Automotive Technology, Machine Tool Industry, Lubrication, Mechanical Engineering

Group	Outside Diameter Pipe / Tube / Hose Ø D1		Nominal Bore Pipe (in)	Ordering Codes (1 Clamp Body) (* = Material)	Dimensions (mm/in)					
	(mm)	(in)			L1	L2	L3	B	H	Ø D2
1	6			LN-106-*	22	9	7	14,5	13,5	6,8
	6,4	1/4		LN-106.4-*	.87	.35	.28	.57	.53	.27
	8			LN-108-*						
2	8			LN-208-*						
	9,5	3/8		LN-209.5-*	27	11	7	14,5	18,5	6,8
	10		1/8	LN-210-*	1.06	.43	.28	.57	.59	.27
	12			LN-212-*						
3	12,7	1/2		LN-212.7-*						
	10		1/8	LN-310-*						
	12			LN-312-*						
	12,7	1/2		LN-312.7-*	33	15	7	14,5	23,5	6,8
	13,5		1/4	LN-313.5-*	1.30	.59	.28	.57	.93	.27
	14			LN-314-*						
4	15			LN-315-*						
	16	5/8		LN-316-*						
	14			LN-414-*						
	15			LN-415-*						
	16	5/8		LN-416-*						
	17,2		3/8	LN-417.2-*	40	19	7	14,5	30,5	6,8
	18			LN-418-*	1.57	.75	.28	.57	1.20	.27
	19	3/4		LN-419-*						
20			LN-420-*							
21,3		1/2	LN-421.3-*							
22			LN-422-*							

Additional outside diameters are available upon request. Please contact STAUFF for further information.

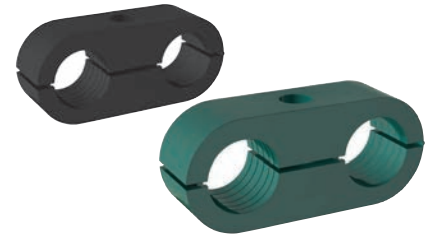
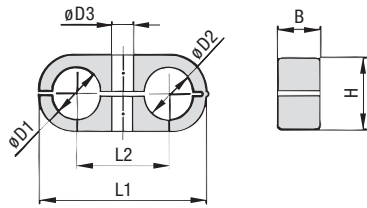

**Clamp Body - Twin Design  
Type LNGF / LNUF**

Group STAUFF	Outside Diameters Pipe / Tube / Hose Ø D1 / Ø D2		Nominal Bore Pipe (in)	Ordering Codes (1 Clamp Body) (** = Material)	Dimensions (mm/in)				
	(mm)	(in)			L1	L2	B	H	Ø D3
1	6			LNGF-106/06-**	32	18	14,5	13,5	6,8
	6,4	1/4		LNGF-106.4/06.4-**	1.26	.70	.57	.53	.27
	8			LNGF-108/08-**					
2	8			LNGF-208/08-**					
	9,5	3/8		LNGF-209.5/09.5-**					
	10		1/8	LNGF-210/10-**	41	22	14,5	18,5	6,8
	12			LNGF-212/12-**	1.61	.86	.57	.73	.27
	12,7	1/2		LNGF-212.7/12.7-**					
3	10		1/8	LNGF-310/10-**					
	12			LNGF-312/12-**					
	12,7	1/2		LNGF-312.7/12.7-**					
	13,5		1/4	LNGF-313.5/13.5-**	54	30	14,5	23,5	6,8
	14			LNGF-314/14-**	2.13	1.18	.57	.93	.27
	15			LNGF-315/15-**					
4	16	5/8		LNGF-316/16-**					
	14			LNGF-414/14-**					
	15			LNGF-415/15-**					
	16	5/8		LNGF-416/16-**					
	17,2		3/8	LNGF-417.2/17.2-**	70	38	14,5	30,5	6,8
	18			LNGF-418/18-**	2.76	1.50	.57	1.20	.27
	19	3/4		LNGF-419/19-**					
	20			LNGF-420/20-**					
21,3		1/2	LNGF-421.3/21.3-**						
22			LNGF-422/22-**						

**Ordering Codes**
**Clamp Body \*LNGF-\*1\*06/06-\*PP**

- \* Light Series: Clamp Body / Twin Design with identical diameters **LNGF**
- Clamp Body / Twin Design with different diameters **LNUF**
- \* STAUFF Group **1**
- \* Exact outside diameters Ø D1 / Ø D2 (mm) **06/06**
- \* Material code (see below) **PP**

**Standard Materials**
**Polypropylene**  
 Colour: Green  
 Material code: **PP**
**Polyamide**  
 Colour: Black  
 Material code: **PA**

See pages 154 / 155 for material properties and technical information. Alternative materials are available upon request. Please contact STAUFF for further information.

**Applications**

- Pneumatics, Instrumentation and Automotive Technology, Machine Tool Industry, Lubrication, Mechanical Engineering

Additional outside diameters and combinations of different outside diameters (Clamp Body, type LNUF) are available upon request. Please contact STAUFF for further information.

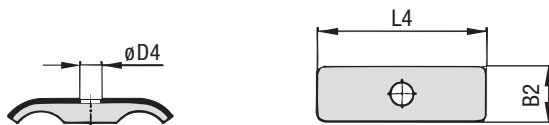
**Cover Plate  
Type DPL**

Group STAUFF	Dimensions (mm/in)			Ordering Codes (Standard Options)
	L4	B2	Ø D4	
1	29,5	15,5	6,8	DPL-1-W3
	1.16	.61	.27	
2	40	15,5	6,8	DPL-2-W3
	1.57	.61	.27	
3	51	16	6,8	DPL-3-W3
	2.01	.63	.27	
4	63,5	16	6,8	DPL-4-W3
	2.50	.63	.27	

**Ordering Codes**
**Cover Plate \*DPL-\*1-\*W3**

- \* Cover Plate for Clamp Body / Twin Design **DPL**
- \* STAUFF Group **1**
- \* Material code Carbon Steel, zinc/nickel-plated **W3**

Alternative materials and surface finishings are available upon request. Contact STAUFF for further information. Please note: The maximum tightening torque for bolts is 2,5 N·m (1.85 ft·lb).







**Saddle / Piggyback Clamp**

ZR-518

122



**Custom-Designed Saddle / Piggyback Clamps**

122



Saddle / Piggyback Clamps  
Type ZR

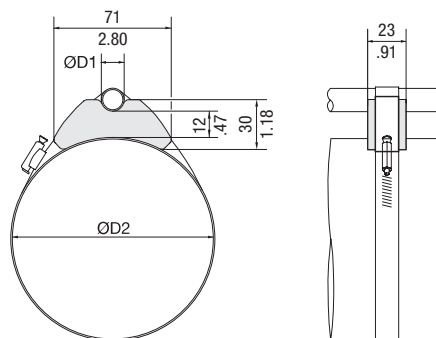

Order Code

Saddle Clamp

ZR-518-BK9005

Standard Material



Thermoplastic Elastomer (73 Shore-A)  
Colour: Black

See pages 154 / 155 for properties and technical information.

Min/Max Outside Diameters *				Tightening Strap Dimensions (Not Included in Scope of Delivery)			
Pipe / Tube Ø D1		Ø D2		Length		Width	
(mm)	(in)	(mm)	(in)	(mm)	(in)	(mm)	(in)
10 ... 22	.39 ... .87	50 ... 70	1.96 ... 2.76	196 ... 254	7.71 ... 10.00	13	.51
		60 ... 80	2.36 ... 3.15	225 ... 284	8.86 ... 11.18		
		70 ... 90	2.76 ... 3.54	254 ... 314	10.00 ... 12.36		
		80 ... 105	3.15 ... 4.13	284 ... 359	11.18 ... 14.13		
		90 ... 120	3.54 ... 4.72	314 ... 404	12.36 ... 15.90		
		105 ... 140	4.13 ... 5.51	359 ... 464	14.13 ... 18.27		
		125 ... 160	4.92 ... 6.30	419 ... 525	16.50 ... 20.66		
		145 ... 180	5.71 ... 7.09	479 ... 586	18.86 ... 23.07		
165 ... 200	6.50 ... 7.87	540 ... 647	21.26 ... 25.47				

\* Ø D1 depending on Ø D2!

J

Saddle / Piggyback Clamps

Type ZR saddle clamps from STAUFF allow direct fixing and safe guiding of pipes, tubes and hoses on hydraulic cylinders and other round or oval structures, without causing damage to their strength or integrity as with screw-fixing or welding and without preparation or reworking of the surface coating. The simple system also allows a pipe, tube or hose with a small outer diameter to be installed on top of a significantly larger one.

The position can be adjusted at any time thanks to free axial and radial positioning of the clamps on the structure. This also makes the system suitable for retrofitting.

The standard version ZR-518 made of thermoplastic elastomer material covers diameters in a range from 50 to 200 mm / 1.96 to 7.87 in for the cylinder and from 10 to 22 mm / .39 to .87 inch for the attached tube or hose. The diameters to be covered are used to calculate the overall length of the required tightening straps or the dimensions of the steel strap or worm drive hose clamp, e.g. according to DIN 3017.

STAUFF meets deviating requirements with numerous other variants which were implemented in the past and can be manufactured again at any time.

If required, customised clamps can be developed for specific requirements or manufactured based on drawings and models provided.

Please contact STAUFF for further information.



Dimensional drawings: All dimensions in mm (in).



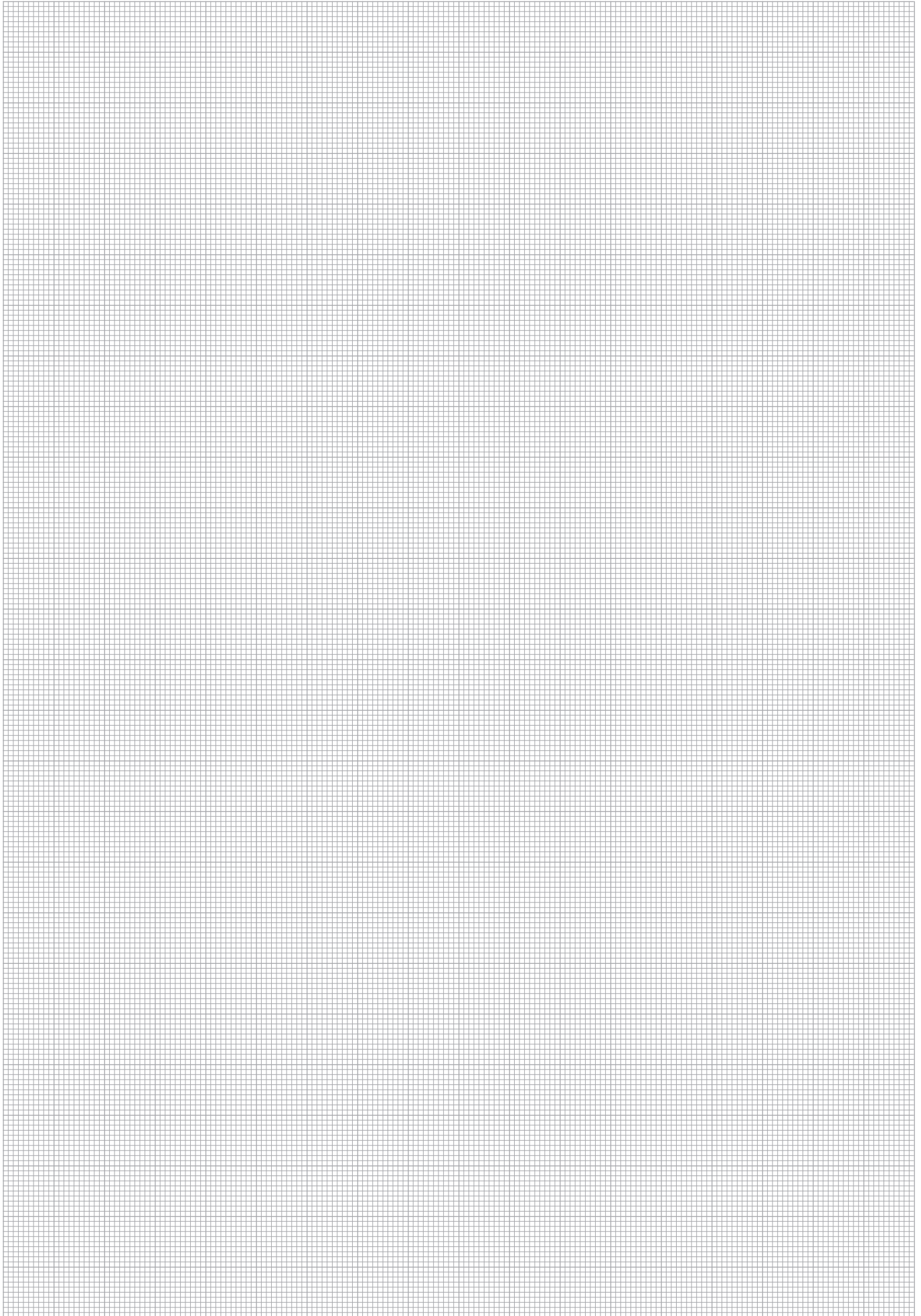

J







**Flat Steel U-Bolt  
with Plastic Pipe Saddle (Short) and U-Profile**  
FB / RUK

126



**Round Steel U-Bolt  
with Plastic Pipe Saddle (Short)**  
RB / RUK

128



**Round Steel U-Bolt  
with Plastic Pipe Saddle (Long)**  
RB / RUL

130



**Round Steel U-Bolt (DIN 3570, Type A)  
without Plastic Pipe Saddle**  
RBD

132



**Flat Steel U-Bolt with Plastic Pipe Saddle (Short) and U-Profile**  
**Type FB+RUK (To be used as Fixed Point Clamps only)**

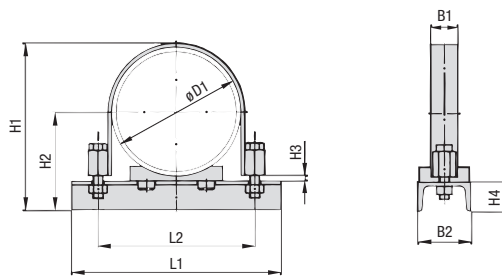
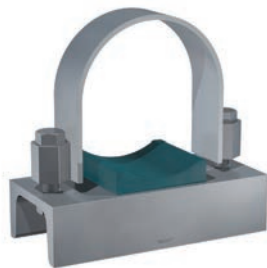

**Flat Steel U-Bolt (type FB) with Plastic Pipe Saddle (type RUK), U-Profile and Hexagon Head Bolts**

**Ordering Codes**

**Clamp Assembly \*FB+RUK-\*48.3-\*PP-\*W1**

One clamp assembly is consisting of one Flat Steel U-Bolt (type FB), one Plastic Pipe Saddle (type RUK), one U-Profile (to DIN 1026) with two Nuts (to DIN EN ISO 4032) and two Hexagon Head Bolts (to DIN EN ISO 4014 / 4017).

- \* Clamp Assembly (as listed above) **FB+RUK**
- \* Exact outside diameter Ø D1 (mm) **48.3**
- \* Material of Pipe Saddle (see below) **PP**
- \* Material code Carbon Steel, uncoated **W1**  
 Carbon Steel, zinc-plated, blue-chromated **W32**  
 Stainless Steel V4A 1.4401 / 1.4571 (AISI 316 / 316 Ti) **W5**

Please note: The U-Profile (to DIN 1026) is made of Carbon Steel, uncoated. All items are supplied non-assembled.

**Standard Materials for Plastic Pipe Saddles**



**Polypropylene**  
 Colour: Green  
 Material code: **PP**



**Polyamide**  
 Colour: Black  
 Material code: **PA**

See pages 154 / 155 for material properties and technical information.

Alternative materials are available upon request. Please contact STAUFF for further information.

**Applications**

- Standing or hanging installation of pipes and tubes on beams, profiles and consoles
- Design with two threaded ends allows for ideal adaptation to suit the exact outer diameter of the pipe or tube

Diameter Nominal DN	Outside Diameter Pipe / Tube Ø D1		Nominal Bore Pipe (in)	Dimensions (mm/m)						U-Profile (DIN 1026) B2 x H4
	(mm)	(in)		Flat Steel U-Bolt (Type FB)						
40	48,3	1.93	1-1/2	100	76	95	67	5	20 x 3	50 x 38
				3.94	2.99	3.74	2.64	.20	.78 x .12	1.97 x 1.50
50	57	2.28	2	115	85	103	71,5	5	20 x 3	50 x 38
				4.53	3.35	4.06	2.81	.20	.78 x .12	1.97 x 1.50
65	60,3	2.41	2	115	88	106	73,2	5	20 x 3	50 x 38
				4.53	3.46	4.17	2.88	.20	.78 x .12	1.97 x 1.50
80	76,1	3.04	2-1/2	132	104	122	81	5	20 x 3	50 x 38
				5.20	4.09	4.80	3.19	.20	.78 x .12	1.97 x 1.50
100	88,9	3.56	3	160	122	146	97,5	8	40 x 4	80 x 45
				6.30	4.80	5.75	3.84	.31	1.57 x .16	3.15 x 1.77
125	108	4.32	4	170	140	165	107	8	40 x 4	80 x 45
				6.69	5.51	6.50	4.21	.31	1.57 x .16	3.15 x 1.77
150	114,3	4.57	4	180	147	171	110	8	40 x 4	80 x 45
				7.09	5.79	6.73	4.33	.31	1.57 x .16	3.15 x 1.77
175	133	5.32	5	210	165	190	119,5	8	40 x 4	80 x 45
				8.27	6.50	7.48	4.70	.31	1.57 x .16	3.15 x 1.77
200	139,7	5.59	5	210	172	197	123	8	40 x 4	80 x 45
				8.27	6.77	7.76	4.84	.31	1.57 x .16	3.15 x 1.77
250	159	6.36	6	265	201	220	132,5	8	40 x 6	80 x 45
				1.43	7.91	8.66	5.22	.31	1.57 x .24	3.15 x 1.77
300	168,3	6.73	6	275	211	230	137	8	40 x 6	80 x 45
				1.83	8.31	9.06	5.39	.31	1.57 x .24	3.15 x 1.77
350	193,7	7.75	8	305	236	255	150	8	40 x 6	80 x 45
				12.01	9.29	1.04	5.91	.31	1.57 x .24	3.15 x 1.77
400	216	8.64	8	320	260	277	161	8	40 x 6	80 x 45
				12.60	1.24	1.91	6.34	.31	1.57 x .24	3.15 x 1.77
450	219,1	8.76	8	320	261	280	162,5	8	40 x 6	80 x 45
				12.60	1.28	11.02	6.40	.31	1.57 x .24	3.15 x 1.77
500	267	10.68	10	380	325	328	186,5	8	40 x 8	80 x 45
				14.96	12.80	12.91	7.34	.31	1.57 x .31	3.15 x 1.77
550	273	10.92	10	385	330	334	189,5	8	40 x 8	80 x 45
				15.16	12.99	13.15	7.46	.31	1.57 x .31	3.15 x 1.77
600	318	12.72	12	440	375	382	212	8	40 x 8	80 x 45
				17.32	14.76	15.04	8.35	.31	1.57 x .31	3.15 x 1.77
650	323,9	12.96	12	450	382	390	215	8	40 x 8	80 x 45
				17.72	15.04	15.35	8.46	.31	1.57 x .31	3.15 x 1.77
700	355,6	14.22	14	480	420	421	235	12	60 x 8	100 x 50
				18.90	16.54	16.57	9.25	.47	2.36 x .31	3.94 x 1.97
750	368	14.72	14	490	430	434	242	12	60 x 8	100 x 50
				19.29	16.93	17.09	9.53	.47	2.36 x .31	3.94 x 1.97
800	406,4	16.26	16	550	470	472	261	12	60 x 8	100 x 50
				21.65	18.50	18.58	1.28	.47	2.36 x .31	3.94 x 1.97
850	419	16.76	16	550	482	485	267,5	12	60 x 8	100 x 50
				21.65	18.98	19.09	1.53	.47	2.36 x .31	3.94 x 1.97
900	457	18.28	18	585	520	523	286,5	12	60 x 8	100 x 50
				23.03	2.47	2.59	11.28	.47	2.36 x .31	3.94 x 1.97
950	508	20.32	20	630	570	574	312	12	60 x 8	100 x 50
				24.80	22.44	22.60	12.28	.47	2.36 x .31	3.94 x 1.97
1000	521	20.84	20	640	585	587	319	12	60 x 8	100 x 50
				25.20	23.03	23.11	12.56	.47	2.36 x .31	3.94 x 1.97

Alternative materials and surface finishings are available upon request. Contact STAUFF for further information.

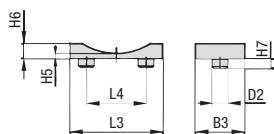

**Flat Steel U-Bolt with Plastic Pipe Saddle (Short) and U-Profile  
(To be used as Fixed Point Clamps only) Type FB+RUK**

**Plastic Pipe Saddle (type RUK)**

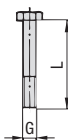
(For size DN 40, dimension L4 is staggered by 90°)

**Hexagon Head Bolt AS**

(according to DIN EN ISO 4014 / 4017)



Diameter Nominal DN	Outside Diameter Pipe / Tube Ø D1		Nominal Bore Pipe (in)	Dimensions (mm/in)							Hexagon Head Bolt (DIN EN ISO 4014 / 4017) Thread G x L
	(mm)	(in)		Plastic Pipe Saddle (type RUK)							
				L3	L4	B3	D2	H5	H6	H7	
40	48,3	1.93	1-1/2	24	25	35	8	5	8	5	M10 x 40
				.94	.98	1.38	.31	.20	.31	.20	
50	57	2.28	2	38	25	50	10	5	10	6	M10 x 40
				1.50	.98	1.97	.39	.20	.39	.24	
65	76,1	3.04	2-1/2	38	25	50	10	5	10	6	M10 x 40
				1.50	.98	1.97	.39	.20	.39	.24	
80	88,9	3.56	3	75	40	70	15	8	17	10	M 12 x 55
				2.95	1.57	2.76	.59	.31	.67	.39	
100	108	4.32	4	75	40	70	15	8	17	10	M 12 x 55
				2.95	1.57	2.76	.59	.31	.67	.39	
125	133	5.32	5	75	40	70	15	8	17	10	M 12 x 55
				2.95	1.57	2.76	.59	.31	.67	.39	
150	159	6.36	6	140	90	75	25	8	26	10	M 16 x 75
				5.51	3.54	2.95	.98	.31	1.02	.39	
175	193,7	7.75	7	140	90	75	25	8	26	10	M 16 x 75
				5.51	3.54	2.95	.98	.31	1.02	.39	
200	216	8.64	8	140	90	75	25	8	26	10	M 16 x 75
				5.51	3.54	2.95	.98	.31	1.02	.39	
250	267	10.68	10	140	90	75	25	8	26	10	M 20 x 80
				5.51	3.54	2.95	.98	.31	1.02	.39	
300	318	12.72	12	220	150	75	30	8	32	10	M 20 x 80
				8.66	5.91	2.95	1.18	.31	1.26	.39	
350	355,6	14.22	14	220	150	75	30	8	32	10	M 24 x 100
				8.66	5.91	2.95	1.18	.31	1.26	.39	
400	406,4	16.26	16	220	150	75	30	8	32	10	M 24 x 100
				8.66	5.91	2.95	1.18	.31	1.26	.39	
500	508	20.32	20	220	150	75	30	8	32	10	M 24 x 100
				8.66	5.91	2.95	1.18	.31	1.26	.39	

**Ordering Codes**
**Flat Steel U-Bolt** \*FB-\*A-48.3-\*W1

 \* Flat Steel U-Bolt **FB**

 \* Exact outside diameter Ø D1 (mm) **A-48.3**

 \* Material code Carbon Steel, uncoated **W1**

 Carbon Steel, zinc-plated, blue-chromated **W32**

 Stainless Steel V4A **W5**

1.4401 / 1.4571 (AISI 316 / 316 Ti)

**only Plastic Pipe Saddle** \*RUK-\*48.3-\*PP

 \* Plastic Pipe Saddle (Short) **RUK**

 \* Exact outside diameter Ø D1 (mm) **48.3**

 \* Material of Pipe Saddle (see below) **PP**

Please note: All items are supplied non-assembled.

**Standard Materials for Plastic Pipe Saddles**

**Polypropylene**

Colour: Green

 Material code: **PP**

**Polyamide**

Colour: Black

 Material code: **PA**

See pages 154 / 155 for material properties and technical information.

Alternative materials are available upon request. Please contact STAUFF for further information.

**Applications**

- Standing or hanging installation of pipes and tubes on beams, profiles and consoles
- Design with two threaded ends allows for ideal adaptation to suit the exact outer diameter of the pipe or tube

Alternative materials and surface finishings are available upon request. Contact STAUFF for further information.



**Round Steel U-Bolt with Plastic Pipe Saddle (Short)**  
**Type RB+RUK**

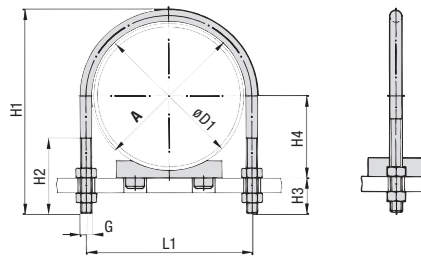

Round Steel U-Bolt (type RB) with Plastic Pipe Saddle (type RUK)

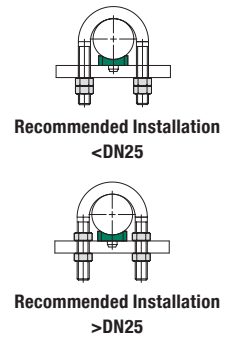

**Ordering Codes**

**Clamp Assembly \*RB+RUK-\*48.3-\*PP-\*W1**

One clamp assembly is consisting of one Round Steel U-Bolt (type RB), one Plastic Pipe Saddle (type RUK) and four Nuts (to DIN EN ISO 4032).

- \* Clamp Assembly (as listed above) **RB+RUK**
- \* Exact outside diameter Ø D1 (mm) **48.3**
- \* Material of Pipe Saddle (see below) **PP**
- \* Material code Carbon Steel, uncoated **W1**  
Carbon Steel, zinc-plated, blue-chromated **W32**  
Stainless Steel V4A 1.4401 / 1.4571 (AISI 316 / 316 Ti) **W5**

Please note: All items are supplied non-assembled.

**Standard Materials for Plastic Pipe Saddles**

- Polypropylene**  
Colour: Green  
Material code: **PP**
- Polyamide**  
Colour: Black  
Material code: **PA**

See pages 154 / 155 for material properties and technical information.

Alternative materials are available upon request. Please contact STAUFF for further information.

**Applications**

- Standing or hanging installation of pipes and tubes on beams, profiles and consoles
- Design with two threaded ends allows for ideal adaptation to suit the exact outer diameter of the pipe or tube

Diameter Nominal	Outside Diameter Pipe / Tube		Nominal Bore Pipe (in)	Dimensions (mm/m)						
	Ø D1 (mm)	(in)		Round Steel U-Bolt (Type RB)						
DN				A	L1	H1	H2	H3	H4	Thread G
20	25	.98		30	40 1.57	73,5 2.89	41 1.61	30 1.18	17,5 .69	M10
	26,9	1.06	3/4	1.18	40 1.57	73,5 2.89	41 1.61	30 1.18	18,5 .73	M10
25	30	1.18		38	48 1.89	81 3.19	48 1.89	30 1.18	20 .79	M10
	33,7	1.33	1	1.50	48 1.89	81 3.19	48 1.89	30 1.18	22 .87	M10
32	38	1.50		46	56 2.20	89 3.50	48 1.89	30 1.18	24 .94	M10
	42,4	1.69	1-1/4	1.81	56 2.20	89 3.50	48 1.89	30 1.18	26,2 1.03	M10
40	44,5	1.76		52	62 2.44	100 3.94	55 2.17	35 1.38	27,2 1.07	M10
	48,3	1.90	1-1/2	2.05	62 2.44	100 3.94	55 2.17	35 1.38	29 1.14	M10
50	57	2.28		64	76 2.99	118 4.65	63 2.48	39 1.54	33,5 1.32	M12
	60,3	2.41	2	2.52	76 2.99	118 4.65	63 2.48	39 1.54	35,2 1.39	M12
65	76,1	3.04	2-1/2	82	94 3.23	135 3.70	77 5.31	39 3.03	43 1.69	M12
	80	3.56	3	94	106 3.70	152 5.98	82 3.23	41 1.61	52,5 2.07	M12
100	108	4.32		120	136 5.35	190 7.48	105 4.13	49 1.93	62 2.44	M16
	114,3	4.57	4	4.72	136 5.35	190 7.48	105 4.13	49 1.93	65 2.56	M16
125	133	5.32		148	164 6.46	217 8.54	105 4.13	49 1.93	74,5 2.93	M16
	139,7	5.59	5	5.83	164 6.46	217 8.54	105 4.13	49 1.93	78 3.07	M16
150	159	6.36		176	192 7.56	247 9.72	105 4.13	51 2.01	87,5 3.44	M16
	168,3	6.73	6	6.93	192 7.56	247 9.72	105 4.13	51 2.01	92 3.62	M16
175	193,7	7.75		202	218 7.96	273 10.75	105 4.13	51 2.01	105 4.13	M16
	200	8.64		228	248 9.76	311 12.24	125 4.92	59 2.32	116 4.57	M20
200	219,1	8.76	8	8.98	248 9.76	311 12.24	125 4.92	59 2.32	117,5 4.63	M20
	250	10.68		282	303 11.93	364 14.33	125 4.92	59 2.32	141,5 5.57	M20
250	273	10.92	10	11.10	302 11.89	364 14.33	125 4.92	59 2.32	144,5 5.69	M20
	300	12.72		332	352 13.86	418 16.46	125 4.92	62 2.44	167 6.57	M20
300	323,9	12.96	12	13.07	352 13.86	418 16.46	125 4.92	62 2.44	170 6.69	M20
	350	14.22	14	378	402 15.83	475 18.70	145 5.71	70 2.76	186 7.32	M24
350	368	14.72		428	402 15.83	475 18.70	145 5.71	70 2.76	192 7.56	M24
	400	16.26	16	428	452 17.80	526 20.71	145 5.71	70 2.76	211 8.31	M24
400	419	16.76		428	452 17.80	526 20.71	145 5.71	70 2.76	217,5 8.56	M24
	500	20.32	20	530	554 21.81	627 24.69	145 5.71	70 2.76	262 10.31	M24
500	521	20.84		530	554 21.81	627 24.69	145 5.71	70 2.76	269 10.59	M24

Alternative materials and surface finishings are available upon request. Contact STAUFF for further information.



## Round Steel U-Bolt with Plastic Pipe Saddle (Short) Type RB+RUK

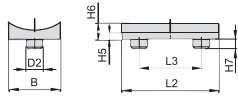

**Plastic Pipe Saddle (type RUK)**  
(For sizes DN 20 to DN 40)

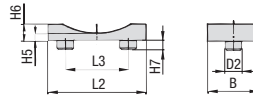

**Plastic Pipe Saddle (type RUK)**  
(From size DN 50 on)



Diameter Nominal DN	Outside Diameter Pipe / Tube Ø D1 (mm) (in)		Nominal Bore Pipe (in)	Dimensions (mm/in) Plastic Pipe Saddle (Type RUK)								
	A	L2		L3	B	H5	H6	H7	D2			
20	25	.98		30	35	25	24	5	8	5	8	
	26,9	1.06	3/4	1.18	1.38	.98	.94	.20	.31	.20	.31	
25	30	1.18		38	35	25	24	5	8	5	8	
	33,7	1.33	1	1.50	1.38	.98	.94	.20	.31	.20	.31	
32	38	1.50		46	35	25	24	5	8	5	8	
	42,4	1.69	1-1/4	1.81	1.38	.98	.94	.20	.31	.20	.31	
40	44,5	1.76		52	35	25	24	5	8	5	8	
	48,3	1.90	1-1/2	2.05	1.38	.98	.94	.20	.31	.20	.31	
50	57	2.28		64	38	25	50	5	10	6	10	
	60,3	2.41	2	2.52	1.50	.98	1.97	.20	.39	.24	.39	
65	76,1	3.04	2-1/2	82	38	25	50	5	10	6	10	
				3.23	1.50	.98	1.97	.20	.39	.24	.39	
80	88,9	3.56	3	94	75	40	70	8	17	10	15	
				3.70	2.95	1.57	2.76	.31	.67	.39	.59	
100	108	4.32		120	75	40	70	8	17	10	15	
	114,3	4.57	4	4.72	2.95	1.57	2.76	.31	.67	.39	.59	
125	133	5.32		148	75	40	70	8	17	10	15	
	139,7	5.59	5	5.83	2.95	1.57	2.76	.31	.67	.39	.59	
150	159	6.36		176	140	90	75	8	26	10	25	
	168,3	6.73	6	6.93	5.51	3.54	2.95	.31	1.02	.39	.98	
175	193,7	7.75		202	140	90	75	8	26	10	25	
				7.96	5.51	3.54	2.95	.31	1.02	.39	.98	
200	216	8.64		228	140	90	75	8	26	10	25	
	219,1	8.76	8	8.98	5.51	3.54	2.95	.31	1.02	.39	.98	
250	267	10.68		282	140	90	75	8	26	10	25	
	273	10.92	10	11.10	5.51	3.54	2.95	.31	1.02	.39	.98	
300	318	12.72		332	220	150	75	8	32	10	30	
	323,9	12.96	12	13.07	8.66	5.91	2.95	.31	1.26	.39	1.18	
350	355,6	14.22	14	378	220	150	75	8	32	10	30	
	368	14.72		14.88	8.66	5.91	2.95	.31	1.26	.39	1.18	
400	406,4	16.26	16	428	220	150	75	8	32	10	30	
	419	16.76		16.85	8.66	5.91	2.95	.31	1.26	.39	1.18	
500	508	2.32	20	530	220	150	75	8	32	10	30	
	521	2.84		2.87	8.66	5.91	2.95	.31	1.26	.39	1.18	

### Ordering Codes

#### Round Steel U-Bolt \*RB-\*A-52-\*W1-\*COMPL

One Round Steel U-Bolt (type RB) includes four Nuts (to DIN EN ISO 4032).

- \* Round Steel U-Bolt **RB**
- \* Dimension A (mm) **A-52**
- \* Material code Carbon Steel, uncoated **W1**  
Carbon Steel, zinc-plated, blue-chromated **W32**  
Stainless Steel V4A 1.4401 / 1.4571 (AISI 316 / 316 Ti) **W5**

#### only Plastic Pipe Saddle \*RUK-\*48.3-\*PP

- \* Plastic Pipe Saddle (Short) **RUK**
- \* Exact outside diameter Ø D1 (mm) **48.3**
- \* Material of Pipe Saddle (see below) **PP**

### Standard Materials for Plastic Pipe Saddles

**Polypropylene**  
Colour: Green  
Material code: **PP**

**Polyamide**  
Colour: Black  
Material code: **PA**

See pages 154 / 155 for material properties and technical information.

Alternative materials are available upon request. Please contact STAUFF for further information.

### Applications

- Standing or hanging installation of pipes and tubes on beams, profiles and consoles
- Design with two threaded ends allows for ideal adaptation to suit the exact outer diameter of the pipe or tube

Alternative materials and surface finishings are available upon request. Contact STAUFF for further information.



## Round Steel U-Bolt with Plastic Pipe Saddle (Long) Type RB+RUL

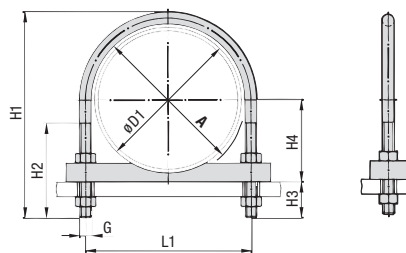

Round Steel U-Bolt (type RB) with Plastic Pipe Saddle (type RUL)

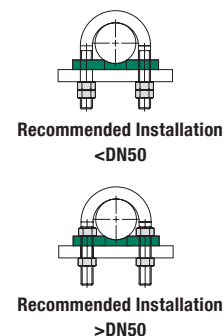

### Ordering Codes

#### Clamp Assembly \*RB+RUL-\*48.3-\*PP-\*W1

One clamp assembly is consisting of one Round Steel U-Bolt (type RB), one Plastic Pipe Saddle (type RUL) and four Nuts (to DIN EN ISO 4032).

- \* Clamp Assembly (as listed above) **RB+RUL**
- \* Exact outside diameter Ø D1 (mm) **48.3**
- \* Material of Pipe Saddle (see below) **PP**
- \* Material code Carbon Steel, uncoated **W1**  
Carbon Steel, zinc-plated, blue-chromated **W32**  
Stainless Steel V4A 1.4401 / 1.4571 (AISI 316 / 316 Ti) **W5**

Please note: All items are supplied non-assembled.

### Standard Materials for Plastic Pipe Saddles

**Polypropylene**  
Colour: Green  
Material code: **PP**

**Polyamide**  
Colour: Black  
Material code: **PA**

See pages 154 / 155 for material properties and technical information.

Alternative materials are available upon request. Please contact STAUFF for further information.

### Applications

- Standing or hanging installation of pipes and tubes on beams, profiles and consoles
- Design with two threaded ends allows for ideal adaptation to suit the exact outer diameter of the pipe or tube

Diameter Nominal DN	Outside Diameter Pipe / Tube Ø D1 (mm) (in)		Nominal Bore Pipe (in)	Dimensions (mm/in)						
	Round Steel U-Bolt (Type RB)			A	L1	H1	H2	H3	H4	Thread G
20	25	.98		30	40	73,5	41	30	17,5	M10
	26,9	1.06	3/4	1.18	1.57	2.89	1.61	1.18	.69	
25	30	1.18		38	48	81	48	30	20	M10
	33,7	1.33	1	1.50	1.89	3.19	1.89	1.18	.79	
32	38	1.50		46	56	89	48	30	24	M10
	42,4	1.69	1-1/4	1.81	2.20	3.50	1.89	1.18	.94	
40	44,5	1.76		52	62	100	55	35	27,2	M10
	48,3	1.90	1-1/2	2.05	2.44	3.94	2.17	1.38	1.07	
50	57	2.28		64	76	118	63	39	33,5	M12
	60,3	2.41	2	2.52	2.99	4.65	2.48	1.54	1.32	
65	76,1	3.04	2-1/2	82	94	135	77	39	43	M12
				3.23	3.70	5.31	3.03	1.54	1.69	
80	88,9	3.56	3	94	106	152	82	39	54,5	M12
				3.70	4.17	5.98	3.23	1.54	2.15	
100	108	4.32		120	136	190	105	47	64	M16
	114,3	4.57	4	4.72	5.35	7.48	4.13	1.85	2.52	
125	133	5.32		148	164	217	105	47	76,5	M16
	139,7	5.59	5	5.83	6.46	8.54	4.13	1.85	3.01	
150	159	6.36		176	192	247	105	47	80	M16
	168,3	6.73	6	6.93	7.56	9.72	4.13	1.85	3.15	
175	193,7	7.75		202	218	273	105	47	91,5	M16
				7.96	8.58	10.75	4.13	1.85	3.60	
200	216	8.64		228	248	311	125	55	96	M16
	219,1	8.76	8	8.98	7.56	9.72	4.13	1.85	3.78	
250	267	10.68		282	303	364	125	55	109	M16
	273	10.92	10	11.10	9.76	12.24	4.92	2.17	120	
300	318	12.72		332	302	364	125	55	121,5	M20
	323,9	12.96	12	13.07	11.89	14.33	4.92	2.17	125	
350	355,6	14.22	14	378	352	418	125	55	145,5	M20
	368	14.72		14.88	13.86	16.46	4.92	2.17	148,5	
400	406,4	16.26	16	428	402	475	145	63	174	M20
	419	16.76		16.85	15.83	18.70	5.71	2.48	177	
500	508	20.32	20	530	452	526	145	63	218	M24
	521	20.84		20.87	17.80	20.71	5.71	2.48	224,5	
					21.81	24.69	5.71	2.48	276	M24
					21.81	24.69	5.71	2.48	10.87	M24

Alternative materials and surface finishings are available upon request. Contact STAUFF for further information.

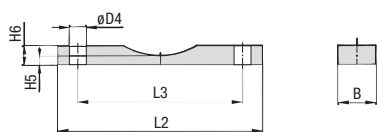

**Round Steel U-Bolt with Plastic Pipe Saddle (Long)  
Type RB+RUL**

**Plastic Pipe Saddle (type RUL)**

Diameter Nominal DN	Outside Diameter Pipe / Tube Ø D1		Nominal Bore Pipe (in)	Dimensions (mm/in)						
	(mm)	(in)		Plastic Pipe Saddle (Type RUL)						
				A	L2	L3	B	H5	H6	Ø D4
20	25	.98		30	75	40	30	5	12	11
	26,9	1.06	3/4	1.18	2.95	1.57	1.18	.20	.47	.43
25	30	1.18		38	80	48	30	5	12	11
	33,7	1.33	1	1.50	3.15	1.89	1.18	.20	.47	.43
32	38	1.50		46	90	56	30	5	12	11
	42,4	1.69	1-1/4	1.81	3.54	2.20	1.18	.20	.47	.43
40	44,5	1.76		52	95	62	35	5	15	11
	48,3	1.90	1-1/2	2.05	3.74	2.44	1.38	.20	.59	.43
50	57	2.28		64	110	76	35	5	15	14
	60,3	2.41	2	2.52	4.33	2.99	1.38	.20	.59	.55
65	76,1	3.04	2-1/2	82	135	94	35	5	15	14
				3.23	5.31	3.70	1.38	.20	.59	.55
80	88,9	3.56	3	94	145	106	40	10	20	14
				3.70	5.71	4.17	1.57	.39	.79	.55
100	108	4.32		120	190	136	40	10	20	18
	114,3	4.57	4	4.72	7.48	5.35	1.57	.39	.79	.71
125	133	5.32		148	190	136	40	10	20	18
	139,7	5.59	5	5.83	7.48	5.35	1.57	.39	.79	.71
150	159	6.36		176	220	164	40	10	20	18
	168,3	6.73	6	6.93	8.66	6.46	1.57	.39	.79	.71
175	193,7	7.75		202	250	192	50	12	25	18
				7.96	9.84	7.56	1.97	.47	.98	.71
200	216	8.64		228	270	218	50	12	25	18
	219,1	8.76	8	8.98	10.63	8.58	1.97	.47	.98	.71
250	267	10.68		282	315	248	50	12	25	22
	273	10.92	10	11.10	12.40	9.76	1.97	.47	.98	.87
300	318	12.72		332	12.40	9.76	1.97	.47	.98	.87
	323,9	12.96	12	13.07	370	302	50	12	25	22
350	355,6	14.22	14	378	14.57	11.89	1.97	.47	.98	.87
	368	14.72		14.88	420	352	60	15	30	22
400	406,4	16.26	16	428	16.54	13.86	2.36	.59	1.18	.87
	419	16.76		16.85	420	352	60	15	30	22
500	508	20.32	20	530	16.54	13.86	2.36	.59	1.18	.87
	521	20.84		20.87	480	402	60	15	30	26
					18.90	15.83	2.36	.59	1.18	1.02
					480	402	60	15	30	26
					18.90	15.83	2.36	.59	1.18	1.02
					540	452	60	15	30	26
					21.26	17.80	2.36	.59	1.18	1.02
					540	452	60	15	30	26
					21.26	17.80	2.36	.59	1.18	1.02
					640	554	60	15	30	26
					25.20	21.81	2.36	.59	1.18	1.02
					640	554	60	15	30	26
					25.20	21.81	2.36	.59	1.18	1.02

**Ordering Codes**
**Round Steel U-Bolt \*RB-\*A-52-\*W1-\*COMPL**

One Round Steel U-Bolt (type RB) includes four Nuts (to DIN EN ISO 4032).

- \* Round Steel U-Bolt **RB**
- \* Dimension A (mm) **A-52**
- \* Material code Carbon Steel, uncoated **W1**  
Carbon Steel, zinc-plated, blue-chromated **W32**  
Stainless Steel V4A 1.4401 / 1.4571 (AISI 316 / 316 Ti) **W5**

**only Plastic Pipe Saddle \*RUL-\*48.3-\*PP**

- \* Plastic Pipe Saddle (Long) **RUL**
- \* Exact outside diameter Ø D1 (mm) **48.3**
- \* Material of Pipe Saddle (see below) **PP**

**Standard Materials for Plastic Pipe Saddles**

**Polypropylene**  
 Colour: Green  
 Material code: **PP**

**Polyamide**  
 Colour: Black  
 Material code: **PA**

See pages 154 / 155 for material properties and technical information.

Alternative materials are available upon request. Please contact STAUFF for further information.

**Applications**

- Standing or hanging installation of pipes and tubes on beams, profiles and consoles
- Design with two threaded ends allows for ideal adaptation to suit the exact outer diameter of the pipe or tube

Alternative materials and surface finishings are available upon request. Contact STAUFF for further information.



**Round Steel U-Bolt (without Plastic Pipe Saddle)  
Type RBD (DIN 3570, Type A)**

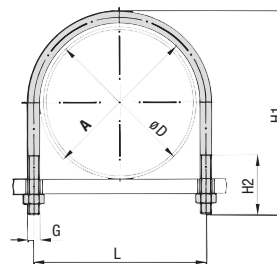

Round Steel U-Bolt (type RBD)

**Ordering Codes**

**Clamp Assembly \*RBD-\*A-30-\*W1-\*COMPL**

One clamp assembly is consisting of one Round Steel U-Bolt (type RBD according to DIN 3570, Type A) and two Nuts (to DIN EN ISO 4032).

- \* Clamp Assembly (as listed above) **RBD**
- \* Dimension A (mm) **A-30**
- \* Material code Carbon Steel, uncoated **W1**  
Carbon Steel, zinc-plated, blue-chromated **W32**  
Stainless Steel V4A 1.4401 / 1.4571 (AISI 316 / 316 Ti) **W5**

Please note: All items are supplied non-assembled.

**Applications**

- Standing or hanging installation of pipes and tubes on beams, profiles and consoles
- Design with two threaded ends allows for ideal adaptation to suit the exact outer diameter of the pipe or tube

Diameter Nominal DN	Outside Diameter Pipe / Tube Ø D1 (mm) (in)		Nominal Bore Pipe (in)	Dimensions (mm/in)				
				Round Steel U-Bolt (Type RBD)				
				A	L	H1	H2	Thread G
20	25	.98		30	40	70	40	M10
	26,9	1.06	3/4	1.18	1.57	2.76	1.57	M10
25	30	1.18		38	48	76	40	M10
	33,7	1.33	1	1.50	1.89	2.99	1.57	M10
32	38	1.50		46	56	86	50	M10
	42,4	1.69	1-1/4	1.81	2.20	3.39	1.97	M10
40	44,5	1.76		52	62	92	50	M10
	48,3	1.90	1-1/2	2.05	2.44	3.62	1.97	M10
50	57	2.28		64	76	109	50	M12
	60,3	2.41	2	2.52	2.99	4.29	1.97	M12
65	76,1	3.04	2-1/2	82	94	125	50	M12
80	88,9	3.56	3	94	106	138	50	M12
100	108	4.32		120	136	171	60	M16
	114,3	4.57	4	4.72	5.35	6.73	2.36	M16
125	133	5.32		148	164	191	60	M16
	139,7	5.59	5	5.83	6.46	7.52	2.36	M16
150	159	6.36		176	192	217	60	M16
	168,3	6.73	6	6.93	7.56	8.54	2.36	M16
175	193,7	7.75		202	218	249	60	M16
200	216	8.64		228	248	283	70	M20
	219,1	8.76	8	8.98	9.76	11.14	2.76	M20
250	267	10.68		282	303	334	70	M20
	273	10.92	10	11.10	11.93	13.15	2.76	M20
300	318	12.72		332	352	385	70	M20
	323,9	12.96	12	13.07	13.86	15.16	2.76	M20
350	355,6	14.22	14	378	402	435	70	M24
	368	14.72		14.88	15.83	17.13	2.76	M24
400	406,4	16.26	16	428	452	487	70	M24
	419	16.76		16.85	17.80	19.17	2.76	M24
500	508	20.32	20	530	554	589	70	M24
	521	20.84		20.87	21.81	23.19	2.76	M24

Alternative materials and surface finishings are available upon request. Contact STAUFF for further information.



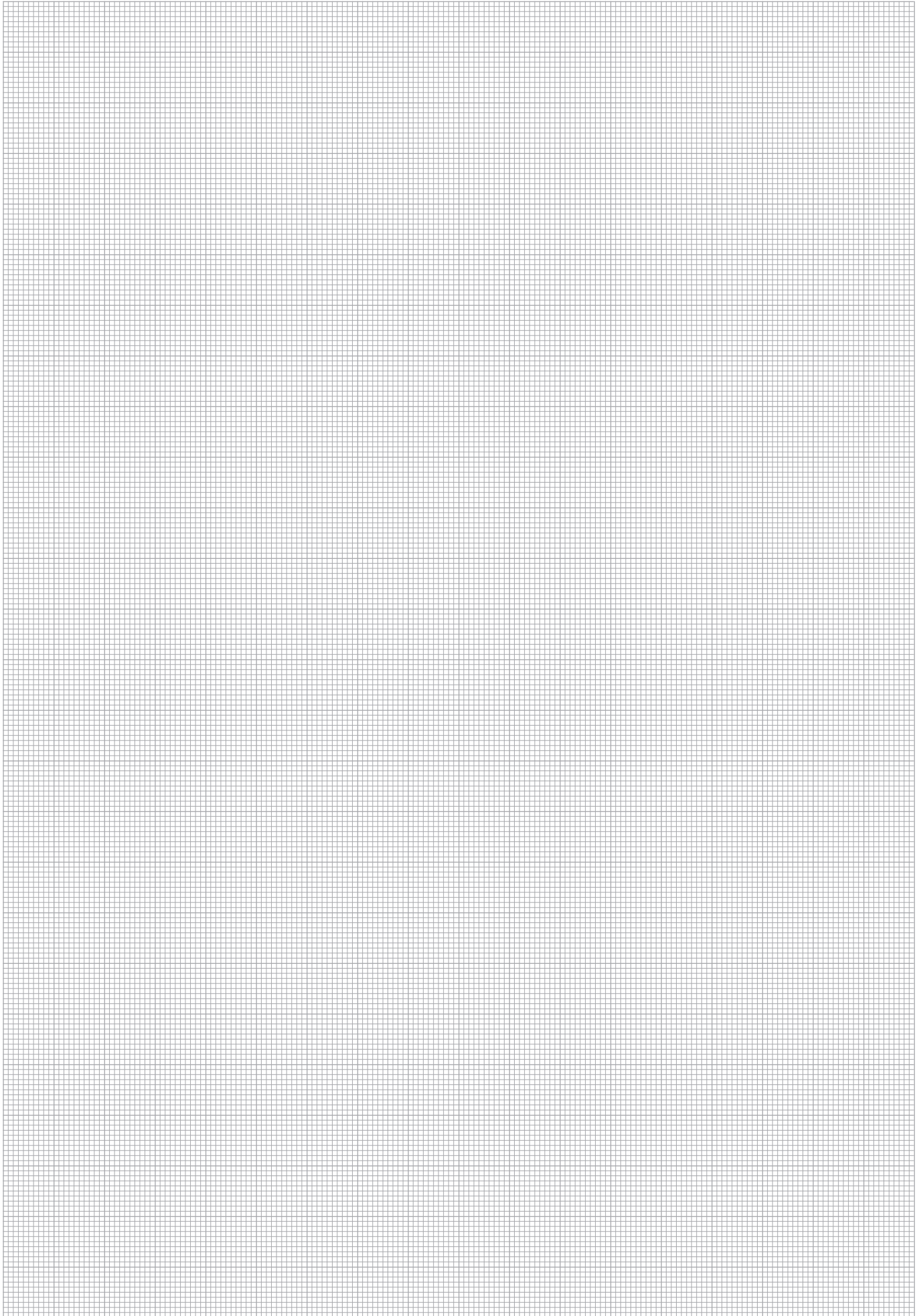

K







**Metal Pipe Clamp with Tension Clearance  
Two-Bolt Design**  
DIN 3567-A

136



**Metal Pipe Clamp with Tension Clearance  
Three-Bolt Design (Extended to One Side)**  
DIN 3567-B

137



**Heavy Saddle with Tension Clearance  
Single-Bolt Design**  
DIN 1592

138



**Heavy Saddle with Tension Clearance  
Two-Bolt Design**  
DIN 1593

139



**Light Saddle with Tension Clearance  
Single-Bolt Design**  
DIN 1596

140



**Light Saddle with Tension Clearance  
Two-Bolt Design**  
DIN 1597

141



## Metal Pipe Clamp with Tension Clearance (DIN 3567-A) Two-Bolt Design

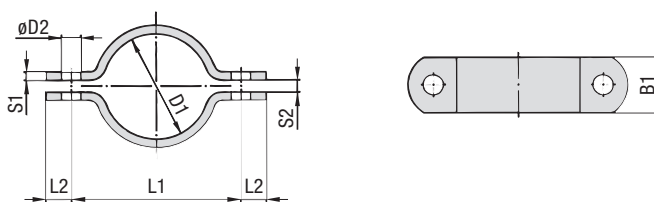

### Ordering Codes

#### Metal Pipe Clamp \*DIN3567-A\*-20\*W1

One metal pipe clamp is consisting of two clamp halves.  
Hexagon head bolts and nuts are not included.

- \* Metal Pipe Clamp to DIN 3567, type A **DIN3567-A**
- \* STAUFF Group (Ø D1) **-20**
- \* Material code Carbon Steel, uncoated **W1**
- Carbon Steel, hot-dip galvanised **W40**
- Stainless Steel V4A **W5**
- 1.4401 / 1.4571 (AISI 316 / 316 Ti)

#### Clamp Assembly \*DIN3567-A\*-20\*W1\*COMPL

One clamp assembly is consisting of two clamp halves,  
two hexagon head bolts and two hexagon head nuts.

- \* Metal Pipe Clamp to DIN 3567, type A **DIN3567-A**
- \* STAUFF Group (Ø D1) **-20**
- \* Material code Carbon Steel, uncoated **W1**
- Carbon Steel, hot-dip galvanised **W40**
- Stainless Steel V4A **W5**
- 1.4401 / 1.4571 (AISI 316 / 316 Ti)

\* Clamp assembly with bolts and nuts **COMPL**

Please note: All items are supplied non-assembled.

### Applications

- Installation of pipes, tubes and other construction elements on beams, profiles and consoles

STAUFF Group	Nominal Size	Dimensions (mm/in)							Accessories
		Pipe (in)	L1	L2	S1	S2	D2	B1	Hexagon Head Bolts (Hexagon Head Nuts)
Ø D1	(mm)								
20	15		57	15	5	7	11.5	30	M10 x 30 (M10) 3/8-16 UNC x 1-1/4 (3/8-16 UNC)
		2.24	.59	.20	.28	.45	1.18		
22			59	15	5	7	11.5	30	
			2.32	.59	.20	.28	.45	1.18	
25	20		62	15	5	7	11.5	30	
			2.44	.59	.20	.28	.45	1.18	
27		3/4	66	15	5	7	11.5	30	
			2.60	.59	.20	.28	.45	1.18	
30	25		68	15	5	7	11.5	30	
				2.68	.59	.20	.28	.45	
34		1	72	15	5	7	11.5	30	
			2.83	.59	.20	.28	.45	1.18	
38	32		76	15	5	7	11.5	30	
				2.99	.59	.20	.28	.45	1.18
43		1-1/4	82	15	5	7	11.5	30	
			3.23	.59	.20	.28	.45	1.18	
45	40		84	15	5	7	11.5	30	
				3.31	.59	.20	.28	.45	1.18
49		1-1/2	88	15	5	7	11.5	30	
			3.46	.59	.20	.28	.45	1.18	
57	50		104	18	6	9	14	40	
				4.09	.71	.24	.35	.55	1.57
61		2	108	18	6	9	14	40	
			4.25	.71	.24	.35	.55	1.57	
77	65	2-1/2	122	18	6	9	14	40	
				4.80	.71	.24	.35	.55	1.57
89	80	3	136	18	6	9	14	40	
				5.35	.71	.24	.35	.55	1.57
108	100		172	24	8	11	18	50	
				6.77	.94	.31	.43	.71	1.97
115		4	178	24	8	11	18	50	
			7.01	.94	.31	.43	.71	1.97	
133	125		196	24	8	11	18	50	
				7.72	.94	.31	.43	.71	1.97
140			204	24	8	11	18	50	
			8.03	.94	.31	.43	.71	1.97	
159	150		222	24	8	11	18	50	
				8.74	.94	.31	.43	.71	1.97
169			232	24	8	11	18	50	
			9.13	.94	.31	.43	.71	1.97	
194	175		258	24	8	11	18	50	
				10.16	.94	.31	.43	.71	1.97
216	200		280	24	8	11	18	50	
				11.02	.94	.31	.43	.71	1.97
220			284	24	8	11	18	50	
			11.18	.94	.31	.43	.71	1.97	
267	250		342	30	8	14	23	60	
				13.46	1.18	.31	.55	.91	2.36
273			348	30	8	14	23	60	
			13.70	1.18	.31	.55	.91	2.36	
318	300		392	30	8	14	23	60	
				15.43	1.18	.31	.55	.91	2.36
324			398	30	8	14	23	60	
			15.67	1.18	.31	.55	.91	2.36	
368	350		444	30	8	14	23	60	
				17.48	1.18	.31	.55	.91	2.36
407	400		498	36	10	18	27	70	
				19.61	1.42	.39	.71	1.06	2.76
419			510	36	10	18	27	70	
			10.08	1.42	.39	.71	1.06	2.76	
521	500		614	36	10	18	27	70	
				24.17	1.42	.39	.71	1.06	2.76

Alternative materials and surface finishings are available upon request. Contact STAUFF for further information.

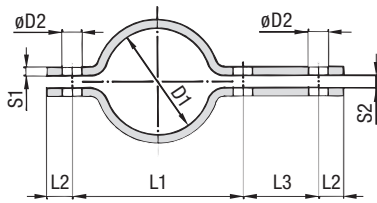

**Metal Pipe Clamp with Tension Clearance (DIN 3567-B)**  
 Three-Bolt Design (Extended to One Side)

STAUFF Group	Nominal Size		Dimensions (mm/in)							Accessories	
	Ø D1	Pipe (in)	L1	L2	L3	S1	S2	D2	B1	Hexagon Head Bolts (Hexagon Head Nuts)	
20	15		57	15	46	5	7	11.5	30	M10 x 30 (M10) 3/8-16 UNC x 1-1/4 (3/8-16 UNC)	
22			2.24	.59	1.81	.20	.28	.45	1.18		
25	20	3/4	59	15	46	5	7	11.5	30		
			2.32	.59	1.81	.20	.28	.45	1.18		
27	20	3/4	62	15	46	5	7	11.5	30		
			2.44	.59	1.81	.20	.28	.45	1.18		
30	25	1	66	15	46	5	7	11.5	30		
			2.60	.59	1.81	.20	.28	.45	1.18		
34	25	1	68	15	46	5	7	11.5	30		
			2.68	.59	1.81	.20	.28	.45	1.18		
38	32	1-1/4	72	15	46	5	7	11.5	30		
			2.83	.59	1.81	.20	.28	.45	1.18		
43	32	1-1/4	76	15	46	5	7	11.5	30		
			2.99	.59	1.81	.20	.28	.45	1.18		
45	40	1-1/2	82	15	46	5	7	11.5	30		
			3.23	.59	1.81	.20	.28	.45	1.18		
49	40	1-1/2	84	15	46	5	7	11.5	30		
			3.31	.59	1.81	.20	.28	.45	1.18		
57	50	2	88	15	46	5	7	11.5	30		
			3.46	.59	1.81	.20	.28	.45	1.18		
61	50	2	104	18	54	6	9	14	40	M12 x 35 (M12) 7/16-14 UNC x 1-3/8 (7/16-14 UNC)	
			4.09	.71	2.13	.24	.35	.55	1.57		
77	65	2-1/2	108	18	54	6	9	14	40		
			4.25	.71	2.13	.24	.35	.55	1.57		
89	80	3	122	18	54	6	9	14	40		
			4.80	.71	2.13	.24	.35	.55	1.57		
108	100	4	136	18	54	6	9	14	40		
			5.35	.71	2.13	.24	.35	.55	1.57		
115	100	4	172	24	70	8	11	18	50		
			6.77	.94	2.76	.31	.43	.71	1.97		
133	125		178	24	70	8	11	18	50		
			7.01	.94	2.76	.31	.43	.71	1.97		
140	125		196	24	70	8	11	18	50		
			7.72	.94	2.76	.31	.43	.71	1.97		
159	150		204	24	70	8	11	18	50		
			8.03	.94	2.76	.31	.43	.71	1.97		
169	150		222	24	70	8	11	18	50		
			8.74	.94	2.76	.31	.43	.71	1.97		
194	175		232	24	70	8	11	18	50		
			9.13	.94	2.76	.31	.43	.71	1.97		
216	200		258	24	70	8	11	18	50		
			10.16	.94	2.76	.31	.43	.71	1.97		
220	200		280	24	70	8	11	18	50		
			11.02	.94	2.76	.31	.43	.71	1.97		
267	250		284	24	70	8	11	18	50		
			11.18	.94	2.76	.31	.43	.71	1.97		
273	250		342	30	86	8	14	23	60		
			13.46	1.18	3.39	.31	.55	.91	2.36		
318	300		348	30	86	8	14	23	60		
			13.70	1.18	3.39	.31	.55	.91	2.36		
324	300		392	30	86	8	14	23	60		
			15.43	1.18	3.39	.31	.55	.91	2.36		
368	350		398	30	86	8	14	23	60		
			15.67	1.18	3.39	.31	.55	.91	2.36		
407	400		444	30	86	8	14	23	60		
			17.48	1.18	3.39	.31	.55	.91	2.36		
419	400		498	36	104	10	18	27	70		
			19.61	1.42	4.09	.39	.71	1.06	2.76		
521	500		510	36	104	10	18	27	70		
			10.08	1.42	4.09	.39	.71	1.06	2.76		
			614	36	104	10	18	27	70		
			24.17	1.42	4.09	.39	.71	1.06	2.76		

**Ordering Codes**
**Metal Pipe Clamp \*DIN3567-B\*-20\*W1**

One metal pipe clamp is consisting of two clamp halves. Hexagon head bolts and nuts are not included.

- \* Metal Pipe Clamp to DIN 3567, type B **DIN3567-B**
- \* STAUFF Group (Ø D1) **-20**
- \* Material code Carbon Steel, uncoated **W1**
- Carbon Steel, hot-dip galvanised **W40**
- Stainless Steel V4A **W5**  
1.4401 / 1.4571 (AISI 316 / 316 Ti)

**Clamp Assembly \*DIN3567-B\*-20\*W1\*COMPL**

One clamp assembly is consisting of two clamp halves, three hexagon head bolts and three hexagon head nuts.

- \* Metal Pipe Clamp to DIN 3567, type B **DIN3567-B**
- \* STAUFF Group (Ø D1) **-20**
- \* Material code Carbon Steel, uncoated **W1**
- Carbon Steel, hot-dip galvanised **W40**
- Stainless Steel V4A **W5**  
1.4401 / 1.4571 (AISI 316 / 316 Ti)
- \* Clamp assembly with bolts and nuts **COMPL**

Please note: All items are supplied non-assembled.

**Applications**

- Installation of pipes, tubes and other construction elements on beams, profiles and consoles

Alternative materials and surface finishings are available upon request. Contact STAUFF for further information.



## Heavy Saddle with Tension Clearance (DIN 1592) Single-Bolt Design

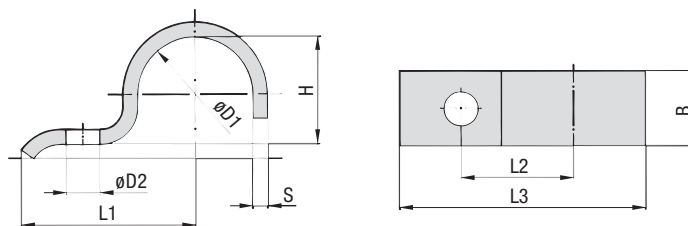

### Ordering Codes

#### Heavy Saddle

**\*DIN1592-\*7-\*W66**

\* Heavy Saddle to DIN 1592

**DIN1592**

\* STAUFF Group (Ø D1)

**7**

\* Material code Carbon Steel, uncoated

**W1**

Carbon Steel, zinc-plated  
and thick-film passivated

**W66**

Stainless Steel V4A  
1.4401 / 1.4571 (AISI 316 / 316 Ti)

**W5**

### Applications

- Installation of pipes, tubes, poles and other round components directly on the substrate (floor, wall or ceiling)

STAUFF Group	Diameter Range		Dimensions (mm/in)						
	Ø D1 (mm)	(in)	L1	L2	L3	H	D2	B	S
7	5,5 ... 7	.22 ... .28	22	14	27,5	5	6,6	16	2
			.87	.55	1.08	.20	.26	.63	.08
9	7 ... 9	.28 ... .35	27	18	33,5	6	6,6	20	2
			1.06	.71	1.32	.24	.26	.79	.08
13	9,5 ... 13	.39 ... .51	40	25	49,5	9	11	25	3
			1.57	.98	1.95	.35	.43	.98	.12
15,5	13 ... 15,5	.51 ... .61	41	26	52	12	11	25	3
			1.61	1.02	2.05	.47	.43	.98	.12
19	15,5 ... 19	.61 ... .75	43	28	55,5	15	11	25	3
			1.69	1.10	2.19	.59	.43	.98	.12
23	20 ... 23	.79 ... .91	51	35	67	19	14	30	5
			2.01	1.38	2.64	.75	.55	1.18	.20
26	23 ... 26	.91 ... 1.02	52	36	70	22	14	30	5
			2.05	1.42	2.76	.87	.55	1.18	.20
28,5	26 ... 28,5	1.02 ... 1.12	53	37	73	24	14	30	5
			2.09	1.46	2.87	.94	.55	1.18	.20
31	28,5 ... 31	1.12 ... 1.22	55	39	75,5	27	14	30	5
			2.17	1.54	2.97	1.06	.55	1.18	.20
36	33 ... 36	1.30 ... 1.42	57	41	81	32	14	40	5
			2.24	1.61	3.19	1.26	.55	1.57	.20
39	36 ... 39	1.42 ... 1.54	59	43	83,5	34	14	40	5
			2.32	1.69	3.29	1.34	.55	1.57	.20
43	39 ... 43	1.54 ... 1.69	68	48	94,5	38	18	40	5
			2.68	1.89	3.72	1.50	.71	1.57	.20
46	43 ... 46	1.69 ... 1.81	70	50	98	41	18	40	5
			2.76	1.97	3.86	1.61	.71	1.57	.20
49	46 ... 49	1.81 ... 1.93	73	53	105,5	44	18	40	8
			2.87	2.09	4.15	1.73	.71	1.57	.31
52 *	49 ... 52	1.93 ... 2.05	76	56	110	47	18	40	8
			2.99	2.20	4.33	1.85	.71	1.57	.31
58	53 ... 58	2.09 ... 2.28	78	58	115	52	18	40	8
			3.07	2.28	4.53	2.05	.71	1.57	.31
61	58 ... 61	2.28 ... 2.40	80	60	118,5	57	18	40	8
			3.15	2.36	4.67	2.24	.71	1.57	.31

\* Similar to DIN 1592.

Alternative materials and surface finishings are available upon request. Contact STAUFF for further information.



## Heavy Saddle with Tension Clearance (DIN 1593) Two-Bolt Design

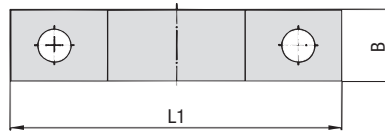
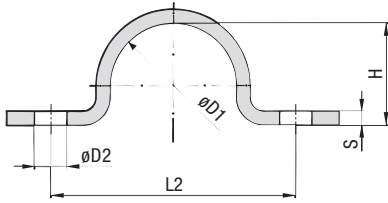

STAUFF Group	Diameter Range		Dimensions (mm/in)					
	Ø D1	(mm)	(in)	L1	L2	H	D2	B
7	5,5 ... 7	.22 ... .28	44	28	5	6,6	16	2
			1.73	1.10	.20	.26	.63	.08
9	7 ... 9	.28 ... .35	48	32	6	6,6	20	2
			1.89	1.26	.24	.26	.79	.08
13	9,5 ... 13	.39 ... .51	52	36	9	6,6	20	2
			2.05	1.42	.35	.26	.79	.08
15,5	13 ... 15,5	.51 ... .61	56	40	12	6,6	20	2
			2.20	1.57	.47	.26	.79	.08
19	15,5 ... 19	.61 ... .75	60	44	15	6,6	20	2
			2.36	1.73	.59	.26	.79	.08
23	20 ... 23	.79 ... .91	82	56	19	11	25	3
			3.23	2.20	.75	.43	.98	.12
26	23 ... 26	.91 ... 1.02	84	58	22	11	25	3
			3.31	2.28	.87	.43	.98	.12
28,5	26 ... 28,5	1.02 ... 1.12	90	64	24	11	25	3
			3.54	2.52	.94	.43	.98	.12
31	28,5 ... 31	1.12 ... 1.22	90	64	27	11	25	3
			3.54	2.52	1.06	.43	.98	.12
36	33 ... 36	1.30 ... 1.42	106	80	32	11	30	5
			4.17	3.15	1.26	.43	1.18	.20
39	36 ... 39	1.42 ... 1.54	110	84	34	11	30	5
			4.33	3.31	1.34	.43	1.18	.20
43	39 ... 43	1.54 ... 1.69	120	88	38	14	30	5
			4.72	3.46	1.50	.55	1.18	.20
46	43 ... 46	1.69 ... 1.81	122	90	41	14	30	5
			4.80	3.54	1.61	.55	1.18	.20
49	46 ... 49	1.81 ... 1.93	122	90	44	14	30	5
			4.80	3.54	1.73	.55	1.18	.20
58	53 ... 58	2.09 ... 2.28	142	110	52	14	40	5
			5.59	4.33	2.05	.55	1.57	.20
61	58 ... 61	2.28 ... 2.40	142	110	57	14	40	5
			5.59	4.33	2.24	.55	1.57	.20
71	67 ... 71	2.64 ... 2.80	152	120	66	14	40	5
			5.98	4.72	2.60	.55	1.57	.20
77	73 ... 77	2.87 ... 3.03	176	136	72	18	40	5
			6.93	5.35	2.83	.71	1.57	.20
81	77 ... 81	3.03 ... 3.19	184	144	76	18	40	5
			7.24	5.67	2.99	.71	1.57	.20
91	88 ... 91	3.39 ... 3.58	198	158	85	18	40	8
			7.80	6.22	3.35	.71	1.57	.31
103	99 ... 103	3.90 ... 4.06	214	174	98	18	40	8
			8.43	6.85	3.86	.71	1.57	.31
109	105 ... 109	4.13 ... 4.29	220	180	104	18	40	8
			8.66	7.09	4.09	.71	1.57	.31
115	110 ... 115	4.33 ... 4.53	226	186	109	18	40	8
			8.90	7.32	4.29	.71	1.57	.31

### Ordering Codes

#### Heavy Saddle

**\*DIN1593-7-\*W66**
**\* Heavy Saddle to DIN 1593**
**DIN1593**
**\* STAUFF Group (Ø D1)**
**7**
**\* Material code** Carbon Steel, uncoated

**W1**

 Carbon Steel, zinc-plated  
and thick-film passivated

**W66**

Stainless Steel V4A

1.4401 / 1.4571 (AISI 316 / 316 Ti)

**W5**

### Applications

- Installation of pipes, tubes, poles and other round components directly on the substrate (floor, wall or ceiling)

Alternative materials and surface finishings are available upon request. Contact STAUFF for further information.



## Light Saddle with Tension Clearance (DIN 1596) Single-Bolt Design

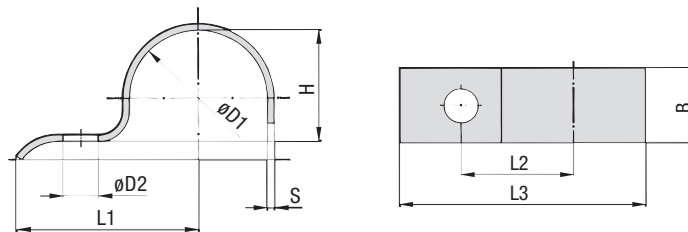

### Ordering Codes

#### Light Saddle

**\*DIN1596-\*7-\*W66**

* Light Saddle to DIN 1596	<b>DIN1596</b>
* STAUFF Group (Ø D1)	<b>7</b>
* Material code	
Carbon Steel, uncoated	<b>W1</b>
Carbon Steel, zinc-plated and thick-film passivated	<b>W66</b>
Stainless Steel V4A	
1.4401 / 1.4571 (AISI 316 / 316 Ti)	<b>W5</b>

### Applications

- Installation of pipes, tubes, poles and other round components directly on the substrate (floor, wall or ceiling)

STAUFF Group	Diameter Range		Dimensions (mm/in)						
	Ø D1 (mm)	(in)	L1	L2	L3	H	D2	B	S
7	5,5 ... 7	.22 ... .28	26	14	31,5	5	6,6	16	2
			1.02	.55	1.24	.20	.26	.63	.08
9	7 ... 9	.28 ... .35	28	16	34,5	6	6,6	16	2
			1.10	.63	1.36	.24	.26	.63	.08
13	9,5 ... 13	.39 ... .51	30	18	38,5	9	6,6	20	2
			1.18	.71	1.52	.35	.26	.79	.08
15,5	13 ... 15,5	.51 ... .61	32	20	41,75	12	6,6	20	2
			1.26	.79	1.64	.47	.26	.79	.08
19	15,5 ... 19	.61 ... .75	34	22	45,5	15	6,6	20	2
			1.34	.87	1.79	.59	.26	.79	.08
23	20 ... 23	.79 ... .91	43	28	57,5	19	9	25	3
			1.69	1.10	2.26	.75	.35	.98	.12
26	23 ... 26	.91 ... 1.02	44	29	60	22	9	25	3
			1.73	1.14	2.36	.87	.35	.98	.12
28,5	26 ... 28,5	1.02 ... 1.12	47	32	64,25	24	9	25	3
			1.85	1.26	2.53	.94	.35	.98	.12
31	28,5 ... 31	1.12 ... 1.22	47	32	65,5	27	9	25	3
			1.85	1.26	2.58	1.06	.35	.98	.12
33 *	31 ... 33	1.22 ... 1.30	56	36	75,5	29	9	25	3
			2.20	1.42	2.97	1.14	.35	.98	.12
36	33 ... 36	1.30 ... 1.42	57	40	78	32	11	30	3
			2.24	1.57	3.07	1.26	.43	1.18	.12
39	36 ... 39	1.42 ... 1.54	59	42	81,5	34	11	30	3
			2.32	1.65	3.21	1.34	.43	1.18	.12
43	39 ... 43	1.54 ... 1.69	61	44	85,5	38	11	30	3
			2.40	1.73	3.37	1.50	.43	1.18	.12
46	43 ... 46	1.69 ... 1.81	62	45	88	41	11	30	3
			2.44	1.77	3.46	1.61	.43	1.18	.12
49	46 ... 49	1.81 ... 1.93	67	48	95,5	44	14	40	4
			2.64	1.89	3.76	1.73	.55	1.57	.16
52 *	49 ... 52	1.93 ... 2.05	72	53	102	47	14	40	4
			2.83	2.09	4.02	1.85	.55	1.57	.16
58	53 ... 58	2.09 ... 2.28	76	55	107	52	14	40	4
			2.99	2.17	4.21	2.05	.55	1.57	.16
61	58 ... 61	2.28 ... 2.40	77	58	111,5	56	14	40	4
			3.03	2.28	4.39	2.20	.55	1.57	.16

\* Similar to DIN 1596.

Alternative materials and surface finishings are available upon request. Contact STAUFF for further information.

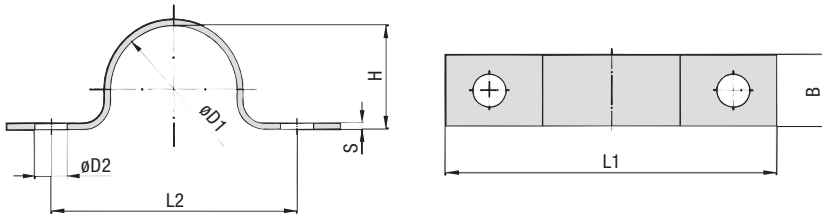

**Light Saddle with Tension Clearance (DIN 1597)**  
 Two-Bolt Design

STAUFF Group	Diameter Range		Dimensions (mm/in)						
	Ø D1	(mm)	(in)	L1	L2	H	D2	B	S
7	5,5 ... 7	.22 ... .28	44	28	5	5,5	16	1,5	
			1.73	1.10	.20	.22	.63	.06	
9	7 ... 9	.28 ... .35	48	32	6	5,5	16	1,5	
			1.89	1.26	.24	.22	.63	.06	
13	9,5 ... 13	.39 ... .51	52	36	9	5,5	16	1,5	
			2.05	1.42	.35	.22	.63	.06	
15,5	13 ... 15,5	.51 ... .61	56	40	12	5,5	16	1,5	
			2.20	1.57	.47	.22	.63	.06	
19	15,5 ... 19	.61 ... .75	60	44	15	5,5	16	1,5	
			2.36	1.73	.59	.22	.63	.06	
23	20 ... 23	.79 ... .91	76	56	19	6,6	20	2	
			2.99	2.20	.75	.26	.79	.08	
26	23 ... 26	.91 ... 1.02	78	58	22	6,6	20	2	
			3.07	2.28	.87	.26	.79	.08	
28,5	26 ... 28,5	1.02 ... 1.12	84	64	24	6,6	20	2	
			3.31	2.52	.94	.26	.79	.08	
31	28,5 ... 31	1.12 ... 1.22	84	64	27	6,6	20	2	
			3.31	2.52	1.06	.26	.79	.08	
33 *	31 ... 33	1.22 ... 1.30	92	72	29	6,6	20	2	
			3.62	2.83	1.14	.26	.79	.08	
36	33 ... 36	1.30 ... 1.42	104	80	32	9	25	3	
			4.09	3.15	1.26	.35	.98	.12	
39	36 ... 39	1.42 ... 1.54	108	84	34	9	25	3	
			4.25	3.31	1.34	.35	.98	.12	
43	39 ... 43	1.54 ... 1.69	112	88	38	9	25	3	
			4.41	3.46	1.50	.35	.98	.12	
46	43 ... 46	1.69 ... 1.81	114	90	41	9	25	3	
			4.49	3.54	1.61	.35	.98	.12	
49	46 ... 49	1.81 ... 1.93	118	90	44	11	30	3	
			4.65	3.54	1.73	.43	1.18	.12	
52 *	49 ... 52	1.93 ... 2.05	134	106	47	11	30	3	
			5.28	4.17	1.85	.43	1.18	.12	
58	53 ... 58	2.09 ... 2.28	138	110	52	11	30	3	
			5.43	4.33	2.05	.43	1.18	.12	
61	58 ... 61	2.28 ... 2.40	138	110	56	11	30	3	
			5.43	4.33	2.20	.43	1.18	.12	

**Ordering Codes**
**Light Saddle**
**\*DIN1597-7-\*W66**

* Light Saddle to DIN 1597	<b>DIN 1597</b>
* STAUFF Group (Ø D1)	<b>7</b>
* Material code	Carbon Steel, uncoated <b>W1</b>
	Carbon Steel, zinc-plated and thick-film passivated <b>W66</b>
	Stainless Steel V4A <b>W5</b>
	1.4401 / 1.4571 (AISI 316 / 316 Ti)

**Applications**

- Installation of pipes, tubes, poles and other round components directly on the substrate (floor, wall or ceiling)

\* Similar to DIN 1597.

Alternative materials and surface finishings are available upon request. Contact STAUFF for further information.







**Construction Series**

KS / DKS

144



**Construction Series**

**(for Anchor Bolt Fastening)**

KSV / DKSV

145



**Construction Series**  
Types KS (Single Version) / DKS (Double Version)

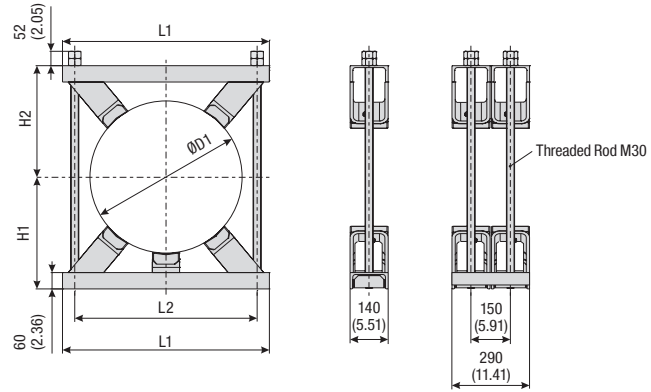
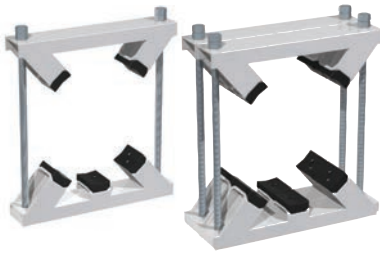

**Ordering Codes**

Construction Series **\*KS-\*220-\*PA-\*W8**

\* Version      Single version      **KS**  
                         Double version      **DKS**

\* Exact outside diameter ØD1 (mm)      **220**

\* Material of Plastic Pads (see below)      **PA**

\* Material Code    Steel, prime coated (grey, RAL 7035)      **W8**

Please note: All items are supplied non-assembled.

**Standard Materials for Plastic Pads**



See pages 154 / 155 for material properties and technical information.

Group	Outside Diameter ØD1 Pipe / Tube Diameter Range		Standard Diameters		Dimensions (mm/in)				No. of Plastic Pads		
	STAUFF	(mm)	(in)	(mm)	(in)	L1	L2	H1		H2	
1	220 ... 275	8.66 ... 10.85	220	8.66	420	16.54	330	12.99	220	8.66	4
			247	9.72							
			267	10.51							
			273	10.75							
			280	11.02							
2	276 ... 325	10.87 ... 12.80	300	11.81	460	18.11	370	14.57	240	9.45	4
			318	12.52							
			323,9	12.75							
			355,6	14.00							
3	326 ... 370	12.83 ... 14.57	368	14.49	510	20.08	420	16.53	260	10.23	4
			390	15.35							
4	371 ... 425	14.61 ... 16.73	406,4	16.00	570	22.44	480	18.89	290	11.42	4
			457,2	18.00							
5	426 ... 485	16.77 ... 19.09	470	18.50	620	24.41	530	20.87	305	12.01	4
			490	19.29							
6	486 ... 550	19.13 ... 21.65	508	20.00	680	26.77	590	23.23	370	14.57	4
			521	20.51							
			546	21.50							
			558,8	22.00							
7	551 ... 630	21.69 ... 24.80	609,6	24.00	760	29.92	670	26.38	410	16.14	5
			711	28.00							
8	631 ... 715	24.84 ... 28.15	845	33.27	755	29.72	452	17.80	452	17.80	5
			940	37.00							
9	716 ... 800	28.19 ... 31.50	850	33.46	940	37.00	850	33.46	495	19.49	5
			813	32.00							
10	813 ... 900	31.50 ... 35.43	900	35.43	990	38.97	900	35.43	500	19.69	5
			1000	39.37							
11	900 ... 1000	35.43 ... 39.37	1000	39.37	1200	47.24	1100	43.30	591,5	23.29	5
			1016	40.00							
12	1016 ... 1100	39.37 ... 43.30	1100	43.30	1200	47.24	1100	43.30	602	23.70	5
			1200	47.24							

Alternative outside diameters, materials and surface finishings are available upon request. Contact STAUFF for further information.





Dimensional drawings: All dimensions in mm (in).

M







	<b>Cushion Clamp Series</b> STC / SPC	148
	<b>Channel Rail</b> SCS	149
	<b>Compact Twin Series</b> DS	150
	<b>Agriculture Twin Series</b> AG	150
	<b>Pipe / Tube Bushing</b> RF	151

**Clamp Assembly - Types STC / SPC**

(for Use with Channel Rail SCS)

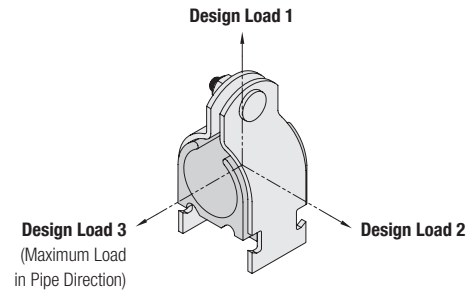
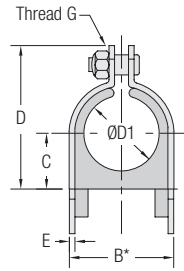

Outside Diameter Pipe / Tube / Hose Ø D1 (mm)	Nominal Bore Pipe (in)	Ordering Codes (1 Clamp Assembly) (*** = Material Code)	Standard Packaging Units pcs.	Dimensions (mm/in)						Design Loads (kN/lbf)		
				B*	C	D	E	Thread G	1	2	3	
6,4	1/4	STC-025-**-K	24 / box	15,7 .62	5,6 .22	28,2 1.11	2 .08	1/4-20 UNC	1,78 400	0,22 50	0,22 50	
8	3/8	STC-037-**-K	24 / box	19,1 .75	7,1 .28	31,5 1.24	2 .08	1/4-20 UNC	1,78 400	0,22 50	0,22 50	
12,7	1/2	STC-050-**-K	24 / box	22,1 .87	8,6 .34	34,5 1.36	2 .08	1/4-20 UNC	1,78 400	0,22 50	0,22 50	
13,5	1/4	SPC-025-**-K	24 / box	23,1 .91	9,1 .36	35,8 1.41	2 .08	1/4-20 UNC	1,78 400	0,22 50	0,22 50	
16	5/8	STC-062-**-K	24 / box	25,4 1.00	10,4 .41	38,1 1.50	2 .08	1/4-20 UNC	1,78 400	0,22 50	0,22 50	
17,2	3/8	SPC-037-**-K	24 / box	27,2 1.07	11,4 .45	40,4 1.59	2 .08	1/4-20 UNC	2,67 600	0,33 75	0,33 75	
19	3/4	STC-075-**-K	24 / box	33,8 1.33	13,5 .53	45,2 1.78	2 .08	1/4-20 UNC	2,67 600	0,33 75	0,33 75	
21,3	1/2	SPC-050-**-K	24 / box	36,8 1.45	15,0 .59	48,5 1.91	2 .08	1/4-20 UNC	2,67 600	0,33 75	0,33 75	
22,2	7/8	STC-087-**-K	24 / box	36,8 1.45	14,7 .58	48,5 1.91	2 .08	1/4-20 UNC	2,67 600	0,33 75	0,33 75	
25,4	1	STC-100-**-K	12 / box	42,2 1.66	16,8 .66	51,6 2.03	2,8 .11	1/4-20 UNC	2,67 600	0,33 75	0,33 75	
26,9	3/4	SPC-075-**-K	12 / box	45,5 1.79	18,3 .72	54,9 2.16	2,8 .11	1/4-20 UNC	2,67 600	0,33 75	0,33 75	
32	1-1/4	STC-125-**-K	12 / box	48,8 1.92	19,8 .78	58,4 2.30	2,8 .11	1/4-20 UNC	2,67 600	0,33 75	0,33 75	
33,7	1	SPC-100-**-K	12 / box	56,4 2.22	23,1 .91	69,9 2.75	3 .12	5/16-18 UNC	2,67 600	0,33 75	0,33 75	
38	1-1/2	STC-150-**-K	12 / box	56,4 2.22	23,1 .91	69,9 2.75	3 .12	5/16-18 UNC	2,67 600	0,33 75	0,33 75	
42	1-1/4	SPC-125-**-K	12 / box	62,7 2.47	26,2 1.03	77,0 3.03	3 .12	5/16-18 UNC	3,56 800	0,56 125	0,56 125	
48,3	1-1/2	SPC-150-**-K	12 / box	62,7 2.47	29,5 1.16	83,3 3.28	3 .12	5/16-18 UNC	3,56 800	0,56 125	0,56 125	
50,8	2	STC-200-**-K	12 / box	69,1 2.72	29,5 1.16	83,3 3.28	3 .12	5/16-18 UNC	3,56 800	0,56 125	0,56 125	
60,3	2	SPC-200-**-K	1 / bag	69,1 3.22	35,8 1.41	96,0 3.78	3 .12	5/16-18 UNC	3,56 800	0,56 125	0,56 125	
63,5	2-1/2	STC-250-**-K	1 / bag	88,1 3.47	38,9 1.53	102,4 4.03	3 .12	5/16-18 UNC	3,56 800	0,56 125	0,56 125	
66,7	2-5/8	STC-262-**-K	1 / bag	88,1 3.47	38,9 1.53	102,4 4.03	3 .12	5/16-18 UNC	3,56 800	0,56 125	0,56 125	
73	2-1/2	SPC-250-**-K	1 / bag	94,5 3.72	42,2 1.66	108,5 4.27	3 .12	5/16-18 UNC	3,56 800	0,56 125	0,56 125	
76,2	3	STC-300-**-K	1 / bag	100,8 3.97	45,2 1.78	114,8 4.52	3 .12	5/16-18 UNC	4,45 1 000	0,89 200	0,67 150	
88,9	3	SPC-300-**-K	1 / bag	110,7 4.36	50,0 1.97	124,7 4.91	3 .12	3/8-16 UNC	4,45 1 000	0,89 200	0,67 150	
102	3-1/2	SPC-350-**-K	1 / bag	126,2 4.97	57,9 2.28	140,5 5.53	3 .12	3/8-16 UNC	4,45 1 000	0,89 200	0,67 150	
114	4	SPC-400-**-K	1 / bag	138,9 5.47	64,3 2.53	153,2 6.03	3 .12	3/8-16 UNC	4,45 1 000	0,89 200	0,67 150	
140	5	SPC-500-**-K	1 / bag	164,3 6.47	77,0 3.03	178,6 7.03	3,6 .14	3/8-16 UNC	4,45 1 000	0,89 200	0,67 150	
168	6	SPC-600-**-K	1 / bag	189,7 7.47	89,7 3.53	204,0 8.03	3,6 .14	3/8-16 UNC	4,45 1 000	0,89 200	0,67 150	

\* Minimum required for installation.

One clamp assembly is consisting of two carbon steel clamp halves (one with threaded stud), one thermoplastic cushion insert and one lock nut with Nylon insert. Channel rail not included. All threaded parts are only available with unified coarse (UNC) thread. Alternative materials and surface finishings are available upon request. Contact STAUFF for further information.



**Clamp Assembly ■ Types STC / SPC**  
(for Use with Channel Rail SCS)

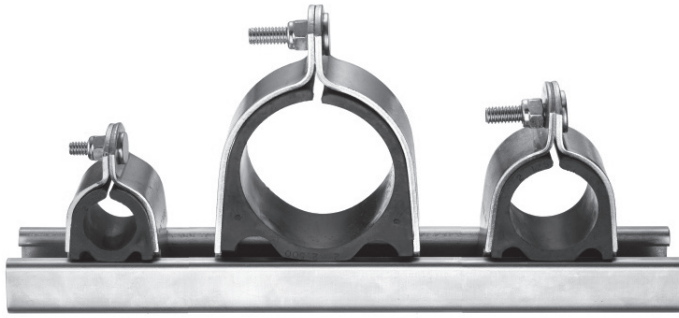

**Standard Materials**



Cushion Insert  
**Thermoplastic Elastomer** (80 Shore-A)  
Colour: Black

The cushion material is compatible with most oils, chemicals and cleaning solvents and suitable for applications within a temperature range of -50 °C ... +125 °C (-58 °F ... +257 °F).

Alternative materials are available upon request.  
Please contact STAUFF for further information.

**Product Features**

- Clamp assemblies designed to mount directly to 41,3 mm / 1-5/8 in wide strut channels, such as the STAUFF Channel Rail, type SCS
- Suitable for most Fluid Power applications ranging from mobile equipment to industrial machinery
- Reduced horizontal mounting space
- Easy installation and retro fit capability
- Reduces shock and vibration while preventing galvanic corrosion

**Ordering Codes**

Clamp Assembly		*STC-*125-*W4-*K
* Type of clamp	STC (Tube diameters) SPC (Pipe diameters)	STC SPC
* Pipe / Tube O.D. (according to dimension table)		125
* Material code	Carbon Steel, zinc-plated, blue-chromated Stainless Steel V2A 1.4301 (AISI 304) Stainless Steel V4A 1.4401 (AISI 316)	W32 W4 W5
Assembling	Components packed in kits	K

**Channel Rail ■ Type SCS**

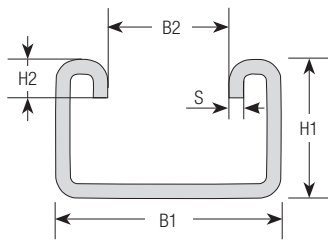

Dimensions (mm/in)				
B1	B2	H1	H2	S
41,3	22,2	25,4	7	2,7
1.63 (1-5/8)	.88 (7/8)	1.00	.28	.11

Alternative rail profiles, materials and surface finishings are available upon request. Contact STAUFF for further information.

**Ordering Codes**

Strut Channel		*SCS-*048-*1-*PL
* Strut Channel		SCS
* Length of Rail	1,22 m / 4.00 ft / 48 in 3,05 m / 10.00 ft / 120 in	048 120
* Height of Rail	25,4 mm / 1.00 in	1
* Material code	Carbon Steel, uncoated Carbon Steel, green painted	PL GR

N



### Compact Twin Series: Clamp Body Type DS

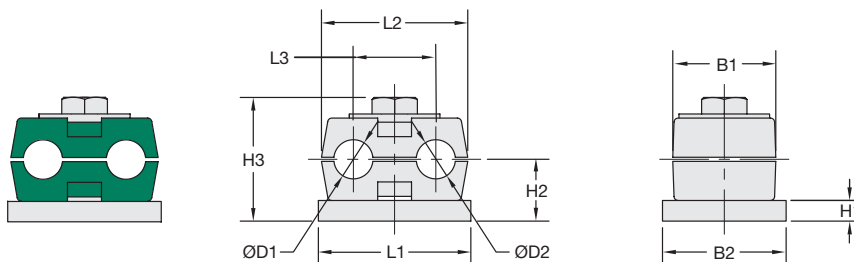

#### Ordering Codes

**Clamp Body** \*1-\*06/06-\*PP-\*DS

One clamp body is consisting of two clamp halves.

- \* STAUFF Group DS 1 **1**
- \* Exact outside diameters Ø D1 / Ø D2 (mm) **06/06**
- \* Clamp Body Material (Polypropylene) **PP**
- \* Compact Twin Series **DS**

Group	Outside Diameter Pipe / Tube Ø D1 / Ø D2		Nominal Bore Pipe (in)	Copper Tube ASTM B88 (in)	Ordering Codes (2 Clamp Halves)	Dimensions (mm/in)								
	(mm)	(in)				L1	L2	L3	H1	H2	H3	B1	B2	
STAUFF DS 1	6				106/06-PP-DS									
	6,4	1/4			106.4/06.4-PP-DS									
	8	5/16			108/08-PP-DS	37	35,5	20	5	15	30	25	30	
	9,5	3/8		1/4	109.5/09.5-PP-DS	1.46	1.40	.79	.20	.59	1.18	.98	1.18	
	10		1/8		110/110-PP-DS									

Additional outside diameters are available upon request. Please contact STAUFF for further information.

### Compact Twin Series: Metal Hardware

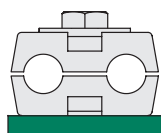

**Weld Plate, Type SP-DS**

**SP-DS-1-U-W2**  
Thread size: 1/4–20 UNC  
Carbon Steel, phosphated

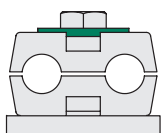

**Cover Plate, Type US-DS**

**US-DS-1-W3**  
Carbon Steel, zinc/nickel-plated

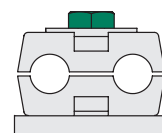

**Hexagon Bolt, Type AS**

**AS-1/4-20UNCx1-W3**  
Thread size: 1/4–20 UNC  
Carbon Steel, zinc/nickel-plated

All threaded parts are only available with unified coarse (UNC) thread. Rail mount and stacking assemblies as well as alternative materials and surface finishings are available upon request.

### Agriculture Twin Series: Clamp Body Type AG

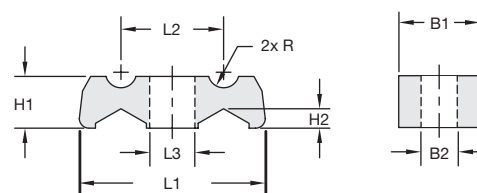
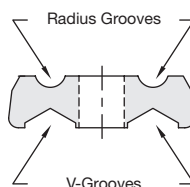

Group	Min/Max Outside Diameters Pipe / Tube				Ordering Codes (1 Clamp Body)	Dimensions (mm/in)							
	Radius Grooves		V-Grooves			L1	L2	L3	H1	H2	B1	B2	R
STAUFF	(mm)	(in)	(mm)	(in)									
2	3 ... 10	.12 ... .39	4 ... 15	.26 ... .59	215.8/09.6-PP-AG-BK	57,5 2.26	31,7 1.25	14,0 .55	16,0 .63	7,1 .24	25,0 .98	11,0 .43	4,8 .19
3	4 ... 25	.16 ... .98	7 ... 20	.28 ... .79	324.8/19.5-PP-AG-BK	62,0 2.48	34,5 1.36	14,0 .55	19,0 .75	7,1 .28	32,0 1.26	11,0 .43	12,4 .49

#### Standard Material



Polypropylene  
Colour: Black

See pages 154 / 155 for properties and technical information.

#### Product Features

- Flip the clamp body to choose between the radius grooved or the v-grooved design (suitable for a range of diameters)
- Use M10 or 3/8–16 UNC bolts or screws (preferably with washers) to fasten clamp bodies directly to the machine
- Clamp bodies can be stacked for multi-level assembly

Additional outside diameters are available upon request. Please contact STAUFF for further information.



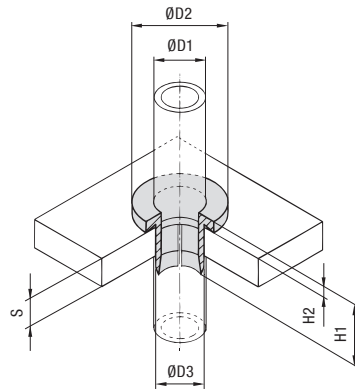

## Pipe / Tube Bushing - Type SRF



Outside Diameter ØD1		Nominal Bore (in)	Dimensions (mm/in)			Wall Thickness (mm/in)		Mounting Bore (mm/in)
(mm)	(in)		ØD2	H1	H2	S	ØD3	
6	1/4		18	22	4	4 ... 12	10	
			.71	.87	.16	.16 ... .47	.39	
8	5/16		20	22	4	4 ... 12	12	
			.79	.87	.16	.16 ... .47	.47	
10	3/8	1/8 Pipe 1/4 Copper Tube (ASTM B88)	22	22	4	4 ... 12	14	
			.87	.87	.16	.16 ... .47	.55	
12	1/2	3/8 Copper Tube (ASTM B88)	24	22	4	4 ... 12	16	
			.94	.87	.16	.16 ... .47	.63	
14		1/4 Pipe	26	22	4	4 ... 12	18	
			1.02	.87	.16	.16 ... .47	.71	
15			28	22	4	4 ... 12	20	
			1.10	.87	.16	.16 ... .47	.79	
16	5/8	1/2 Copper Tube (ASTM B88)	28	22	4	4 ... 12	20	
			1.10	.87	.16	.16 ... .47	.79	
18			30	22	4	4 ... 12	22	
			1.18	.87	.16	.16 ... .47	.87	
20	3/4		32	22	4	4 ... 12	24	
			1.26	.87	.16	.16 ... .47	.94	
22	7/8	3/4 Copper Tube (ASTM B88)	34	22	4	4 ... 12	26	
			1.34	.87	.16	.16 ... .47	1.02	
			38	22	4	4 ... 12	30	
25	1		1.50	.87	.16	.16 ... .47	1.18	
			41	22	4	4 ... 12	33	
28		1 Copper Tube (ASTM B88)	1.61	.87	.16	.16 ... .47	1.30	
			43	22	4	4 ... 12	34	
30			1.69	.87	.16	.16 ... .47	1.39	
			48	22	4	4 ... 12	40	
35		1-1/4 Copper Tube (ASTM B88)	1.89	.87	.16	.16 ... .47	1.57	
			51	22	4	4 ... 12	43	
38	1-1/2		2.01	.87	.16	.16 ... .47	1.70	
			55	22	4	4 ... 12	47	
42		1-1/4 Pipe 1-1/2 Copper Tube (ASTM B88)	2.17	.87	.16	.16 ... .47	1.85	

## Ordering Codes

## Pipe / Tube Bushing

**\*SRF-\*20-\*PP**

- \* Pipe / Tube Bushing SRF
- \* Exact outside diameter Ø D1 (mm) 20
- \* Material code (see below) PP

## Standard Materials



**Polypropylene**  
Colour: Natural colour  
Material code: **PP**



**Thermoplastic Elastomer (87 Shore-A)**  
Colour: Black  
Material code: **SA**

See pages 154 / 155 for material properties and technical information.

## Product Features

- Designed to centre the pipe or tube in a through-hole (e.g. for return lines entering the hydraulic reservoir)
- Vibration and noise absorbing element
- Available for all commonly used Metric and imperial pipe and tube diameters from 6 ... 42 mm and 1/4 ... 1-1/2 in
- Easy plug-in installation





Standard Clamp Body Materials	154
Standard Elastomer Insert Materials	155
Special Clamp Body Materials	156
Standard Clamp Body Designs	158
Materials and Surface Finishings of Metal Parts	159
Property Classes / Grades of Bolts and Screws	159
Thread Conversion Chart	159
General Installation Instructions	160
Tightening Torques / Maximum Loads in Pipe Direction	161
Dimensions and Weights of Clamp Assemblies	162
Packaging Units (Selection)	163



## Standard Clamp Body Materials



Material Code	PP	PA	AL	SA
Basic Material	Copolymeric Polypropylene	Polyamide	Aluminium AISi12	Thermoplastic Elastomer
Standard Colour	Green	Black	Natural	Black

Mechanical Properties				
Tensile E-Module	1073 N/mm <sup>2</sup> (ISO 527)	> 1400 N/mm <sup>2</sup> (ISO 527)	> 65000 N/mm <sup>2</sup>	113 N/mm <sup>2</sup> at +23 °C / +73.4 °F (ASTM D412)
Notch Impact Strength	8 kJ/m <sup>2</sup> at +23 °C / +73.4 °F (acc. to Charpy / ISO 179 / 1eU)	> 15 kJ/m <sup>2</sup> at 23 °C / +73.4 °F (acc. to Charpy / ISO 179 / 1eU)		
Low Temperature Notch Impact Strength	3 kJ/m <sup>2</sup> at -20 °C / -4.0 °F (acc. to Charpy / ISO 179 / 1eU)	> 3 kJ/m <sup>2</sup> at -30 °C / -22.0 °F (acc. to Charpy / ISO 179 / 1eU)		
Tensile Strength at Yield (Tensile Strength)	26 MPa (ISO 527-2)	> 55 MPa (ISO 527)	> 240 MPa (ISO EN 10002)	15,9 MPa (ASTM D412)
Ball Indentation Hardness (Brinell Hardness)	45,4 MPa (ISO 2039-1)	> 65 MPa (ISO 2039-1)	> 70 HBS	
Shore Hardness				87 A (ISO 868) <small>Alternative hardnesses are available upon request! Contact STAUFF for details.</small>

Thermal Properties				
Temperature Resistance (Min ... Max)	-30 °C ... +90 °C / -22 °F ... +194 °F	-40 °C ... +120 °C / -40 °F ... +248 °F <small>(Brief exposure up to +140 °C / +284 °F)</small>	up to +300 °C / up to +572 °F	-40 °C ... +125 °C / -40 °F ... +257 °F

Chemical Properties				
Weak Acids	conditionally consistent	conditionally consistent	conditionally consistent	consistent
Solvents	conditionally consistent	conditionally consistent	conditionally consistent	conditionally consistent
Benzine	conditionally consistent	consistent	consistent	conditionally consistent
Mineral Oils	conditionally consistent	consistent	consistent	conditionally consistent
Other Oils	consistent	consistent	consistent	consistent
Alcohols	consistent	consistent	consistent	consistent
Seawater	consistent	consistent	consistent	consistent



### Special Clamp Body Materials

Please contact STAUFF for further details on fire-proof clamp body materials, tested and approved according to several international fire-protection standards (such as BS 6853, EN 45545-2, UL 94 and many more).

See pages 156 / 157 for material properties and technical information.

The information for the Polyamide material PA have been determined in a conditioned state according to ISO 1110.

For Aluminium, the tensile strength (under reversed bending stress) and impact bending strength both rise constantly at decreasing temperatures whilst the value for breaking elongation decreases.

STAUFF preserves the right to supply products made from alternative, but comparable materials with matching technical characteristics.



## Standard Clamp Insert Materials

 STAUFF Group 4 and 6 (Standard Series)  
 STAUFF Group 4S to 6S (Heavy Series)

STAUFF Group 7S to 10S (Heavy Series)

SA	EPDM	Material Code
Thermoplastic Elastomer	Ethylene Propylene Diene Monomer	Basic Material
Black	Black	Standard Colour

		Mechanical Properties
16 N/mm <sup>2</sup> at +23 °C / +73.4 °F (ASTM D412)		Tensile E-Module
		Notch Impact Strength
		Low Temperature Notch Impact Strength
8,3 MPa (ASTM D412)	9,0 MPa (DIN 53504)	Tensile Strength at Yield (Tensile Strength)
		Ball Indentation Hardness (Brinell Hardness)
73 A (ISO 868)	70 A (DIN 53505)	Shore Hardness

		Thermal Properties
-40 °C ... +125 °C / -40 °F ... +257 °F	-50 °C ... +120 °C / -58 °F ... +248 °F	Temperature Resistance (Min ... Max)

		Chemical Properties
consistent	consistent	Weak Acids
conditionally consistent	consistent	Solvents
conditionally consistent	conditionally consistent	Benzine
conditionally consistent	conditionally consistent	Mineral Oils
consistent	conditionally consistent	Other Oils
consistent	consistent	Alcohols
consistent	consistent	Seawater



## Special Clamp Insert Materials

Please contact STAUFF for further details on fire-proof clamp body materials, tested and approved according to several international fire-protection standards (such as BS 6853, EN 45545-2, UL 94 and many more).

See pages 156 / 157 for material properties and technical information.



## Special Clamp Body Materials (Selection)

### Preventive Fire Protection



Material Code	PA-V0	PP-DA
Basic Material	Polyamide	Polypropylene
Standard Colour	Grey	White

#### Mechanical Properties

Tensile E-Module	1500 MPa (ISO 527-2)	1614 N/mm <sup>2</sup> (ISO 527) at +23 °C / +73.4 °F: 50 mm/min
Notch Impact Strength	35 kJ/m <sup>2</sup> at +23 °C / +73.4 °F (acc. to Charpy / ISO 179 / 1eU)	13 kJ/m <sup>2</sup> at +23 °C / +73.4 °F (acc. to IZOD / ISO 179 / 1eA)
Low Temperature Notch Impact Strength		1,5 kJ/m <sup>2</sup> at -25 °C / -13.0 °F (acc. to IZOD / ISO 179 / 1eA)
Tensile Strength at Yield (Tensile Strength)	45 MPa (ISO 527-2)	12,4 MPa (ISO 527) at +23 °C / +73.4 °F: 50 mm/min
Ball Indentation Hardness (Brinell Hardness)	100 N/mm <sup>2</sup> (ISO 2039-1)	
Shore Hardness		

#### Thermal Properties

Temperature Resistance (Min ... Max)	-30 °C ... +120 °C / -22 °F ... +248 °F	-25 °C ... +90 °C / -13 °F ... +194 °F
--------------------------------------	---	--

#### Features

Approvals / Properties	<p><b>Tested and approved acc. to UL94 <sup>1</sup></b> (material thickness: 3 mm)</p> <ul style="list-style-type: none"> <li>Classification: V-0 (Vertical Burning Test)</li> </ul> <p><b>Tested and approved acc. to EN 45545-2</b> (material thickness: 3,5 mm)</p> <ul style="list-style-type: none"> <li>Requirements set R22</li> <li>Hazard level HL3</li> </ul> <p><b>Tested and approved acc. to DIN 5510, Part 2</b> (material thickness: 3 mm)</p> <ul style="list-style-type: none"> <li>Combustibility classification: S4</li> <li>Smoke development classification: SR2</li> <li>Dripping classification: ST2</li> </ul> <p><b>Tested and approved acc. to NF F 16-101</b> (material thickness: 3 mm)</p> <ul style="list-style-type: none"> <li>Classification: I3 / F2</li> </ul>	<p><b>Tested and approved acc. to UL94 <sup>1</sup></b> (material thickness: 3 mm)</p> <ul style="list-style-type: none"> <li>Classification: V-0 (Vertical Burning Test)</li> </ul> <p><b>Tested and approved acc. to Def Stan 07-247</b></p> <ul style="list-style-type: none"> <li>Assessment: category B</li> </ul> <p><b>Approved by the UK Ministry of Defence (MoD)</b></p>
------------------------	---	--

<sup>1</sup> Successful testing and approval according to UL94 (classification V-0) is equivalent to EN 45545-2 (requirements set R26; hazard level HL3). The information for PA-V0 has been determined in a conditioned state according to ISO 1110.

STAUFF preserves the right to supply products made from alternative, but comparable materials with matching technical characteristics.



## Special Clamp Body Materials (Selection)

## Preventive Fire Protection



PP6853	PP-V0	SA-V0	Material Code
Polypropylene	Polypropylene	Thermoplastic Elastomer	Basic Material
White	Black	Natural	Standard Colour

			Mechanical Properties
1264 MPa (ICE 60811-1-1)		113 N/mm <sup>2</sup> at +23 °C / +73.4 °F (ASTM D412)	Tensile E-Module
17 kJ/m <sup>2</sup> at +23 °C / +73.4 °F (acc. to IZOD / ISO 179 / 1eA)	5 kJ/m <sup>2</sup> at +23 °C / +73.4 °F (acc. to ISO 180/A)		Notch Impact Strength
			Low Temperature Notch Impact Strength
25 MPa (ICE 60811-1-1)	24 MPa (ISO 527)	15,9 MPa (ASTM D412)	Tensile Strength at Yield (Tensile Strength)
			Ball Indentation Hardness (Brinell Hardness)
		86 A (ISO 868)	Shore Hardness

			Thermal Properties
-25 °C ... +90 °C / -13 °F ... +194 °F	-25 °C ... +90 °C / -13 °F ... +194 °F	-50 °C ... +90 °C / -58 °F ... +194 °F	Temperature Resistance (Min ... Max)

			Features
<p><b>Tested and approved acc. to EN 45545-2</b> (material thickness: 3 mm)</p> <ul style="list-style-type: none"> <li>Requirements set R22</li> <li>Hazard level HL3</li> </ul> <p><b>Tested and approved acc. to BS 6853</b> (Code of practice for fire precautions in the design /construction of passenger carrying trains)</p> <ul style="list-style-type: none"> <li>Assessment: category 1a</li> </ul> <p><b>Compliant to the requirements of London Underground / Metronet</b> (standard 2-01001-002: Fire Safety Performance of Materials)</p> <p><b>Tested and approved acc. to DIN 5510, Part 2</b> (material thickness: 25 mm)</p> <ul style="list-style-type: none"> <li>Combustibility classification: S4</li> <li>Smoke development classification: SR2</li> <li>Dripping classification: ST2</li> </ul> <p><b>Tested and approved acc. to Def Stan 07-247</b></p> <ul style="list-style-type: none"> <li>Assessment: category B</li> </ul> <p><b>Compliant to the requirements of JRMA</b> (Japan Railway Rollingstock &amp; Machinery Association)</p> <ul style="list-style-type: none"> <li>Classification: extremely incombustible</li> </ul> <p><b>Compliant to the requirements of NFPA 130</b> (Standard for Fixed Guideway Transit and Passenger Rail Systems)</p>	<p><b>Tested and approved acc. to UL94 <sup>1</sup></b> (material thickness: 3 mm)</p> <ul style="list-style-type: none"> <li>Classification: V-0 (Vertical Burning Test)</li> </ul>	<p><b>Tested and approved acc. to UL94 <sup>1</sup></b> (material thickness: 3 mm)</p> <ul style="list-style-type: none"> <li>Classification: V-0 (Vertical Burning Test)</li> </ul>	Approvals / Properties

<sup>1</sup> Successful testing and approval according to UL94 (classification V-0) is equivalent to EN 45545-2 (requirements set R26; hazard level HL3).



## Standard Clamp Body Designs

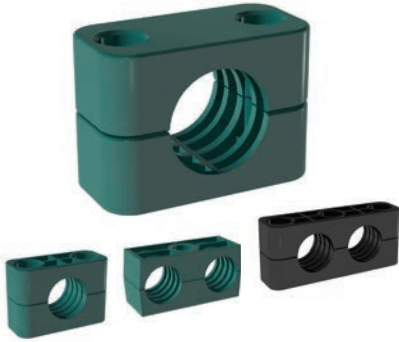

### Profiled Design

#### Profiled Inside Surface with Tension Clearance

- Available in the Standard, Heavy, Twin and Heavy Twin Series
- Recommended for the safe installation of rigid pipes or tubes
- Available for all commonly used outside diameters and nominal sizes
- Vibration/noise reducing and impact absorbing effect towards the direction of the line provided by the grooves on the inside of the clamp bodies
- Clearance  $S$  between the clamp halves provides tension of the tube or pipe
- To be used as fixed point clamp preventing the line from sliding (see page 161 for Maximum Loads in Pipe Direction)

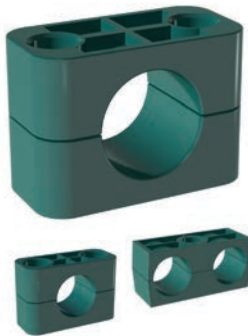
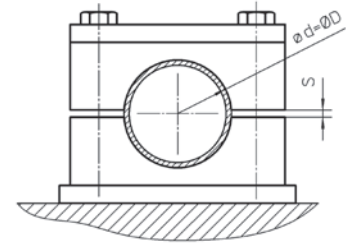

### Type H (Smooth)

#### Smooth Inside Surface w/o Tension Clearance

- Available in the Standard, Heavy and Twin Series
- Recommended for the safe installation of hoses or cables
- Available for all commonly used outside diameters and nominal sizes
- Smooth inside surface and chamfered edges avoid damaging of the hose or cable

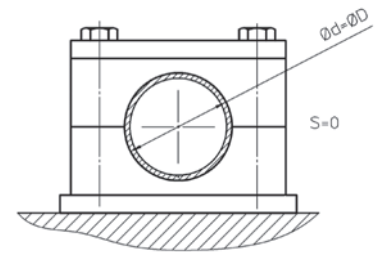

- Choose the diameter  $\phi D$  of the clamp body slightly larger (in accordance to your specific requirements) than the outside diameter  $\phi d$  of the pipe, tube, hose or cable in order to use it as a longitudinal guide allowing the line to slide

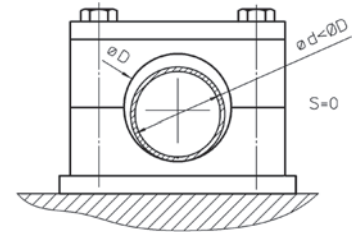

### Type RI (with Elastomer Insert)

- Available in the Standard, Heavy and Heavy Twin Series
- Recommended for the extra-gentle installation of pipes, tubes, hoses or cables
- Available for all commonly used outside diameters and nominal sizes
- Elastomer insert made of Thermoplastic Elastomer with a hardness of 73 Shore-A provides most effective reduction of vibration and noise caused by vibration

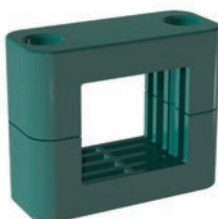

### Rectangular Design - Type VK

- Available in the Standard Series (STAUFF Group 5)
- Recommended for the safe installation of proximity switches according to DIN EN 60947-5-2 or similar, rectangular construction, with a square of 40 mm x 40 mm (1.57 in x 1.57 in) or 40 mm x 36 mm (1.57 in x 1.42 in)



## Materials and Surface Finishings of Metal Parts

## Materials

Unless otherwise stated, all metal parts (e.g. weld plates, cover plates, bolts, rail nuts etc.) are made of **Carbon Steel** (surface finishing according to material code).

Besides that, all metal parts are also available **ex stock** in two different stainless steel qualities:

**Stainless Steel V2A**

- 1.4301 / 1.4305 (AISI 304 / 303)
- Material code: W4

**Stainless Steel V4A**

- 1.4401 / 1.4571 (AISI 316 / 316 Ti)
- Material code: W5

Alternative materials (e.g. Aluminium) are available upon request. Contact STAUFF for further information.

## Surface Finishings

Unless otherwise stated, all metal parts made of Carbon Steel are available with the following standard surface finishings:

**Carbon Steel, uncoated**

- Material code: W1

**Carbon Steel, phosphated**

- Fe/Znph r 10 according to DIN EN 12476
- Material code: W2

**Carbon Steel, zinc/nickel-plated**

- More than 1200 hours resistance against red rust / base metal corrosion in the salt spray test to DIN EN ISO 9227
- Free of hexavalent chromium Cr(VI)
- RoHS compliant according to 2002/95/EC (Restrictions of the Use of Hazardous Substances)
- ELV compliant according to 2000/53/EC (End of Life Vehicles Directive)
- Material code: W3

Alternative surface finishings are available upon request. Contact STAUFF for further information.



Original STAUFF Cover Plate with Zinc/Nickel-Coating:  
No signs of corrosion after **1200 hours** in the salt spray chamber!



Original STAUFF Cover Plates with alternative surface finishings widely-used by competitors in the market (from left to right):

- Galvanisation and blue-chromating after **96 hours**
- Galvanisation and yellow-chromating after **192 hours**
- Zinc-coating, thick-film passivation and sealing after **192 hours**

In all three cases, signs of white and red rust / base metal corrosion are quite clearly visible! Please do not hesitate to contact STAUFF and ask for a detailed report.

## Thread Conversion Chart

## Metric ISO vs. Unified Coarse (UNC) Thread

Unless otherwise stated, all threaded parts available with Metric ISO thread or unified coarse (UNC) thread.

**Standard Series (DIN 3015, Part 1)**

Group STAUFF	DIN	Thread Metric ISO	Unified Coarse
1 to 8	0 to 8	M6	1/4–20 UNC

**Heavy Series (DIN 3015, Part 2)**

Group STAUFF	DIN	Thread Metric ISO	Unified Coarse
3S to 5S	1 to 3	M10	3/8–16 UNC
6S	4	M12	7/16–14 UNC
7S	5	M16	5/8–11 UNC
8S	6	M20	3/4–10 UNC
9S	7	M24	7/8–9 UNC
10S	8	M30	1-1/8–7 UNC
11S to 12S	9 to 10	M30	1-1/4–7 UNC

**Twin Series (DIN 3015, Part 3)**

Group STAUFF	DIN	Thread Metric ISO	Unified Coarse
1D	1	M6	1/4–20 UNC
2D to 5D	2 to 5	M8	5/16–18 UNC

## Property Classes / Grades of Bolts and Screws

**Hexagon Head Bolt**
**Socket Cap Screw**
**Slotted Head Screw**

Bolt / Screw Type	Material Code	Property Class / Grade	
		Metric ISO Threaded Bolts / Screws	Unified Coarse Threaded Bolts / Screws
Hexagon Head Bolt Type AS	W1, W2, W3	8.8 (according to DIN EN ISO 898)	5 (according to SAE J429)
	W4	A2-70 (according to DIN EN ISO 3506)	AISI 304 / B8 (according to ASTM A193)
	W5	A4-70 (according to DIN EN ISO 3506)	AISI 316 / B8M (according to ASTM A193)
Socket Cap Screw Type IS	W1, W2, W3	8.8 (according to DIN EN ISO 898)	5 (according to SAE J429)
	W4	A2-70 (according to DIN EN ISO 3506)	AISI 304 / B8 (according to ASTM A193)
	W5	A4-70 (according to DIN EN ISO 3506)	AISI 316 / B8M (according to ASTM A193)
Slotted Head Screw Type LI	W1, W2, W3	4.8 (according to DIN EN ISO 898)	2 (according to SAE J429)
	W4	A2-70 (according to DIN EN ISO 3506)	AISI 304 / B8 (according to ASTM A193)
	W5	A4-70 (according to DIN EN ISO 3506)	AISI 316 / B8M (according to ASTM A193)

Unless otherwise stated, the above mentioned property classes / grades apply as standards for bolts and screws supplied by STAUFF. The information indicate the minimum requirements; higher property classes are available upon request. Contact STAUFF for details.



## Basic Installation Instructions



### Installation on Weld Plate

Different types of weld plates are available for all STAUFF Clamps according to DIN 3015 as well as for most of the other series and many custom-designed special clamps.

- Place weld plates in their designated positions. Please make sure these positions are suitable for the expected loads.
- Mark the positions of the weld plates to ensure best alignment.
- Weld the weld plates into position. Elongated weld plates can also be mounted to their positions by using screws or bolts.
- Push bottom clamp half onto weld plate.
- Insert pipe, tube, hose, cable or any other type of line.
- Place second clamp half and cover plate (optional) on top and mount clamp assembly by using screws or bolts.

Unless otherwise stated, the bolt lengths indicated for clamps according to DIN 3015 refer to the installation on weld plates and mounting rails as well as multi-level (stacking) installation. For direct installation, different lengths may be required.



### Installation on Mounting Rail

STAUFF Mounting Rails are available in different heights. STAUFF Rail Nuts are available for all STAUFF Clamps according to DIN 3015 (Heavy Series up to STAUFF Group 6S only) as well as for many custom-designed special clamps.

- Place mounting rails in their designated positions. Please make sure these bases are suitable for the expected loads.
- Mark the positions of the mounting rails to ensure best alignment.
- Weld the mounting rails into position. Mounting rails can also be mounted to their positions by using side-mounting brackets with screws or bolts.
- Insert rail nuts into mounting rail and turn until stop to lock (Standard and Twin Series) or slide in rail nut (Heavy Series).
- Push bottom clamp half onto rail nuts.
- Insert pipe, tube, hose, cable or any other type of line.
- Place second clamp half and cover plate (optional) on top and mount clamp assembly by using screws or bolts.

The exact positions of the clamp assemblies can still be adjusted before being firmly bolted.



### Multi-Level (Stacking) Installation

Stacking bolts permit the multi-level assembly of clamps of identical group sizes. Safety locking plates inserted between the levels prevent the stacking bolts from turning. The Twin Series also allows stacking of different group sizes (STAUFF Groups 2D to 5D).

- Push bottom clamp half onto weld plate or rail nuts.
- Insert pipe, tube, hose, cable or any other type of line.
- Place second clamp half.
- Insert stacking bolts into the clamp assembly and tighten using the following tightening torques (or in a way that the clamp halves are in contact with the line over the entire internal contact surface):
  - Standard Series** 1 ... 2 N·m / .75 ... 1.5 ft·lb (hand-tightened)
  - Heavy Series** 5 N·m / 3.75 ft·lb
  - Twin Series** 1 ... 2 N·m / .75 ... 1.5 ft·lb (hand-tightened)
- Place safety locking plate on top of clamp assembly.
- Proceed with next levels. Top level to be assembled with cover plate and hexagon head bolts using the tightening torques as indicated on page 161.

STAUFF multi-level clamp assemblies can be mounted both to weld plates or to mounting rails (with rail nuts).

## Recommended Distance between Clamps

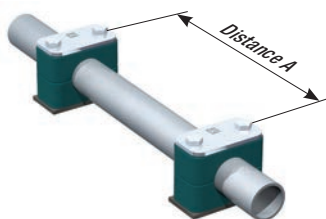

Please note: The recommended distances between clamps stated below are standard values and valid for static loads only.

Outside Diameter (mm)		Distance A (m)		Outside Diameter (mm)		Distance A (m)	
(mm)	(in)	(m)	(ft)	(mm)	(in)	(m)	(ft)
6,0 ... 12,7	.23 ... .50	1,00	3,28	114,0 ... 168,0	4.50 ... 6.60	5,00	16,40
12,7 ... 22,0	.50 ... .86	1,20	3,94	168,0 ... 219,0	6.60 ... 8.60	6,00	19,68
22,0 ... 32,0	.86 ... 1.25	1,50	4,92	219,0 ... 324,0	8.60 ... 12.70	6,70	21,98
32,0 ... 38,0	1.25 ... 1.50	2,00	6,56	324,0 ... 356,0	12.70 ... 14.00	7,00	22,96
38,0 ... 57,0	1.5 ... 2.25	2,70	8,86	356,0 ... 406,0	14.00 ... 16.00	7,50	24,60
57,0 ... 75,0	2.25 ... 2.95	3,00	9,84	406,0 ... 419,0	16.00 ... 16.50	8,20	26,90
75,0 ... 76,1	2.95 ... 3.00	3,50	11,48	419,0 ... 508,0	16.50 ... 20.00	8,50	27,88
76,1 ... 88,9	3.00 ... 3.50	3,70	12,14	508,0 ... 521,0	20.00 ... 20.50	9,00	29,52
88,9 ... 102,0	3.50 ... 4.00	4,00	13,12	521,0 ... 558,0	20.50 ... 22.00	10,00	32,80
102,0 ... 114,0	4.00 ... 4.50	4,50	14,76	558,0 ... 800,0	22.00 ... 31.50	12,50	41,00

## Installation next to Pipe Bends, Connectors / Couplings and Valves



Please note the following information on the installation of STAUFF Clamps next to pipe bends, connectors / couplings and valves:

#### Pipe Bends

Pipe bends should be supported by STAUFF Clamps as close to the bends as possible. Furthermore, it is recommended to design these clamps as fixed point clamps.

#### Connections / Couplings

The first clamp should be placed directly next to the connector / coupling. This protects the connector / coupling from vibrations.

#### Valves

If valves are incorporated in the pipelines, it is recommended that support is provided in front of and behind these valves.

Contact STAUFF for further information.



## Tightening Torques and Maximum Loads In Pipe Direction

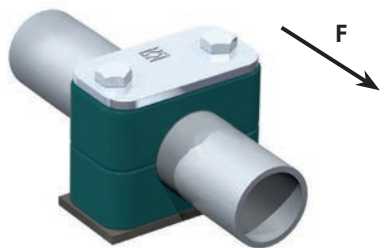

All tightening torques and maximum loads in pipe direction refer to STAUFF Clamp Bodies (profiled inside surface with tension clearance) with Cover Plates and Hexagon Head Bolts according to DIN EN ISO 4014/4017 (DIN 931/933).

The max. load in pipe direction (according to DIN 3015-10:1999) is an average value, determined by three tests at +23 °C / +73.4 °F with a steel pipe according to DIN EN 10220, St37 – rolled surface – taking static friction into consideration.

Sliding starts when the shown values (F) are reached.

## Standard Series (DIN 3015-1:1999)

Group	Hexagon Head Bolt DIN EN ISO 4014/4017 (DIN 931/933)		Polypropylene				Polyamide				Aluminium				
	STAUFF	DIN	Metric ISO Thread	Unified Coarse (UNC) Thread	Tightening Torque (N-m) (ft-lb)		Maximum Load in Pipe Direction F (kN) (lbf)		Tightening Torque (N-m) (ft-lb)		Maximum Load in Pipe Direction F (kN) (lbf)		Tightening Torque (N-m) (ft-lb)		Maximum Load in Pipe Direction F (kN) (lbf)
1	0	M6	1/4-20 UNC	8	6	0,6	135	10	7	0,6	135	12	9	3,5	787
1A	1	M6	1/4-20 UNC	8	6	1,1	247	10	7	0,7	157	12	9	4,2	944
2	2	M6	1/4-20 UNC	8	6	1,3	292	10	7	0,8	180	12	9	4,3	967
3	3	M6	1/4-20 UNC	8	6	1,4	315	10	7	1,6	360	12	9	4,9	1101
4	4	M6	1/4-20 UNC	8	6	1,5	337	10	7	1,7	382	12	9	5,0	1124
5	5	M6	1/4-20 UNC	8	6	1,9	427	10	7	2,0	450	12	9	7,3	1641
6	6	M6	1/4-20 UNC	8	6	2,0	450	10	7	2,5	562	12	9	8,9	2000
7	7	M6	1/4-20 UNC	8	6	2,3	517	10	7	3,2	719				
8	8	M6	1/4-20 UNC	8	6	2,6	585	10	7	3,5	787				

## Heavy Series (DIN 3015-2:1999)

Group	Hexagon Head Bolt DIN EN ISO 4014/4017 (DIN 931/933)		Polypropylene				Polyamide				Aluminium				
	STAUFF	DIN	Metric ISO Thread	Unified Coarse (UNC) Thread	Tightening Torque (N-m) (ft-lb)		Maximum Load in Pipe Direction F (kN) (lbf)		Tightening Torque (N-m) (ft-lb)		Maximum Load in Pipe Direction F (kN) (lbf)		Tightening Torque (N-m) (ft-lb)		Maximum Load in Pipe Direction F (kN) (lbf)
3S	1	M10	3/8-16 UNC	12	9	1,6	360	20	15	4,2	944	30	22	12,1	2720
4S	2	M10	3/8-16 UNC	12	9	2,9	652	20	15	4,5	1044	30	22	15,1	3395
5S	3	M10	3/8-16 UNC	15	11	3,3	742	25	18	5,1	1146	35	26	15,5	3485
6S	4	M12	7/16-14 UNC	30	22	8,2	1843	40	30	9,3	2090	55	41	29,5	6609
7S	5	M16	5/8-11 UNC	45	33	11,0	2472	55	41	15,8	3551	120	86	34,9	7845
8S	6	M20	3/4-10 UNC	80	59	14,0	3147	150	111	21,0	4720	220	162	50,0	11240
9S	7	M24	7/8-9 UNC	110	81	28,0	6300	200	148	32,0	7193	250	184	70,6	15871
10S	8	M30	1-1/8-7 UNC	180	133	40,0	8992	350	258	48,0	10790	500	369	84,5	18996
11S	9	M30	1-1/4-7 UNC	200	148	119,0	26752	370	273	125,0	27650	500	369	181,5	40802
12S	10	M30	1-1/4-7 UNC	270	199	168,0	37767	450	332	180,0	40465	600	443	244,5	54965

## Twin Series (DIN 3015-2:1999)

Group	Hexagon Head Bolt DIN EN ISO 4014/4017 (DIN 931/933)		Polypropylene				Polyamide				
	STAUFF	DIN	Metric ISO Thread	Unified Coarse (UNC) Thread	Tightening Torque (N-m) (ft-lb)		Maximum Load in Pipe Direction F (kN) (lbf)		Tightening Torque (N-m) (ft-lb)		Maximum Load in Pipe Direction F (kN) (lbf)
1D	1	M6	1/4-20 UNC	5	4	0,9	202	5	4	0,9	202
2D	2	M8	5/16-18 UNC	12	9	2,1	472	12	9	2,2	495
3D	3	M8	5/16-18 UNC	12	9	1,9	427	12	9	2,0	450
4D	4	M8	5/16-18 UNC	12	9	2,7	607	12	9	2,9	652
5D	5	M8	5/16-18 UNC	8	6	1,7	382	8	6	2,5	562



### Dimensions and Weights of Clamp Assemblies

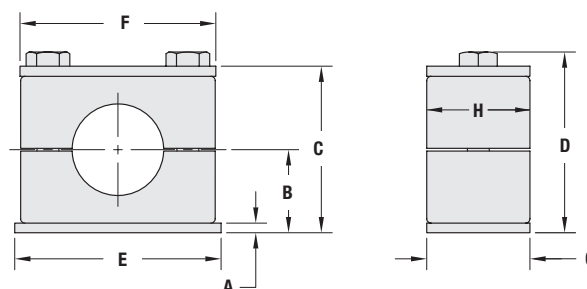

#### Standard Series (DIN 3015, Part 1)

Group	STAUFF	DIN	Dimensions (mm/in)								Weight per 100 Pcs. SP-**-PP-DP-AS (kg/lbs)			
			A	B		C		D		E		F	G	H
				Profilled Design	Type H (Smooth)	Profilled Design	Type H (Smooth)	Profilled Design	Type H (Smooth)					
1	0	3	16,5	16	33	32	37	36	31,5	28	30	30	6,20	
		.12	.65	.63	1.30	1.26	1.46	1.42	1.24	1.10	1.18	1.18	13,64	
1A	1	3	16,5	16	33	32	37	36	36	34	30	30	8,10	
		.12	.65	.63	1.30	1.26	1.46	1.42	1.41	1.33	1.18	1.18	17,82	
2	2	3	19,5	19	39	38	43	42	42	40,5	30	30	9,40	
		.12	.77	0.75	1.54	1.50	1.69	1.65	1.65	1.59	1.18	1.18	20,68	
3	3	3	21	20,75	42	41,5	46	45,5	50	48	30	30	11,20	
		.12	.83	.82	1.65	1.64	1.81	1.80	1.96	1.88	1.18	1.18	24,64	
4	4	3	24	23,75	48	47,5	52	51,5	60	57	30	30	13,70	
		.12	.94	.94	1.89	1.87	2.05	2.03	2.36	2.24	1.18	1.18	30,14	
5	5	3	32	31,25	64	62,5	68	66,5	71	70	30	30	17,10	
		.12	1.26	1.23	2.52	2.46	2.68	2.62	2.79	2.75	1.18	1.18	37,62	
6	6	3	36	35,25	72	70,5	76	74,5	88	86	30	30	21,30	
		.12	1.42	1.39	2.83	2.78	2.99	2.94	3.46	3.38	1.18	1.18	46,86	
7	7	5	51,5	51	103	102	107	106	122	118	30	30	42,10	
		.20	2.03	2.01	4.06	4.02	4.21	4.17	4.81	4.65	1.18	1.18	92,62	
8	8	5	64	63	128	126	132	130	148	144	30	30	44,00	
		.20	2.52	2.48	5.04	4.96	5.20	5.12	5.83	5.67	1.18	1.18	96,80	

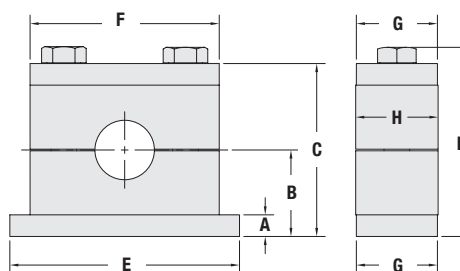

#### Heavy Series (DIN 3015, Part 2)

Group	STAUFF	DIN	Dimensions (mm/in)								F		G	H	Weight per 1 Pc. SPAL-**-PP-DPAL-AS (kg/lbs)
			A	B		C		D		PP/PA/SA	AL				
				Profilled Design	Type H (Smooth)	Profilled Design	Type H (Smooth)	Profilled Design	Type H (Smooth)						
3S	1	8	24	23,25	48	46,5	54,4	52,9	74	55	56	30	30,5	0,32	
		.31	.94	.92	1.89	1.83	2.14	2.09	2.91	2.16	2.20	1.18	1.20	.70	
4S	2	8	32	31,25	64	62,5	70,4	68,9	86	70	70	30	30,5	0,40	
		.31	1.26	1.23	2.52	2.46	2.77	2.72	3.39	2.76	2.76	1.18	1.20	.88	
5S	3	8	38	37	76	74	82,4	80,4	100	85	85	30	30,5	0,49	
		.31	1.50	1.46	2.99	2.91	3.24	3.17	3.94	3.35	3.35	1.18	1.20	1,08	
6S	4	10	54,5	53,5	109	107	116,5	114,5	140	115	120	45	45	1,21	
		.39	2.15	2.11	4.29	4.21	4.59	4.51	5.51	4.53	4.72	1.77	1.77	2,66	
7S	5	10	70		140		150		180	154	152	60	60	2,30	
		.39	2.76		5.51		5.91		7.09	6.06	5.98	2.36	2.36	5,06	
8S	6	15	99		198		210,5		226	206	208	80	80	5,56	
		.59	3.90		7.80		8.29		8.90	8.11	8.19	3.15	3.15	12,26	
9S	7	15	115		230		245		270	251	255	90	91	7,97	
		.59	4.53		9.06		9.65		10.63	9.88	10.04	3.54	3.58	17,58	
10S	8	25	160		320		338,7		340	336	326	120	120	22,16	
		.98	6.30		12.60		13.33		13.39	13.22	12.83	4.72	4.72	48,75	
11S	9	30	235		470		488,7		520	470	470	160	162	54,11	
		1.18	9.25		18.50		19.24		20.47	18.50	18.50	6.30	6.38	119,04	
12S	10	30	295		590		608,7		680	630	630	180	182	77,40	
		1.18	11.61		23.23		23.96		26.77	24.80	24.80	7.09	7.16	170,28	

0

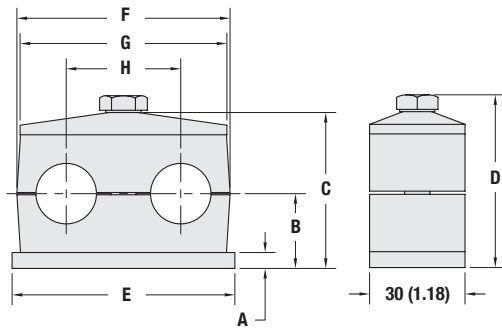

**Dimensions & Weights of Clamp Assemblies**

**Twin Series (DIN 3015, Part 3)**

Group	DIN	Dimensions (mm/in)								E	F	G	H	Weight per 100 Pcs. SP-**-**-PP-GD-AS (kg/lbs)
		A	B		C		D							
			Profiled Design	Type H (Smooth)	Profiled Design	Type H (Smooth)	Profiled Design	Type H (Smooth)						
1D	1	3	16,5	16,25	37	36,5	41	40,5	37	36	34	20	7,60	
		.12	.65	.64	1.46	1.44	1.61	1.59	1.46	1.42	1.34	.79	16.72	
2D	2	5	18,5	18,25	39	38,5	44	43,5	55	53	52	29	13,50	
		.20	.73	.72	1.54	1.52	1.73	1.71	2.17	2.09	2.05	1.14	29.70	
3D	3	5	23,5	23,25	49	48,5	54	53,5	70	67	65	36	17,70	
		.20	.93	.92	1.93	1.91	2.13	2.11	2.76	2.64	2.56	1.42	38.94	
4D	4	5	25	24	52	50	57	55	85	80	79	45	20,40	
		.20	.98	.94	2.05	1.97	2.24	2.17	3.35	3.15	3.11	1.77	44.88	
5D	5	5	31,5	31	65	64	70	69	110	106	102	56	27,70	
		.20	1.24	1.22	2.56	2.52	2.76	2.72	4.33	4.17	4.02	2.20	60.94	

**Packaging Units (Selection)**
**Standard Series (DIN 3015, Part 1)**
**Clamp Bodies** (Polypropylene / Polyamide)

Group	STAUFF	DIN	Quantity per Bag (in Pcs.)
1 - 6	0 - 6		25
7 + 8	7 + 8		10

**Clamp Bodies** (Aluminium)

Group	STAUFF	DIN	Quantity per Bag (in Pcs.)
1 - 5	0 - 5		25
6	6		10

**Weld Plates** (Type SP)  
**Cover Plates** (Type DP)

Group	STAUFF	DIN	Quantity per Bag (in Pcs.)
1 - 6	0 - 6		25
7 + 8	7 + 8		10

**Hexagon Rail Nut** (Type SM)  
**Channel Rail Adaptor** (Type CRA)

Group	STAUFF	DIN	Quantity per Bag (in Pcs.)
1 - 8	0 - 8		50

**Heavy Series (DIN 3015, Part 2)**
**Clamp Bodies** (Polypropylene / Polyamide)

Group	STAUFF	DIN	Quantity per Bag (in Pcs.)
3S - 6S	1 - 4		20
7S	5		10
8S - 12S	6 - 10		1

**Clamp Bodies** (Aluminium)

Group	STAUFF	DIN	Quantity per Bag (in Pcs.)
3S - 6S	1 - 4		20
7S	5		10
8S - 12S	6 - 10		1

**Weld Plates** (Type SPAL)  
**Cover Plates** (Type DPAL)

Group	STAUFF	DIN	Quantity per Bag (in Pcs.)
3S - 6S	1 - 4		20
7S	5		10
8S - 12S	6 - 10		1

**Mounting Rail Nut** (Type GMV)  
**Channel Rail Adaptor** (Type CRA)

Group	STAUFF	DIN	Quantity per Bag (in Pcs.)
3S - 6S	1 - 4		40

**Twin Series (DIN 3015, Part 3)**
**Clamp Bodies** (Polypropylene / Polyamide)

Group	STAUFF	DIN	Quantity per Bag (in Pcs.)
1D - 4D	1 - 4		25
5D	5		10

**Weld Plates** (Type SP)  
**Cover Plates** (Type GD)

Group	STAUFF	DIN	Quantity per Bag (in Pcs.)
1D - 4D	1 - 4		25
5D	5		10

**Hexagon Rail Nut** (Type SM)  
**Channel Rail Adaptor** (Type CRA)

Group	STAUFF	DIN	Quantity per Bag (in Pcs.)
1D	1		50
2D - 5D	2 - 5		25

Contact STAUFF and ask for standard packaging units for further components or special packaging options.



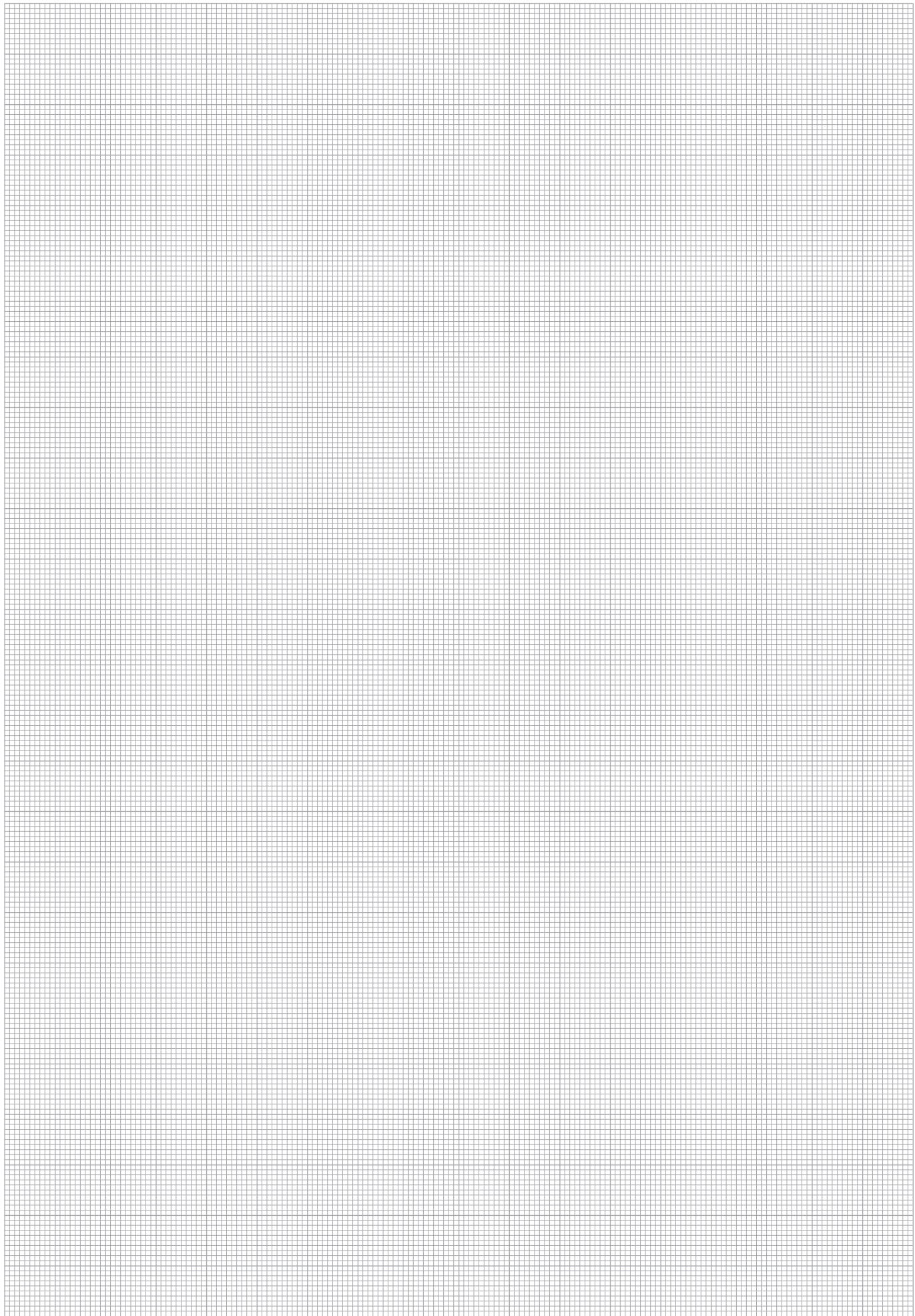

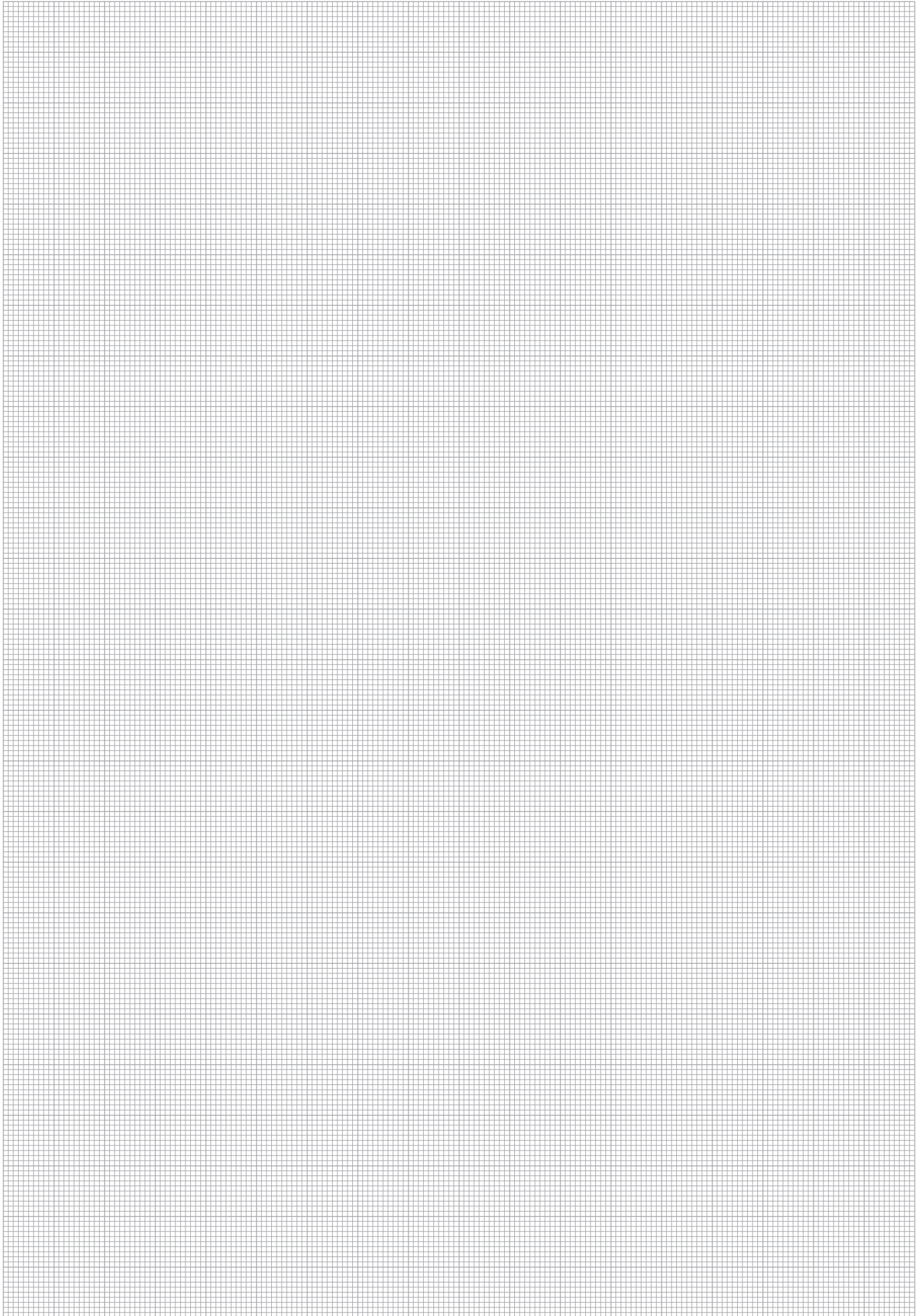



<b>Product-Specific Abbreviations</b>	<b>168</b>
---------------------------------------	------------

<b>Global Contact Directory</b>	<b>170</b>
---------------------------------	------------



## Product-Specific Abbreviations

Abbreviation	Product Category	Product Description	Page
ACT	STAUFF ACT Clamps: Anti-Corrosion Technology	Clamp Body - Standard Series	74
ACT	STAUFF ACT Clamps: Anti-Corrosion Technology	Clamp Body - Twin Series	82
AF	Standard Series according to DIN 3015, Part 1	Stacking Bolt	29
AF	Heavy Series according to DIN 3015, Part 2	Stacking Bolt	47
AF	Twin Series according to DIN 3015, Part 3	Stacking Bolt	61
AF	Heavy Twin Series	Stacking Bolt	68
AG	Other Types of Clamps	Agriculture Twin Series	150
AL	Technical Appendix	Standard Clamp Body Material	154
AS	Standard Series according to DIN 3015, Part 1	Hexagon Head Bolt	26
AS	Heavy Series according to DIN 3015, Part 2	Hexagon Head Bolt	45
AS	Twin Series according to DIN 3015, Part 3	Hexagon Head Bolt	59
AS	Heavy Twin Series	Hexagon Head Bolt	68
AS	Light Series	Hexagon Head Bolt	115
BSP	Standard Series according to DIN 3015, Part 1	Bridge Weld Plate	22
CB420-50	STAUFF Bond: Adhesive Bonded Fastening	Adhesive Cartridge	100
CB420-50E	STAUFF Bond: Adhesive Bonded Fastening	Adhesive Cartridge	100
CC	Standard Series according to DIN 3015, Part 1	Clamp Body - Compact Design	19
CHC	Standard Series according to DIN 3015, Part 1	Clamp Body for Conduit Hoses	18
CRA	Standard Series according to DIN 3015, Part 1	Channel Rail Adaptor	25
CRA	Heavy Series according to DIN 3015, Part 2	Channel Rail Adaptor	43
CRA	Twin Series according to DIN 3015, Part 3	Channel Rail Adaptor	58
CRA	Heavy Twin Series	Channel Rail Adaptor	68
DIN1592	Metal DIN Clamps	Heavy Saddle with Tension Clearance - Single-Bolt Design	138
DIN1593	Metal DIN Clamps	Heavy Saddle with Tension Clearance - Two-Bolt Design	139
DIN1596	Metal DIN Clamps	Light Saddle with Tension Clearance - Single-Bolt Design	140
DIN1597	Metal DIN Clamps	Light Saddle with Tension Clearance - Two-Bolt Design	141
DIN3567-A	Metal DIN Clamps	Metal Pipe Clamp with Tension Clearance	136
DIN3567-B	Metal DIN Clamps	Metal Pipe Clamp with Tension Clearance (Extended to One Side)	137
DIT-SR6-SWG	STAUFF SWG: Stud Welding System	Distance Tube	95
DKS	Construction Series	Construction Series Clamp	144
DKSV	Construction Series	Construction Series Clamp (for Anchor Bolt Fastening)	145
DP	Standard Series according to DIN 3015, Part 1	Cover Plate	26
DPAL	Heavy Series according to DIN 3015, Part 2	Cover Plate for Single Clamps	44
DPAS	Heavy Series according to DIN 3015, Part 2	Cover Plate for Double Clamps	44
DPAS	Heavy Twin Series	Cover Plate	67
DPL	Light Series	Cover Plate	119
DS	Other Types of Clamps	Compact Twin Series	150
DSP	Standard Series according to DIN 3015, Part 1	Twin Weld Plate	21
EP	Standard Series according to DIN 3015, Part 1	Insert	28
EPDM	Technical Appendix	Standard Clamp Insert Materials	155
ES	Standard Series according to DIN 3015, Part 1	Insert	28
FB	Flat Steel and Round Steel U-Bolt Clamps	Flat Steel U-Bolt	126
GD	Twin Series according to DIN 3015, Part 3	Cover Plate	58
GMV	Heavy Series according to DIN 3015, Part 2	Mounting Rail Nut	42
GMV	Heavy Twin Series	Mounting Rail Nut	68
IS	Standard Series according to DIN 3015, Part 1	Socket Cap Screw	28
IS	Heavy Series according to DIN 3015, Part 2	Socket Cap Screw	45
IS	Twin Series according to DIN 3015, Part 3	Socket Cap Screw	59
KS	Construction Series	Construction Series Clamp	144
KSV	Construction Series	Construction Series Clamp (for Anchor Bolt Fastening)	145
LBBU	Light Series	Clamp Body - Single Design	112
LBBU	Light Series	Clamp Body - Twin Design	113
LBBU-DP	Light Series	Cover Plate	115
LBBU-HUE	Light Series	Sleeve	114
LBBU-SP	Light Series	Weld Plate	114
LB	Light Series	Clamp Body - Single Design	116
LBG	Light Series	Clamp Body - Twin Design	117
LBU	Light Series	Clamp Body - Twin Design	117
LI	Standard Series according to DIN 3015, Part 1	Slotted Head Screw	28
LN	Light Series	Clamp Body - Single Design	118
LNGF	Light Series	Clamp Body - Twin Design	119
LNUF	Light Series	Clamp Body - Twin Design	119
NRC	Standard Series according to DIN 3015, Part 1	Noise Reduction Clamp	17



## Product-Specific Abbreviations

Abbreviation	Product Category	Product Description	Page
PA	Technical Appendix	Standard Clamp Body Material	154
PA-V0	Technical Appendix	Special Clamp Body Material	156
PP	Technical Appendix	Standard Clamp Body Material	154
PP6853	Technical Appendix	Special Clamp Body Material	156
PP-DA	Technical Appendix	Special Clamp Body Material	156
PP-V0	Technical Appendix	Special Clamp Body Material	156
RAP	Standard Series according to DIN 3015, Part 1	Group Weld Plate	21
RAP	Twin Series according to DIN 3015, Part 3	Group Weld Plate	55
RAP-MGR	Standard Series according to DIN 3015, Part 1	Multi-Group Weld Plate	23
RB	Flat Steel and Round Steel U-Bolt Clamps	Round Steel U-Bolt	128
RBD	Flat Steel and Round Steel U-Bolt Clamps	Round Steel U-Bolt (DIN 3570, Type A)	132
RF	Other Types of Clamps	Pipe / Tube Bushing	151
RI	Standard Series according to DIN 3015, Part 1	Elastomer Insert	16
RI	Heavy Series according to DIN 3015, Part 2	Elastomer Insert	39
RI	Heavy Twin Series	Clamp Body with Elastomer Inserts	66
RUK	Flat Steel and Round Steel U-Bolt Clamps	Plastic Pipe Saddle (Short) for Flat Steel U-Bolts	126
RUK	Flat Steel and Round Steel U-Bolt Clamps	Plastic Pipe Saddle (Short) for Round Steel U-Bolts	128
RUL	Flat Steel and Round Steel U-Bolt Clamps	Plastic Pipe Saddle (Long) for Round Steel U-Bolts	130
SA	Technical Appendix	Standard Clamp Body Material	154
SA	Technical Appendix	Standard Clamp Insert Materials	155
SA-V0	Technical Appendix	Special Clamp Body Material	156
SBD	STAUFF Bond: Adhesive Bonded Fastening	Manual Adhesive Dispenser	101
SBDS-81	STAUFF Bond: Adhesive Bonded Fastening	Dispenser Slide	101
SBMT	STAUFF Bond: Adhesive Bonded Fastening	Mixing Tip	101
SBP	STAUFF Bond: Adhesive Bonded Fastening	STAUFF Bond Plate for DIN 3015 Clamps	99
SCS	Other Types of Clamps	Channel Rail	149
SI	Standard Series according to DIN 3015, Part 1	Safety Washer	27
SI	Heavy Series according to DIN 3015, Part 2	Safety Washer	46
SI	Twin Series according to DIN 3015, Part 3	Safety Locking Plate	60
SI	Heavy Twin Series	Socket Cap Screw	68
SIG	Standard Series according to DIN 3015, Part 1	Safety Locking Plate	29
SIP	Heavy Series according to DIN 3015, Part 2	Safety Locking Plate	47
SIP	Heavy Twin Series	Safety Locking Plate	68
SIV	Twin Series according to DIN 3015, Part 3	Safety Locking Plate	60
SM	Standard Series according to DIN 3015, Part 1	Hexagon Rail Nut	24
SM	Twin Series according to DIN 3015, Part 3	Hexagon Rail Nut	56
SMG	Standard Series according to DIN 3015, Part 1	Hexagon Rail Nut	24
SMG	Twin Series according to DIN 3015, Part 3	Hexagon Rail Nut	56
SP	Standard Series according to DIN 3015, Part 1	Weld Plate	20
SP	Twin Series according to DIN 3015, Part 3	Single Weld Plate	55
SPAD	Heavy Twin Series	Weld Plate	67
SPAL	Heavy Series according to DIN 3015, Part 2	Weld Plate for Single Clamps	40
SPAL-DUEB	Heavy Series according to DIN 3015, Part 2	Elongated Weld Plate for Single Clamps	41
SPAS-DUEB	Heavy Series according to DIN 3015, Part 2	Weld Plate for Double Clamps	40
SPAS-DUEB	Heavy Series according to DIN 3015, Part 2	Elongated Weld Plate for Double Clamps	41
SPC	Other Types of Clamps	Cushion Clamp	148
SPV	Standard Series according to DIN 3015, Part 1	Elongated Weld Plate	20
STC	Other Types of Clamps	Cushion Clamp	148
STSV	Heavy Series according to DIN 3015, Part 2	Mounting Rail	42
STSV	Heavy Twin Series	Mounting Rail	68
SWG-AGS	STAUFF SWG: Stud Welding System	Distance Adaptor	95
SWG-CTH-11-M6	STAUFF SWG: Stud Welding System	Cable Tie Holder	93
SWG-CTH-30-M6-1	STAUFF SWG: Stud Welding System	Cable Tie / Tension Belt Holder	93
SWG-CTH-30-M6-2	STAUFF SWG: Stud Welding System	Cable Tie / Tension Belt Holder	93
SWG-DIP	STAUFF SWG: Stud Welding System	Distance Plate for DIN 3015 Clamps	93
SWG-GC	STAUFF SWG: Stud Welding System	Ground Cable	95
SWG-SF	STAUFF SWG: Stud Welding System	Weld Stud with Female Thread	92
SWG-SR6	STAUFF SWG: Stud Welding System	Stud Retainer	95
SWG-WG	STAUFF SWG: Stud Welding System	Weld Gun - Arc Ignition	94
SWG-WI06	STAUFF SWG: Stud Welding System	Weld Inverter	94
SWG-WI06-Starterkit	STAUFF SWG: Stud Welding System	Starterkit	94
TS	Standard Series according to DIN 3015, Part 1	Mounting Rail	24
TS	Twin Series according to DIN 3015, Part 3	Mounting Rail	57
VK	Standard Series according to DIN 3015, Part 1	Clamp Body - Rectangular Design for Proximity Switches	19
WSP	Standard Series according to DIN 3015, Part 1	Angled Weld Plate	22
ZR	Saddle / Piggyback Clamps	Custom-Designed Saddle / Piggyback Clamps	122
ZR-518	Saddle / Piggyback Clamps	Saddle / Piggyback Clamp	122



## Global Contact Directory

STAUFF products and services are globally available through wholly-owned subsidiaries and a tight network of authorised distributors and representatives in all major industrial regions of the world.

Contact information on this page may be subject to changes and additions over time. Frequently updated and complete contact information can always be found at [www.stauff.com](http://www.stauff.com).

### Germany



#### Walter Stauffenberg GmbH & Co. KG

Im Ehrenfeld 4  
58791 Werdohl  
Tel.: +49 2392 91 60  
Fax: +49 2392 91 61 60  
E-Mail: [sales@stauff.com](mailto:sales@stauff.com)  
[www.stauff.com](http://www.stauff.com)



Neuenrade-Küntrop Logistics Centre  
Wasserburgstraße 35  
58809 Neuenrade



Plettenberg-Ohle Production Site  
Lennastraße 2  
58840 Plettenberg



#### Voswinkel GmbH

Neugrünenthal  
58540 Meinerzhagen  
Tel.: +49 2354 70 50  
Fax: +49 2354 70 51 50  
E-Mail: [info@voswinkel.net](mailto:info@voswinkel.net)  
[www.voswinkel.net](http://www.voswinkel.net)

### Europe

#### France

##### STAUFF S.A.S.

230, Avenue du Grain d'Or  
Z.I. de Vineuil - Blois Sud  
41354 Vineuil-cedex  
Tel.: +33 2 54 50 55 50  
Fax: +33 2 54 42 29 19  
E-Mail: [direction@stauffsa.com](mailto:direction@stauffsa.com)  
[www.stauff.fr](http://www.stauff.fr)

#### Ireland

##### STAUFF UK Ltd.

Block B, 9 Ferguson Drive  
Knockmore Hill Industrial Estate  
Lisburn, County Antrim, BT28 2EX  
Tel.: +44 2892 60 69 00  
Fax: +44 2892 60 26 88  
E-Mail: [sales@stauffireland.com](mailto:sales@stauffireland.com)  
[www.stauff.co.uk](http://www.stauff.co.uk)

#### Italy

##### STAUFF Italia s.r.l

Via Borima 21 (Frazione Borima)  
23867 Suello (LC)  
Tel.: +39 031 65 84 94  
Fax: +39 031 65 50 05  
E-Mail: [sales@stauff.it](mailto:sales@stauff.it)  
[www.stauff.it](http://www.stauff.it)

#### Poland

##### STAUFF Polska Sp. z o.o.

Miszewko 43 A  
80-297 Banino  
Tel.: +48 58 660 11 60  
Fax: +48 58 629 79 52  
E-Mail: [sales@stauff.pl](mailto:sales@stauff.pl)  
[www.stauff.pl](http://www.stauff.pl)

#### Russian Federation

##### STAUFF LLC

Building 1  
19, Leninskaya Sloboda  
Moscow, 115280  
Tel.: +7 495 276 16 50  
Fax: +7 495 276 16 51  
E-Mail: [sales@stauff.ru](mailto:sales@stauff.ru)  
[www.stauff.ru](http://www.stauff.ru)

#### United Kingdom

##### STAUFF UK Ltd.

500, Carlisle Street East  
Off Downgate Drive  
Sheffield, S4 8BS  
Tel.: +44 114 251 85 18  
Fax: +44 114 251 85 19  
E-Mail: [sales@stauff.co.uk](mailto:sales@stauff.co.uk)  
[www.stauff.co.uk](http://www.stauff.co.uk)

##### STAUFF UK Ltd.

Badentoy Avenue  
Badentoy Industrial Estate  
Portlethen, Aberdeen, AB12 4YB  
Tel.: +44 1224 78 61 66  
Fax: +44 1224 78 61 77  
E-Mail: [sales@stauffscotland.co.uk](mailto:sales@stauffscotland.co.uk)  
[www.stauff.co.uk](http://www.stauff.co.uk)

##### STAUFF UK Ltd.

Unit 9, Southampton Trade Park  
Third Avenue, Millbrook  
Southampton, SO15 0AD  
Tel.: +44 2380 69 87 00  
Fax: +44 2380 69 87 01  
E-Mail: [sales@stauffsouthampton.co.uk](mailto:sales@stauffsouthampton.co.uk)  
[www.stauff.co.uk](http://www.stauff.co.uk)

Further branch offices in  
Engels, Volzhskiy, Magnitogorsk,  
Nizhny Novgorod and St. Petersburg.

### North America

#### Canada

##### STAUFF Canada Ltd.

866 Milner Avenue  
Scarborough  
Ontario M1B 5N7  
Tel.: +1 416 282 46 08  
Fax: +1 416 282 30 39  
E-Mail: [sales@stauffcanada.com](mailto:sales@stauffcanada.com)  
[www.stauffcanada.com](http://www.stauffcanada.com)

#### United States

##### STAUFF Corporation

7 Wm. Demarest Place  
Waldwick, 07463-1542  
New Jersey  
Tel.: +1 201 444 78 00  
Fax: +1 201 444 78 52  
E-Mail: [sales@stauffusa.com](mailto:sales@stauffusa.com)  
[www.stauffusa.com](http://www.stauffusa.com)

Further branch office in  
Canton, Michigan.

### South America

#### Brazil

##### STAUFF Brasil Ltda.

Avenida Gupê 10767  
Galpão 2 - Bloco A  
Barueri, São Paulo, CEP 06422-120  
Tel.: +55 11 47 72 72 00  
Fax: +55 11 47 72 72 10  
E-Mail: [stauff@stauffbrasil.com](mailto:stauff@stauffbrasil.com)  
[www.stauffbrasil.com](http://www.stauffbrasil.com)



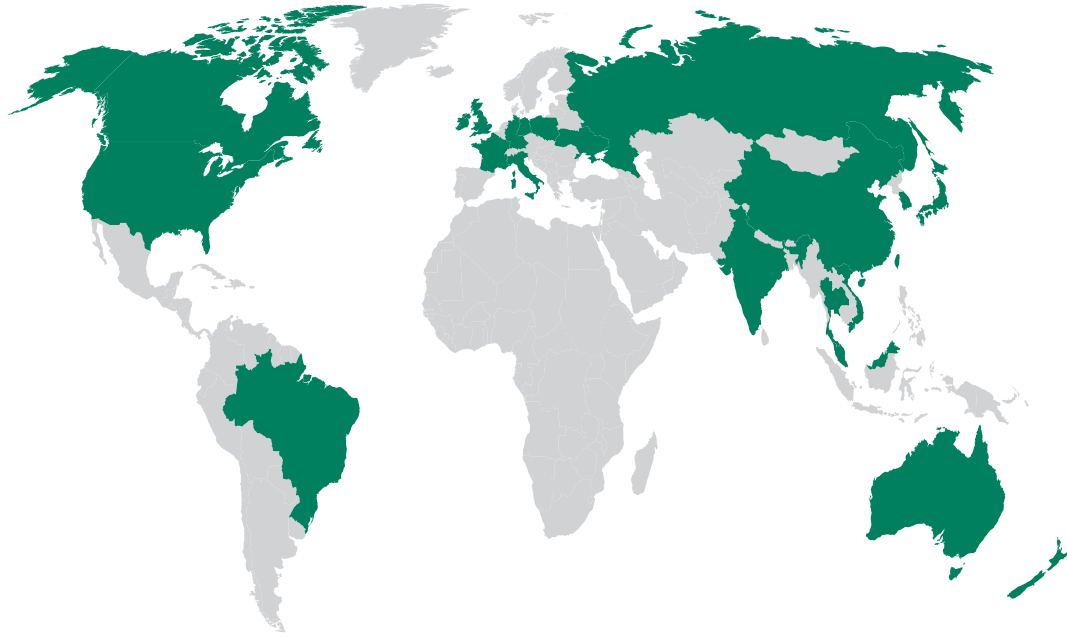

## Asia

### China

#### STAUFF CHINA

Building 1, No. 128, Die Qiao Road  
Jushuo Industrial Zone, Kang Qiao  
Shanghai, 201319  
Tel.: +86 21 68 18 70 00  
Fax: +86 21 68 18 71 36  
E-Mail: [info@stauff.com.cn](mailto:info@stauff.com.cn)  
[www.stauff.com.cn](http://www.stauff.com.cn)

Further branch offices in Beijing,  
Changsha, Chengdu, Changchun,  
Chongqing, Jinan, Harbin, Guangzhou,  
Shenyang, Wuhan, Xian and Xuzhou.

### India

#### STAUFF India Pvt. Ltd.

Gat no. 26/1 & 27, Sanghar Warehousing  
Pune - Nagar Road  
Lonikand - 412216  
Tel.: +91 20 6731 4900  
Fax: +91 20 6731 4905  
E-Mail: [sales@stauffindia.com](mailto:sales@stauffindia.com)  
[www.stauffindia.com](http://www.stauffindia.com)

### Korea

#### STAUFF Korea Ltd.

105, Hwajeonsandan 5-ro  
Gangseo-gu  
Busan, 46739  
Tel.: +82 51 266 6666  
Fax: +82 51 266 8866  
E-Mail: [info@stauff.co.kr](mailto:info@stauff.co.kr)  
[www.stauff.co.kr](http://www.stauff.co.kr)

### Malaysia

#### STAUFF South East Asia Sdn Bhd

No. 8, Jalan SS13/6A  
Subang Jaya Industrial Estate  
47500 Subang Jaya  
Tel.: +60 3 5637 78 88  
Fax: +60 3 5636 78 90  
E-Mail: [sales@stauff.com.my](mailto:sales@stauff.com.my)  
[www.stauff.com.my](http://www.stauff.com.my)

### Thailand

#### STAUFF (Thailand) Co., Ltd.

10 Soi On-Nut 74/4  
Pravet District  
Bangkok 10250  
Tel.: +66 2 721 73 23 / 24  
Fax: +66 2 721 73 35  
E-Mail: [sales@stauff.co.th](mailto:sales@stauff.co.th)  
[www.stauff.co.th](http://www.stauff.co.th)

### Vietnam

#### STAUFF Vietnam Ltd.

2nd Floor, CT-IN Building  
#435 Hoang Van Thu Street  
Tan Binh District, Ho Chi Minh City  
Tel.: +84 8 3948 10 41 / 42  
Fax: +84 8 3948 10 44  
E-Mail: [sales@stauff.com.vn](mailto:sales@stauff.com.vn)  
[www.stauff.com.vn](http://www.stauff.com.vn)

## Oceania

### Australia

#### STAUFF Corporation Pty Ltd

24-26 Doyle Avenue  
Unanderra NSW 2526  
Tel.: +61 2 4271 9000  
Fax: +61 2 4271 8432  
E-Mail: [sales@stauff.com.au](mailto:sales@stauff.com.au)  
[www.stauff.com.au](http://www.stauff.com.au)

Further branch offices in  
Adelaide, Brisbane, Melbourne  
and Sydney.

### New Zealand

#### STAUFF Corporation (NZ) Ltd.

Unit D, 103 Harris Road  
East Tamaki, Auckland 2013  
Tel.: +64 9 271 48 12  
Fax: +64 9 271 48 32  
E-Mail: [sales@stauff.co.nz](mailto:sales@stauff.co.nz)  
[www.stauff.co.nz](http://www.stauff.co.nz)



Introduction

Standard Series according to DIN 3015, Part 1

Heavy Series according to DIN 3015, Part 2

Twin Series according to DIN 3015, Part 3

Heavy Twin Series

STAUFF ACT Clamps: Anti-Corrosion Technology

STAUFF SWG: Stud Welding System

STAUFF Bond: Adhesive Bonded Fastening

Custom-Designed Special Clamps

Light Series

Saddle / Piggyback Clamps

Flat Steel and Round Steel U-Bolt Clamps

Metal DIN Clamps

Construction Series

Other Types of Clamps

Technical Appendix

Appendix



## Catalogue 1 STAUFF Clamps

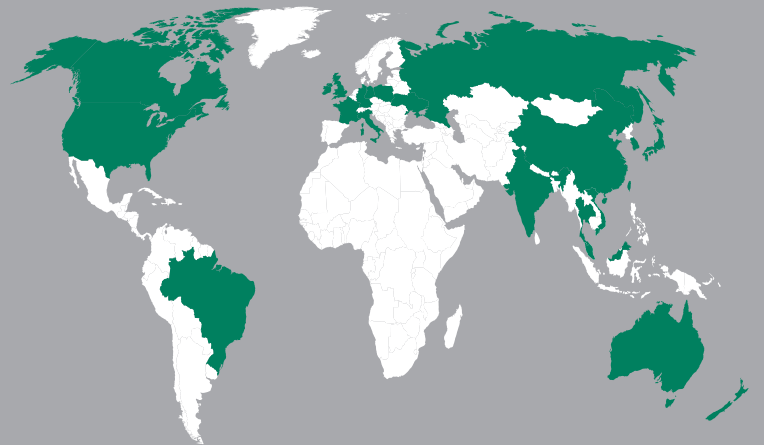

### Germany

Walter Stauffenberg GmbH & Co. KG  
Im Ehrenfeld 4  
58791 Werdohl  
Tel.: +49 2392 91 60  
Fax: +49 2392 91 61 60  
E-Mail: sales@stauff.com

STAUFF products and services are globally available through wholly-owned subsidiaries and a tight network of authorised distributors and representatives in all major industrial regions of the world.

You can find detailed contact information on the last two pages of this product catalogue or at

[www.stauff.com](http://www.stauff.com)